



In association with

Architecture Building Culture LLC
CH2M Hill Engineers, Inc.
Corgan Associates, Inc.
Corich Group LLC
C&N Consultants, Inc.
Lea+Elliott
Logplan
PRR
Quantum Spatial
Synergy Consultants, Inc.



TECHNICAL MEMORANDUM No.5 FINAL

FACILITY REQUIREMENTS

Seattle-Tacoma International Airport

Prepared for
Port of Seattle
Seattle, Washington

June 2017



In association with

Architecture Building Culture LLC
CH2M Hill Engineers, Inc.
Corgan Associates, Inc.
Corich Group LLC
C&N Consultants, Inc.
Lea+Elliott
Logplan
PRR
Quantum Spatial
Synergy Consultants, Inc.



TECHNICAL MEMORANDUM No.5 FINAL

FACILITY REQUIREMENTS

Seattle-Tacoma International Airport

Prepared for
Port of Seattle
Seattle, Washington

June 2017

CONTENTS

| | Page |
|--|------|
| Introduction and Summary | 1-1 |
| 1.1 Background and Purpose..... | 1-1 |
| 1.2 Planning Activity Levels..... | 1-1 |
| 1.3 Summary of Requirements | 1-2 |
| 1.3.1 Airfield..... | 1-2 |
| 1.3.2 Passenger Terminal | 1-5 |
| 1.3.3 Ground Access and Parking..... | 1-9 |
| 1.3.4 Air Cargo..... | 1-11 |
| 1.3.5 Airline Support..... | 1-12 |
| 1.3.6 Airport Support | 1-13 |
| 1.3.7 General Aviation..... | 1-13 |
| Airfield | 2-1 |
| 2.1 Introduction | 2-1 |
| 2.2 Existing Facilities and Operations..... | 2-1 |
| 2.2.1 Airfield Geometry..... | 2-1 |
| 2.2.2 Airspace Interactions | 2-2 |
| 2.2.3 Air Traffic Control and Airspace Constraints | 2-6 |
| 2.2.4 Fleet Mix | 2-6 |
| 2.3 Airfield Facility Requirements..... | 2-7 |
| 2.3.1 Runway Length Requirements..... | 2-7 |
| 2.3.2 Airfield Demand vs. Capacity Assessment and Requirements..... | 2-8 |
| 2.3.3 FAA Design Criteria Compliance Review | 2-12 |
| Passenger Terminal..... | 3-1 |
| 3.1 Introduction | 3-1 |
| 3.2 Existing Facilities and Operations..... | 3-1 |
| 3.2.1 Landside Passenger Terminal..... | 3-2 |
| 3.2.2 Airside Concourses and Satellites | 3-5 |
| 3.2.3 Satellite Transit System..... | 3-7 |
| 3.2.4 U.S. Customs and Border Protection Facilities | 3-8 |
| 3.3 Desired Passenger Terminal Characteristics and Planning Assumptions..... | 3-8 |
| 3.3.1 Level of Service | 3-8 |
| 3.3.2 Passenger Activity Assumptions | 3-10 |
| 3.3.3 Airline Check-In and Bag Drop..... | 3-10 |
| 3.3.4 Passenger Security Screening..... | 3-11 |
| 3.3.5 Holdrooms | 3-11 |
| 3.3.6 Gates..... | 3-11 |
| 3.3.7 Concessions | 3-11 |
| 3.3.8 Public Toilets | 3-12 |
| 3.3.9 Baggage Handling Systems | 3-12 |
| 3.3.10 Automated People Mover (APM)..... | 3-12 |
| 3.3.11 U.S. Customs and Border Protection Facilities | 3-13 |

CONTENTS (continued)

| | Page |
|--|------|
| 3.4 Passenger Terminal Facility Requirements | 3-13 |
| 3.4.1 Gates | 3-13 |
| 3.4.2 Airline Check-in and Baggage Drop..... | 3-22 |
| 3.4.3 Passenger Security Screening..... | 3-23 |
| 3.4.4 Baggage Handling Systems | 3-23 |
| 3.4.5 U.S. Customs and Border Protection Facilities | 3-24 |
| Ground Access and Parking..... | 4-1 |
| 4.1 Introduction | 4-1 |
| 4.2 Existing Facilities and Operations..... | 4-1 |
| 4.2.1 Off-Airport Access Roadways | 4-1 |
| 4.2.2 On-Airport Access Roadways..... | 4-2 |
| 4.2.3 Terminal-Area Circulation Roadways..... | 4-7 |
| 4.2.4 Curbside Roadways..... | 4-8 |
| 4.2.5 Commercial Vehicle Facilities..... | 4-10 |
| 4.2.6 Public Parking | 4-12 |
| 4.2.7 Employee Parking..... | 4-17 |
| 4.2.8 Rental Car Facilities | 4-19 |
| 4.2.9 Non-motorized Access..... | 4-19 |
| 4.2.10 Cruise Ship Facilities..... | 4-20 |
| 4.3 Desired Ground Access and Parking Characteristics and Planning Assumptions | 4-20 |
| 4.4 Ground Access and Parking Facility Requirements..... | 4-21 |
| 4.4.1 Off-Airport Access Roadways | 4-21 |
| 4.4.2 On-Airport Access Roadways..... | 4-21 |
| 4.4.3 Terminal-area Circulation Roadways..... | 4-27 |
| 4.4.4 Curbside Roadways..... | 4-30 |
| 4.4.5 Commercial Vehicle Facilities..... | 4-37 |
| 4.4.6 Public Transit Facilities | 4-41 |
| 4.4.7 Public Parking | 4-41 |
| 4.4.8 Employee Parking..... | 4-43 |
| 4.4.9 Rental Car Facilities | 4-44 |
| 4.4.10 Non-motorized Access..... | 4-44 |
| 4.4.11 Long-Term Operations | 4-44 |

CONTENTS (continued)

| | Page |
|--|------|
| Air Cargo..... | 5-1 |
| 5.1 Introduction | 5-1 |
| 5.2 Existing Air Cargo Facilities and Operations | 5-1 |
| 5.3 Desired Air Cargo Campus Characteristics and Planning Assumptions..... | 5-3 |
| 5.3.1 Warehouse Locations..... | 5-3 |
| 5.4 Cargo Activity Forecasts..... | 5-6 |
| 5.5 Cargo Warehouse and Freighter Hardstand Requirements..... | 5-7 |
| 5.5.1 Cargo Warehouse Requirements..... | 5-7 |
| 5.5.2 Freighter Hardstand Requirements | 5-9 |
| 5.5.3 Landside Cargo Facilities Requirements..... | 5-9 |
| Airline Support | 6-1 |
| 6.1 Introduction | 6-1 |
| 6.2 Airline Support Facilities, Operations, and Requirements | 6-1 |
| 6.2.1 Aircraft Maintenance Hangars..... | 6-1 |
| 6.2.2 Flight Kitchens | 6-1 |
| 6.2.3 Ground Handling Services Facilities | 6-1 |
| 6.2.4 Fuel Storage and Distribution Facilities | 6-2 |
| 6.2.5 Office Space | 6-3 |
| Airport Support..... | 7-1 |
| 7.1 Introduction | 7-1 |
| 7.2 Aviation Maintenance Facilities..... | 7-1 |
| 7.3 Aircraft Rescue and Firefighting Facilities | 7-2 |
| 7.4 Aircraft Ground Run-up Enclosure..... | 7-3 |
| 7.5 Centralized Receiving Warehouse | 7-3 |
| 7.6 Trash, Recycling, and Compost..... | 7-3 |
| 7.7 Utilities | 7-4 |
| General Aviation..... | 8-1 |

Appendix A—Approach to Developing Design Day Flight Schedule

Appendix B—Working Paper – Gate Requirement Summary

TABLES

| | | Page |
|------|---|------|
| 1-1 | Aviation Activity Forecasts Seattle-Tacoma International Airport | 1-2 |
| 1-2 | Facility Requirements Summary Seattle-Tacoma International Airport | 1-14 |
| 2-1 | Runway Data..... | 2-4 |
| 2-2 | Taxiway Characteristics..... | 2-5 |
| 2-3 | Existing Modifications to Design Standards | 2-13 |
| 2-4 | Design Aircraft Classifications for Approach Category, Airplane Design Group, and Taxiway Design Group..... | 2-16 |
| 3-1 | Level of Service Standards..... | 3-9 |
| 3-2 | Summary of Major Terminal Facilities Requirements | 3-14 |
| 3-3 | Existing Aircraft Gate Inventory..... | 3-18 |
| 3-4 | Existing Gate and Off-Gate Aircraft Parking Requirements – PAL 1 (2019)..... | 3-19 |
| 3-5 | Existing Gate and Off-Gate Aircraft Parking Requirements – PAL 2 (2024)..... | 3-20 |
| 3-6 | Existing Gate and Off-Gate Aircraft Parking Requirements – PAL 3 (2029)..... | 3-21 |
| 3-7 | Existing Gate and Off-Gate Aircraft Parking Requirements – PAL 4 (2034)..... | 3-22 |
| 4-1 | Existing On-Airport Access Roadway Volumes, Capacities, and Levels of Service..... | 4-6 |
| 4-2 | Terminal-Area Circulation Existing Conditions | 4-8 |
| 4-3 | Curbside Roadway Existing Conditions..... | 4-9 |
| 4-4 | Summary of Existing Commercial Vehicle Facilities..... | 4-11 |
| 4-5 | Estimated Main Garage Occupied Spaces, By Parking Duration, April 2013 | 4-16 |
| 4-6 | Existing Public Parking Facility Demands..... | 4-17 |
| 4-7 | Existing Airport-wide Employee Parking Facilities and Use..... | 4-18 |
| 4-8 | Future On-Airport Access Roadway Volumes and Lanes Required to Achieve Los C or Better (PALS 1 and 2)..... | 4-25 |
| 4-9 | Future On-Airport Access Roadway Volumes and Lanes Required to Achieve Los C or Better (PALS 3 and 4)..... | 4-26 |
| 4-10 | Existing and Future Peak Hour Volumes, Selected Terminal-Area Roadways, One-Terminal Scenario..... | 4-28 |
| 4-11 | Volume/Capacity Ratios and Corresponding Level of Service, Selected Terminal-Area Roadways, One-Terminal Scenario..... | 4-28 |
| 4-12 | Lanes Required to Address Terminal-Area Roadway Deficiencies, One-Terminal Scenario..... | 4-29 |

TABLES (continued)

| | Page |
|---|------|
| 4-13 Terminal-Area Circulation Roadway Requirements..... | 4-30 |
| 4-14 Curbside Utilization Level of Service Ratios..... | 4-31 |
| 4-15 Curbside Roadway Level of Service Ratios | 4-31 |
| 4-16 Curbside Vehicle Dwell Times and Lengths..... | 4-34 |
| 4-17 Curbside Vehicle Classification, Upper Drive..... | 4-34 |
| 4-18 Upper Drive Curbside Volumes | 4-35 |
| 4-19 Lower Drive Curbside Volumes..... | 4-36 |
| 4-20 Curbside Requirements..... | 4-37 |
| 4-21 Commercial Vehicle Loading Times..... | 4-38 |
| 4-22 Commercial Vehicle Pickup Volumes..... | 4-39 |
| 4-23 Commercial Vehicle Loading Area Requirements..... | 4-40 |
| 4-24 Commercial Vehicle Hold Lot Requirements | 4-41 |
| 4-25 Public Parking Facility Requirements..... | 4-42 |
| 4-26 Employee Parking Requirements | 4-43 |
| 5-1 Summary of Air Cargo Warehouse Tenants, Areas, and Utilizations | 5-3 |
| 5-2 Forecast Cargo Activity (metric tons)..... | 5-6 |
| 5-3 Potential Cargo Activity Based on Century Agenda Goal for 2037 (tons)..... | 5-7 |
| 5-4 Long-Term Warehouse Utilization Rates (tons/sq. ft. /yr.)..... | 5-7 |
| 5-5 Cargo Warehouse Requirements for Forecast Cargo Activity (sq. ft.)..... | 5-8 |
| 5-6 Cargo Warehouse Requirements for Century Agenda Cargo Activity (sq. ft.)..... | 5-8 |
| 5-7 Freighter Hardstand Requirements..... | 5-9 |
| 5-8 Air Freight Warehouse Dock Requirements..... | 5-10 |
| 6-1 Projected ADPM Airline Jet Fuel Demand and Gross Storage Required to Provide 3-, 5-, 7-, and 10-Day Reserves | 6-3 |

FIGURES

| | | Page |
|------|--|------|
| 2-1 | Airfield Layout | 2-2 |
| 2-2 | Changes in Fleet Mix: 1998-2013 | 2-6 |
| 2-3 | Runway Departure Length Required for Heavy Aircraft – Standard Day +15° C | 2-8 |
| 2-4 | Annual Demand / Capacity Comparison..... | 2-10 |
| 2-5 | Design Aircraft Dimensions..... | 2-15 |
| 2-6 | Taxiway Intersections Where Fillet Widening is Required to Meet Standards for Boeing 777-300 Turning Movements | 2-18 |
| 2-7 | FAA Airport Diagram Identifying Airport Hot Spots..... | 2-19 |
| 2-8 | High Energy Runway-Taxiway Intersections..... | 2-21 |
| 2-9 | Right Angle Intersections | 2-22 |
| 2-10 | Connector Taxiways with Direct Access to a Runway from an Apron..... | 2-23 |
| 2-11 | Taxiway A Intersection Inconsistent with Three-Node Concept..... | 2-24 |
| 2-12 | Illustrations from Advisory Circular 150/5300-13A of Poor and Proper Design of High-Speed Exits | 2-25 |
| 3-1 | Existing Arrivals Level Floor Plan..... | 3-2 |
| 3-2 | Existing Ticketing Level Floor Plan..... | 3-4 |
| 3-3 | Projected Hourly Flows of Departing Passengers..... | 3-10 |
| 3-4 | Illustration of Aircraft Parking Capability of Existing Gates Assuming Maximum Widebody Aircraft..... | 3-15 |
| 4-1 | Regional Travel Model Airport and Non-Airport Peak Hour Traffic Volumes - 2010..... | 4-3 |
| 4-2 | Regional Travel Model Volume/Capacity Ratios - 2010..... | 4-4 |
| 4-3 | On-Airport Access Roadways | 4-5 |
| 4-4 | Key Terminal-Area Roadways..... | 4-7 |
| 4-5 | Long-Duration Parking Transactions, 2010 – 2013 | 4-13 |
| 4-6 | Average Daily Parking Accumulation in the Main Garage, October 2013 | 4-14 |
| 4-7 | Main Garage Peak Occupancies, 2013..... | 4-15 |
| 4-8 | 2035 Regional Traffic Conditions | 4-23 |
| 4-9 | On-Airport Access Roadways with Future South Access and South Airport Expressway ... | 4-24 |
| 4-10 | Key Terminal-Area Roadways..... | 4-27 |
| 4-11 | Curbside Level of Service Depictions | 4-32 |
| 5-1 | Existing Air Cargo Warehouse Locations..... | 5-2 |
| 5-2 | Recommended Dimensions for Key Cargo Warehouse Site Components..... | 5-6 |
| 7-1 | Location of Existing Maintenance Facilities and Shops | 7-2 |
| 8-1 | General Aviation Facilities | 8-2 |

Introduction and Summary

This chapter summarizes the requirements for major functional areas of the Airport through the 20-year planning period.

1.1 Background and Purpose

This *Technical Memorandum No. 5 – Facility Requirements* is the fifth in a series of memorandums which document the analyses, results, conclusions, and recommendations resulting from the Sustainable Airport Master Plan (SAMP) for Seattle-Tacoma International Airport. This Technical Memorandum summarizes the requirements for facilities and associated land areas to accommodate future aviation demand at the Airport, as presented in *Technical Memorandum No. 4 – Forecasts of Aviation Activity*. The facility requirements analyses and results have been organized according to the following functional areas:

- Airfield
- Passenger terminal
- Ground access and parking
- Air cargo
- Airline support
- Airport support
- General aviation

1.2 Planning Activity Levels

Recognizing the uncertainties associated with long-range aviation activity forecasting, four planning activity levels (PALs) were identified to represent future levels of activity at which key Airport improvements will be necessary. Because, for any number of reasons, activity levels could occur at different periods from those anticipated when the forecasts were prepared, the use of PALs allows for facilities planning that is realistically tied to milestone activity levels as they occur, rather than arbitrary years. PAL 1, PAL 2, PAL 3, and PAL 4, and correspond to the forecasts for 2019, 2024, 2029, and 2034, respectively. The aviation activity forecasts associated with each PAL are summarized in Table 1-1. The base year for the forecasts was 2014; even though this document was finalized in 2017, estimated values shown in Table 1-1 and subsequent tables are shown for the base year.

Table 1-1
Aviation Activity Forecasts
Seattle-Tacoma International Airport

| | Estimated 2014 | PAL 1 2019 | PAL 2 2024 | PAL 3 2029 | PAL 4 2034 |
|-----------------------------|-------------------|---------------|---------------|---------------|---------------|
| Total passengers (millions) | 37.4 | 44.8 | 51.8 | 58.9 | 65.6 |
| Aircraft operations | 340,478 | 398,910 | 448,860 | 497,180 | 540,400 |
| Total cargo (metric tons) | 319,842 | 351,550 | 383,000 | 413,750 | 441,860 |

Source: LeighFisher, September 2015.

1.3 Summary of Requirements

The most significant conclusions from the requirements analyses were:

- Improvements in airfield facilities and airfield and airspace operating strategies will be needed beyond the PAL 3 (2029) planning period to avoid high aircraft delay,
- The number of gates available at the Airport is substantially below the number currently needed. By PAL 3 (2029) 24 additional gates will be required; by PAL 4 (2034) 35 additional gates will be required.
- Significant increases in terminal and landside capacity are needed. The application of newer technologies will yield significant capacity and productivity gains for certain passenger processing functions (e.g., ticketing). However, the existing passenger terminal and roadway system cannot accommodate forecast demand without major expansion and modification. Increased activity will exacerbate existing deficiencies in areas required for basic passenger terminal functions such as general passenger circulation, baggage make up, and baggage claim and basic landside functions such as curbsides and roadways.
- Significant increases in cargo warehouse capacity are needed.

Estimates of facility requirements are summarized in Table 1-2.

1.3.1 Airfield

This section summarizes our assessments of airfield capacity and airfield facility requirements.

1.3.1.1 Airfield Capacity

This section summarizes our assessment of the facilities, operations, and characteristics of the operations that most influence airfield capacity.

Airfield Geometry

Five characteristics of the Airport's airfield can limit airfield capacity:

- **Location of passenger terminal relative to runways.** The location of the terminal to one side of the airfield increases the number of times landing aircraft must taxi across an active runway.
- **Location of runway exits.** The location of certain runway exits may increase the time arriving aircraft remain on the runway, particularly on inboard Runway 16L-34R.
- **Effectiveness of taxiway system.** The *Airport's limited taxiway system causes many interactions between taxiing and airborne aircraft, which result in dependencies between operations on the taxiway system and operations on the runway system.*
- **Proximity of runways to terminal area.** Limited space between Runway 16L-34R and the passenger terminal may limit the taxiway system, limit taxiway capacity, and therefore limit airfield capacity (i.e., the taxiway system may not be able to accept aircraft as quickly as the runways can deliver them).
- **Runway stagger.** The southern thresholds of the Airport's three runways are offset from one another (i.e., they are "staggered"). During certain weather conditions, the air traffic control rules related to this stagger require greater separations between operations than would be case otherwise.

Airspace Interactions

Interactions between operations at the Airport and operations at Boeing Field also can limit airfield capacity.

Air Traffic Control and Airspace Constraints

Several factors related to air traffic control procedures and physical facilities at the Airport reduce airfield capacity.

- **Divergent departures headings.** Departing aircraft are no longer permitted to "fan out" on divergent headings.
- **Noise corridors.** A noise "corridor" exists to both the north and south of the Airport. All departing aircraft must use these corridors.
- **Runway spacing.** The spacing between the Airport's runways requires dependent approaches in poor weather.

Fleet Mix

The size of aircraft using the Airport has increased over the last 15 years. This trend towards larger aircraft has led to increases in required aircraft separation, resulting in decreased capacity.

Weather

Weather conditions—cloud ceiling and visibility—determine which air traffic control rules and procedures can be used at the Airport, which in turn affect airfield capacity. The rules governing operations during poor weather conditions (i.e., conditions of reduced cloud ceiling and visibility) are more restrictive than the rules governing operations during good weather conditions.

1.3.1.2 Airfield Facility Requirements

This section summarizes our assessment of facility requirements related to airfield capacity and compliance with FAA design criteria.

Airfield Facility Requirements Related to Airfield Capacity

The most significant conclusion from the airfield facility requirements analysis was that improvements in airfield facilities and airfield and airspace operating strategies will be needed beyond the PAL 3 (2029) planning period to avoid high aircraft delay.

Airfield Facility Requirements Related to FAA Design Criteria Compliance

It is not an unusual circumstance when some characteristics of airport airfield facilities do not comply with current FAA design criteria (i.e., standards). Similar to building codes, design criteria evolve over time. Non-compliance does not indicate unsafe conditions. We reviewed the current modifications to design standards and assessed the Airport's existing airfield layout, signage, and lighting for compliance with applicable FAA design criteria. As a result, we identified eight compliance issues for which facility improvements and/or further study are required:

- **Separation Between Runway 16L-34R and Taxiway B.** The separation required between the centerline of Runway 16L and the centerline of airplane design group V Taxiway B is 500 feet when airplanes in approach categories C, D, and E are conducting approaches with visibility minimums lower than ½ mile. The existing separation is 400 feet. **Existing Airfield Intersection Geometry.** We identified eight intersections involving Taxiway B that require fillet widening to meet the design standards for a B777-300 aircraft (the design aircraft).
- **Blast Pad Geometry.** The blast pads for Runway 16R-34L are currently too small and require enlarging.
- **Runway Incursion Mitigation and Hot Spot Locations.** Hot Spot (HS) locations are airfield geometry on an airport movement area with a history of potential risk of collision or runway incursion, and where heightened attention by pilots and drivers is necessary. HS-1 has been an area on the airfield where runway incursions have occurred in the past. According to the FAA, aircraft taxiing west on Taxiway Q to the end of Runway 34C via Taxiway Q sometimes enter the Runway 34R safety area without authorization. Additional mitigation measures are needed at this location.

HS 2 is an area on the airfield where aircraft sometimes exit Runway 34C on Taxiway F and proceed past hold position marking for Runway 16L-34R without authorization. The requirement is to identify the preferred alternative for resolving this issue.

- **High-Energy Intersections.** The “high energy” portion of a runway is the middle third, where a pilot can least maneuver to avoid a collision. High energy runway-taxiway intersections are intersections that occur in the high-energy portion of a runway. Runway 16C-34C and Runway 16L-34R each has at least one high-energy runway-taxiway crossing. The requirement is to identify a preferred solution that can be implemented at the appropriate time.
- **Right-angle Intersections.** Right angle intersections provide pilots of taxiing aircraft with increased visibility between taxiways and between taxiways and runways. Acute-angle taxiways should not be used as runway entrance or crossing points. Six such acute-angle taxiway crossings of Runway 16C-34C were identified. These should be replaced with right-angle crossings when taxiway rehabilitation is necessary.
- **Direct Access to Runway From an Apron.** FAA design guidance states “do not design taxiways to lead directly from an apron to a runway without requiring a turn.” We identified two such conditions, one at Taxiway L and one at Taxiway N, where direct access from the apron to Runway 16L-34 is provided. A preferred solution that can be implemented at the appropriate time is required.
- **Three-Node Concept.** The three-node concept is based on reducing complex intersections by limiting a pilot to no more than three choices when entering an intersection. An intersection not adhering to the three-node concept occurs on Taxiway A at its intersection with Taxiways C and D near the Runway 16L threshold. A preferred solution for reconfiguring this intersection as soon as possible is required.
- **High-Speed Exit Placement.** The center two high speed exits from Runway 16C-34C, K and M, are poorly located. A preferred solution for reconfiguring these exits is required.
- **No-Taxi Islands.** To reduce the possibility of runway incursions, all designs for a direct entrance to a runway that use two or more taxiway entrances must separate the entrances with “NO-TAXI islands”. A preferred solution for installing a NO-TAXI island between the Runway 34R threshold and its adjacent entrance and bypass

1.3.2 Passenger Terminal

This section summarizes our assessments of passenger terminal operations and facility requirements.

1.3.2.1 Existing Facilities and Operations

The conclusions from our assessment of the passenger terminal operations are summarized below.

Arrivals level

- The arrivals level facilities do not provide the desired level of service to passengers and the public. This issue will be exacerbated as activity increases.
- The ramps leading to the lower level curbside reduce the amount of usable space on the arrivals level by forcing passenger circulation into the bag claim area. This limits the overall efficiency of the space, limits opportunities to expand, and degrades the level of service provided.
- Escalator cores encroach on the space and provide visual barriers between the bag claim areas.
- The capacity of the baggage claim devices (i.e., the length of the belts, also referred to as presentation length) and the surrounding claim areas is insufficient, resulting in crowding and below standard levels of service.

Ticketing level

- The ticketing level does not consistently provide the desired level of customer service.
- The ability to expand the security screening checkpoints is currently limited by existing functions. Security screening checkpoint queues currently encroach on passenger circulation areas behind the ticket counters to the extent that they severely restrict access to the checkpoints, food, beverages, and concessions.
- Ticketing functions are spread out and arrayed in multiple configurations and not as efficient as possible.
- Ramps from the upper level roadway and escalators from the mezzanine level below encroach on the ticketing level space and force passenger circulation further into the building. This results in underutilized space, the misalignment of passenger functions with passenger flows, and severely restricted passenger circulation paths.

Concourse A

- The existing holdrooms are adequate and could be expanded if necessary.
- The distribution, density and quality of concessions should increase with the addition of international arrival and departure gates.
- The travel distance to and the size of existing toilet facilities appears to be adequate. As the size of aircraft during the peak hour increases there may be times when toilet facilities will become crowded.

Concourse B

- Existing holdrooms are undersized for the existing aircraft mix and passengers often stand in the circulation corridor.

- The concessions on Concourse B are limited in size and locations. Sizes are constrained due to the size of the concourse and locations are limited because of holdroom needs.
- The distance to toilet facilities is acceptable but the number of fixtures available is insufficient.

Concourse C

- The holdroom space appears adequate for the current aircraft accommodated.
- The food and beverage and retail facilities in Concourse C appear to be adequate.
- The locations and sizes of toilets appear to be adequate

Concourse D

- The width of Concourse D is narrow and limits passenger movement.
- The existing holdrooms vary in size. The holdrooms at gates D1-D6 may experience some crowding but do not need to be enlarged. The holdrooms at Gates D6-D10 are spacious and permit holdroom sharing to avoid crowding at a single gate.
- There are few concessions available in Concourse D and their opportunity to expand is limited by the existing space.
- The number and locations of toilets appear adequate for the gates being served

South Satellite

- The holdrooms are currently adequate for the aircraft accommodated. As the number of widebody aircraft accommodated increases, the holdrooms will need to be modified accordingly.
- All concessions are currently located in a central food court and restaurant with some retail at the edges. The concessions space will be modified during the renovation project.
- Existing toilets meet the needs of the gates being served. Adjustments may be appropriate during the planned renovation project.

Satellite Transit System

- While the existing system adequately serves the current concourses, the addition of a significant number of new gates may result in the requirement for system modifications to maintain the current passenger minimum connect time between international and domestic flights (currently 80 minutes).
- The existing system can continue to be utilized to serve all or a part of the existing concourses but another system or extension of the existing STS may ultimately be needed for new gates.

U.S. Customs and Border Protection Facilities

- The U.S. Customs and Border Protection facilities at the Airport, located in the South Satellite and constructed in 1973, have reached capacity. The Port Commission has directed that a new International Arrivals Facility, housing new Customs and Border Protection facilities, will be constructed as quickly as possible.
- In parallel with the SAMP, IAF programming and planning were completed in August 2014. Design of the new International Arrivals Facility is underway.

1.3.2.2 Passenger Terminal Facilities Requirements

This section summarizes the requirements for those terminal functions that will most influence the development of terminal alternatives.

Gates

The number of gates available at the Airport is substantially below the number currently needed. By PAL 3 (2029) 24 additional gates will be required; by PAL 4 (2034) 35 additional gates will be required.

Passenger Processing Facilities

Significant increases in passenger processing capacity are needed. The application of newer technologies will yield significant capacity and productivity gains for certain passenger processing functions (e.g., ticketing). However, the existing passenger terminal cannot accommodate forecast demand without major expansion and modification. Increased activity will exacerbate existing deficiencies in areas required for basic passenger processing functions such as general passenger circulation, baggage make up, and baggage claim.

Baggage Handling Systems

Baggage handling systems (BHS) are complex, expensive, and require considerable space. Given the technical complexities of BHS, the Port has engaged a BHS designer who is responsible for the concepts and systems related to baggage screening, early baggage storage, and a baggage conveyor “backbone” are being planned; collectively, these systems will be incorporated into a project referred to as the Baggage Optimization Project. The planning team has coordinated with the BHS designer. However, final decisions governing the overall BHS design have not been made and will occur during detailed planning and design that will occur following completion of the SAMP. Given the responsibilities of the BHS designer, SAMP BHS planning focused on requirements for outbound makeup areas, inbound claim devices, and domestic baggage claim.

Automated People Mover System

The distance between the new IAF located at Concourse A and new domestic gates (locations to be determined during the alternatives task) may create challenges for passengers connecting from arriving international flights to departing domestic flights. In order to deliver these passengers with a high level of service, the chosen system(s) should be able to provide a minimum connect time of 80 minutes. This high level of connecting service should be achievable across all gates, regardless of their locations. The automated people mover system also should provide high levels of service for

passengers connecting between domestic flights. The objective is to effectively integrate the existing satellite transit system and automated people mover system, if any, to simplify the inter-Airport transportation experience.

U.S. Customs and Border Protection Facilities

The new International Arrivals Facility is being designed to (1) increase passenger processing capacity by more than double to 2,600 passengers per hour, (2) nearly double the number of gates capable of serving international wide-body aircraft (from 12 to 20), (3) more than double Passport Check booths and kiosks (from 30 to 80 booths), (4) increase the size and number of bag claim carousels from four to seven, (5) create a single bag claim process, eliminating the need for international passengers to ride a train to baggage claim, and (6) create direct access to ground transportation.

1.3.3 Ground Access and Parking

This section summarizes our assessments of ground access and parking operations and facility requirements.

1.3.3.1 Existing Facilities and Operations

The conclusions from our assessment of the ground access and parking operations are summarized below.

Off-Airport Roadways

- Off-Airport roads of particular importance for the Airport include the surrounding state and regional highway network (i.e., I-5, I-405, SR 518, and SR 509) as well as local roadways (i.e., SR 99 / International Boulevard, S. 188th St, S. 170th St, and S. 160th St) that provide access to and from the Airport. Although the Port does not control these off-Airport access roadways, and their future requirements are outside the scope of the SAMP, the roads were evaluated by Port staff.
- Between the Airport and I-5, the Airport contributes a significant share of the total traffic during the peak hour. On I-5, SR 509, and International Blvd., however, the Airport contributes a very small share of the total volume. A high share of Airport traffic (87%) enters the Airport from the north via the North Airport Expressway while the remainder (13%) enters from the south via City of SeaTac streets. However, approximately 74% of Airport traffic is generated from areas north of the Airport. This discrepancy reflects that a high share of traffic generated to the south uses I-5 and SR 518 to travel to the Airport and therefore, enters Airport property from the north.
- According to Port staff, even though eastbound SR 518 has available capacity in the afternoon, congestion at the I-5/I-405 interchange causes traffic to back up along SR 518. Other conclusions are that congestion from on-Airport roadways occasionally reaches the SR 518 corridor, creating turbulence on westbound SR 518.

On-Airport Access Roadways

Key access roadways, such as the southbound North Airport Expressway, currently experience congestion due to deficiencies on terminal-area roadways, which cause traffic to back up onto access roadways.

Terminal-Area Circulation Roadways

Two of four key terminal-area roadway segments, the approach to the Lower Drive (which, in addition to curbside traffic, includes all traffic entering the 3rd floor courtesy vehicle lanes and approaching the Main Garage from the north) and the exit from the Upper Drive, currently operate at level-of-service E. Level of service E is the next to lowest level of service defined in the Transportation Research Board's *Highway Capacity Manual*. These conditions result in traffic backing up into upstream facilities, such as the Upper Drive and North Airport Expressway.

Curbside Roadways

Curbside requirements are based on vehicle volumes, dwell times, vehicle lengths, and the assumption that demand is uniformly distributed along the curbside length. In practice, dwell times have traditionally been longer and curbside demand has been concentrated in front of major air carriers (i.e., Alaska Airlines). However, dwell times and distribution along the curb can be addressed in whole or in part through increased curbside enforcement and other operational strategies intended to improve the distribution of demand along the curbside.

Cruise Ship Facilities

In 2017 the cruise ship operation in the North Charter Bus Lot will be permanently displaced by the construction of a holdroom for passengers bused to remote gates. Similarly, cruise ship operations at the South Ground Transportation Lot will be permanently displaced due to construction of the IAF. Short-term alternatives for replacing the lost facilities and operations have been developed by Airport Operations; however, a long a long-term solution is needed.

1.3.3.2 Ground Access and Parking Requirements

Off-Airport Roadways

The future effectiveness of off-Airport roadways is essential to efficient Airport access. However, the Port does not control off-Airport roadways and is not responsible for identifying and satisfying their requirements. Port staff should closely coordinate the Airport's future needs with the regional and national agencies responsible for off-Airport roadways.

Terminal-Area Circulation and Curbside Roadways

Significant increases in on-Airport terminal-area circulation roadway and curbside roadway capacity are needed. The existing roadway system cannot accommodate the forecast demand without major expansion and modification. Increased activity will exacerbate existing deficiencies in areas required for basic landside functions such as roadways and curbsides.

Public Parking

The Main Garage and Doug Fox Lot have sufficient capacity to continue to meet parking demand through PAL 4 (2034). Off-Airport parking facilities, however, will need either to increase capacity or reduce their share of the market.

Rental Car Facilities

By PAL 4 (2034), rental car facilities will need to grow by approximately 15%.

Cruise Ship Facilities

Mid- and long-term solutions for cruise ship facilities at the airport will be developed during advanced planning following completion of the SAMP. The term “advanced planning” is used frequently in this document and broadly refers to planning activities that involve greater detail and specificity than are appropriate during master planning.

1.3.4 Air Cargo

This section summarizes our assessments of air cargo operations and facility requirements.

1.3.4.1 Existing Facilities and Operations

- With the exception of FedEx, warehouses at the Airport do not employ a high level of mechanization or sophisticated cargo storage & handling systems. Instead their operations rely on simple forklifts, dollies, and tugs; at most warehouses, cargo is stored directly on the floor for processing and storage during its short dwell time.
- Current issues at cargo facilities are more attributable to layout-related congestion than to actual capacity deficits. This congestion is exacerbated by activity generated by non-cargo operations, such as the Port’s aviation maintenance facility, flight kitchen, and United Airlines maintenance operations interspersed within the cargo campus.
- The nature of the commercial relationships between the Airport and its cargo tenants constrains the Airport’s ability to impose a strict cargo-oriented policy. Tenants are free to sub-lease Airport property originally designated for cargo to non-cargo users, and the Airport has little ability to control such behavior. Additionally, in contrast with business arrangements at other international airports, Airport staff is not involved in determining or mandating service levels and standards. The result is an assortment of relatively small warehouses, each operating individually as best suits its own interests, and the less than optimum utilization of the relatively large area currently allocated to cargo operations.

1.3.4.2 Air Cargo Requirements

- Air cargo facility requirements were estimated for both the volume of air cargo specified by the Century Agenda as well as the volume of air cargo forecast for PALs 1 through 4. The Century agenda air cargo volume exceeds the forecast air cargo activity by approximately 50%.

- A significant increase in air cargo warehouse capacity is needed. By PAL 4 (2034) we estimate that total cargo warehouse area must increase:
- Approximately 43% over the current warehouse area utilized for air cargo—assuming the forecast air cargo activity.
- Approximately 112% over the current warehouse area utilized for air cargo—assuming the forecast air cargo activity.

A significant increase in freighter aircraft hardstand capacity is needed. By PAL 4 (2034) we estimate that the total number of freighter hard positions must increase by approximately 36%.

1.3.5 Airline Support

Airline support facilities include aircraft maintenance hangars, flight kitchens, ground handling service facilities, fuel storage and distribution facilities, and office space.

Alaska Airlines has two aircraft maintenance hangars located to the south of the South Satellite. Delta Air Lines has a single aircraft maintenance hangar located adjacent and to the east of the Alaska hangars. Neither Alaska Airlines nor Delta Air Lines has stated the requirement for additional aircraft maintenance hangars during the planning period.

The airlines and their service providers are responsible for determining the requirements for the flight kitchens. Locating the flight kitchens on Airport property is a convenience but not a necessity.

The future requirements for ground handling services facilities at the Airport will increase as the volume of passenger and aircraft activity increases. The requirements for such facilities will be determined during the advanced planning after the SAMP is completed.

Jet fuel is delivered to the Airport from multiple refineries in Northern Washington via the Olympic Pipeline. The need for a backup delivery source would involve off-Airport facilities and should be explored in advanced planning. The requirement for the future jet-fuel tank storage capacity depends on how many days of reserve jet-fuel the airlines desire for their operations. For the purposes of the SAMP, we have estimated requirements for a range of reserves (3-, 5-, 7-, and 10-days reserve supply).

As part of the SAMP, the airlines have not stated requirements for additional office space. Nevertheless, it is anticipated that such requirements at the Airport will change as the volume of passenger and aircraft activity increases. We assumed (a) the amount of space available for airline offices will increase in the future as additional passenger terminal and gate facilities are provided, (b) specific needs for office space will be determined following completion of the SAMP, and (c) the Port will continue to reallocate existing office space to meet changing future needs.

1.3.6 Airport Support

Airport support facilities include those related to aviation maintenance, aircraft rescue and firefighting, aircraft ground run-up, concessions distribution, recycling and composting, and utilities.

We anticipate the need to relocate many aviation maintenance facilities and have estimated the appropriate requirements. The most significant—and current—need is to relocate the existing maintenance complex located at cargo 4.

We anticipate that the expansion of the Airport's passenger terminal facilities will require that the existing fire station be demolished and replaced with one or more new facilities. We estimated the requirements accordingly.

A ground run-up enclosure is a three-sided structure used to minimize aircraft noise generated when maintenance personnel test aircraft engines. There is no GRE at the Airport. We estimated the area required to accommodate such a facility.

The Airport's existing utility infrastructure systems (i.e., electrical, mechanical, sanitary sewer, storm water drainage, and industrial waste) and the supporting regional infrastructure (e.g., power, water, and sewerage) are generally adequate to meet current and future needs. The utilities requirements associated with future projects will be determined by the specifics of each project and will be determined either during advanced planning or design.

1.3.7 General Aviation

The site utilized to accommodate itinerant general aviation aircraft (i.e., the site accommodating both the fixed base operator building and itinerant aircraft apron) be retained for use by general aviation; it is adequate to accommodate demand through PAL 4 (2034); no increase in size is recommended. There is no requirement to continue leasing land to the Weyerhaeuser Corporation for its corporate hangar.

Table 1-2
Facility Requirements Summary
Seattle-Tacoma International Airport

| Facility | Existing (2014) | PAL 1 (2019) | PAL 2 (2024) | PAL 3 (2029) | PAL 4 (2034) | Sources |
|--|--|-----------------------------|-----------------|-----------------|-----------------|-----------------------|
| BASIS FOR FACILITY REQUIREMENTS (UNCONSTRAINED FORECASTS OF AVIATION ACTIVITY) | | | | | | |
| Total annual passengers (millions) | 37.4 | 44.8 | 51.8 | 58.9 | 65.6 | LeighFisher, 2015 |
| Air Cargo (metric tons) | | | | | | |
| SAMP forecast | | | | | | LeighFisher, 2015 |
| Air freight | 163,233 | 188,370 | 211,770 | 234,090 | 253,400 | |
| Integrator freight | 105,505 | 110,590 | 116,990 | 123,750 | 130,900 | |
| Air mail | 50,752 | 52,520 | 54,160 | 55,820 | 57,470 | |
| Total | 319,490 | 351,480 | 382,920 | 413,660 | 441,770 | |
| | | | | | | Port Commission, 2012 |
| Century Agenda goal | | | | | | |
| Air freight | 164,444 | 201,895 | 247,784 | 304,325 | 373,631 | |
| Integrator freight | 104,535 | 128,342 | 157,571 | 193,456 | 237,513 | |
| Air mail | 50,863 | 52,520 | 54,160 | 55,820 | 57,470 | |
| Total | 319,842 | 382,757 | 459,515 | 553,601 | 668,614 | |
| Aircraft operations | 340,478 | 398,910 | 448,860 | 497,180 | 540,400 | LeighFisher, 2015 |
| AIRFIELD | | | | | | |
| Number of runways | 3 | 3 | 3 | 3 | 3 | LeighFisher, 2015 |
| Design aircraft | | | | | | LeighFisher, 2015 |
| Aircraft Approach Category (a) | D | D | D | D | D | |
| Airplane Design Group (b) | V | V | V | V | V | |
| Taxiway Design Group (c) | 6 | 6 | 6 | 6 | 6 | |
| Runway length (feet) | | | | | | LeighFisher, 2015 |
| Runway 16L - 34R | 11,901 | Existing length is adequate | | | | |
| Runway 16C - 34C | 9,426 | Existing length is adequate | | | | |
| Runway 16R - 34L | 8,500 | Existing length is adequate | | | | |
| Instrument approach capability | CAT III | CAT III | CAT III | CAT III | CAT III | LeighFisher, 2015 |
| Capacity-related requirements | | | | | | |
| Identify physical and procedural improvements to enhance efficiency, increase capacity, and reduce delay | | X | X | X | X | LeighFisher, 2015 |
| Provide de-ice pads near thresholds of Runway 16L-34R | | | | X | X | Port of Seattle, 2014 |
| Compliance-related requirements | | | | | | |
| Separation between Runway 16R-34L and Taxiway B | No expansion, beyond that already approved, to impede meeting 500 foot standard. | | | | | FAA, 2017 |
| Widen fillets at intersections of Taxiway B with Runway 34R and Taxiways D, E, H, K, M, N, and Q | | | X | | | CH2M Hill, 2017 |
| Enlarge blast pads for Runway 16R-34L | | | X | | | CH2M Hill, 2017 |
| Additional mitigation for Runway Incursion Mitigation locations HS 1 & HS 2 | | X | | | | CH2M Hill, 2017 |
| Eliminate taxiway-runway crossings in high-energy portion of: | | | | | | CH2M Hill, 2017 |
| Runway 16C-34C ; Taxiway J | | | | X | | |
| Runway 16L-34R; Taxiways K, M, N | | | | X | | |
| Eliminate acute-angled intersections between Runway 16L-34R and crossing taxiways F, H, K, M, N, and P | | | | X | X | CH2M Hill, 2017 |
| Modify taxiways providing direct access to runway from apron (Taxiways L and N) | | X | X | | | CH2M Hill, 2017 |
| Install "3-node" concept on Taxiway A near Runway 16L threshold | | X | | | | CH2M Hill, 2017 |

Table 1-2 (continued)
Facility Requirements Summary
Seattle-Tacoma International Airport

| Facility | Existing (2014) | PAL 1 (2019) | PAL 2 (2024) | PAL 3 (2029) | PAL 4 (2034) | Sources |
|--|--------------------|-----------------|-----------------|-----------------|-----------------|-----------------------|
| PASSENGER TERMINAL | | | | | | LeighFisher, 2015 |
| Aircraft gates | | | | | | |
| Domestic gates (d) | | | | | | |
| RJ/TP | 20 | 19 | 21 | 21 | 12 | |
| Jet III | 32 | 47 | 50 | 51 | 63 | |
| Jet IV | 12 | 10 | 10 | 8 | 6 | |
| Jet V | 6 | 1 | 1 | 2 | 3 | |
| Jet VI | -- | -- | -- | -- | -- | |
| Total | 70 | 77 | 82 | 82 | 84 | |
| International gates (d) | | | | | | |
| RJ/TP | 1 | 0 | 0 | 0 | 0 | |
| Jet III | 0 | 0 | 1 | 0 | 2 | |
| Jet IV | 2 | 2 | 2 | 2 | 0 | |
| Jet V | 8 | 16 | 19 | 22 | 27 | |
| Jet VI | 2 | -- | -- | -- | -- | |
| Total | 13 | 18 | 22 | 24 | 29 | |
| Total gates (d) | | | | | | |
| RJ/TP | 21 | 19 | 21 | 21 | 12 | |
| Jet III | 32 | 47 | 51 | 51 | 65 | |
| Jet IV | 14 | 12 | 12 | 10 | 6 | |
| Jet V | 14 | 17 | 20 | 24 | 30 | |
| Jet VI | 2 | -- | -- | -- | -- | |
| Total | 83 | 95 | 104 | 106 | 113 | |
| Off-gate parking positions (e) | | | | | | Port of Seattle, 2014 |
| RJ/TP | | 1 | 2 | 3 | 4 | |
| Jet III | | 20 | 22 | 27 | 30 | |
| Jet IV | | 3 | 4 | 3 | 3 | |
| Jet V | | 4 | 3 | 4 | 7 | |
| Jet VI | | -- | -- | -- | -- | |
| Total | | 28 | 31 | 37 | 44 | |
| Passenger check-in facilities | | | | | | LeighFisher, 2015 |
| Check-in lobby | | | | | | |
| Kiosk no bag check | 40 | 77 | 80 | 84 | 90 | |
| Agent with bag check | 214 | 211 | 219 | 235 | 250 | |
| Garage | 15 | 11 | 11 | 11 | 12 | |
| Curb | 15 | 14 | 15 | 16 | 17 | |
| Passenger security screening checkpoints | | | | | | LeighFisher, 2015 |
| Number of screening lanes | 31 | 34 | 36 | 37 | 41 | |
| Queue length with 10 min wait (pax) | n/a | 992 | 1,050 | 1,079 | 1,196 | |
| Domestic baggage claim | | | | | | Logplan, 2016 |
| Total claim frontage (feet) | 2,700 | 2,982 | 3,441 | 4,136 | 4,453 | |
| Number of claim devices | 16 | 18 | 20 | 22 | 24 | |
| Domestic and international outbound baggage | | | | | | Logplan, 2016 |
| Peak hour bags | 3,564 | 4,748 | 5,911 | 7,444 | 8,135 | |
| Security screening machines | 12 | 9 | 11 | 15 | 16 | |
| Make-up positions (f) | n/a | 490 | 386 | 422 | 464 | |
| Early-bag storage positions | 0 | n/a | 393 | 652 | 715 | |
| International Arrivals Facility | | | | | | Port of Seattle, 2014 |
| Processing capacity (pax per hour) | 1,200 | 1,900 | 1,900 | 2,600 | 2,600 | |

Table 1-2 (continued)
Facility Requirements Summary
Seattle-Tacoma International Airport

| Facility | Existing (2014) | PAL 1 (2019) | PAL 2 (2024) | PAL 3 (2029) | PAL 4 (2034) | Sources |
|--|--------------------|-----------------|-----------------|-----------------|-----------------|-------------------|
| ACCESS AND PARKING | | | | | | |
| On-Airport access roadways (lanes) | | | | | | InterVISTAS, 2016 |
| Ramp from SR 518, westbound | 2 | 2 | 3 | 3 | 3 | |
| Ramp from SR 518, eastbound | 1 | 1 | 1 | 2 | 2 | |
| North Airport Expressway, southbound, prior to return-to-terminal ramp | 3 | 3 | 4 | 4 | 5 | |
| North Airport Expressway, southbound, after return-to-terminal ramp | 3 | 4 | 4 | 5 | 5 | |
| Terminal area entrance | 4 | 4 | 5 | 6 | 6 | |
| Terminal area exit to north | 4 | 4 | 4 | 4 | 5 | |
| North Airport Expressway, northbound, prior to return-to-terminal ramp | 5 | 5 | 5 | 5 | 5 | |
| North Airport Expressway, northbound, after return-to-terminal ramp | 3 | 3 | 3 | 4 | 4 | |
| Ramp to SR 518, eastbound | 2 | 2 | 3 | 3 | 3 | |
| Ramp to SR 518, westbound | 2 | 2 | 2 | 2 | 2 | |
| Return-to-terminal ramp | 2 | 2 | 2 | 2 | 2 | |
| On-ramp from Air Cargo Road | 2 | 2 | 2 | 2 | 2 | |
| Northbound exit to South 170th Street | 1 | 1 | 1 | 1 | 1 | |
| Southbound exit to South 170th Street | 1 | 1 | 1 | 1 | 1 | |
| Air Cargo Road, southbound, north of South 160th Street | 2 | 2 | 2 | 2 | 2 | |
| Air Cargo Road, northbound, north of South 160th Street | 2 | 2 | 2 | 2 | 2 | |
| Air Cargo Road, southbound, north of South 170th Street | 1 | 1 | 1 | 1 | 1 | |
| Air Cargo Road, northbound, north of South 170th Street | 1 | 1 | 1 | 1 | 1 | |
| Air Cargo Road, southbound, south of South 170th Street | 1 | 1 | 1 | 1 | 1 | |
| Air Cargo Road, northbound, south of South 170th Street | 1 | 1 | 1 | 1 | 1 | |
| Interim South Access, northbound | 1 | 1 | 1 | 1 | - | |
| Interim Access, southbound | 1 | 2 | 2 | 2 | - | |
| South Airport Expressway, northbound | -- | -- | -- | -- | 2 | |
| South Airport Expressway, southbound | -- | -- | -- | -- | 2 | |
| Terminal-area circulation roadways (lanes) | | | | | | InterVISTAS, 2016 |
| Approach to Upper Drive | 2 | 2 | 2 | 3 | 3 | |
| Approach to Lower Drive | 2 | 4 | 4 | 5 | 5 | |
| Upper Drive exit | 1 | 2 | 2 | 2 | 2 | |
| Lower Drive exit to northbound | 2 | 2 | 2 | 3 | 3 | |
| Curbside roadways (linear feet) | | | | | | InterVISTAS, 2016 |
| Enplaning curbside (upper drive) | 1,200 | 1,180 | 1,260 | 1,320 | 1,460 | |
| Deplaning curbside (lower drive) | | | | | | |
| Public curb | 1,050 | 1,250 | 1,350 | 1,390 | 1,480 | |
| Rental car shuttles | 360 | 600 | 720 | 780 | 900 | |
| Public transit | 120 | 120 | 120 | 120 | 120 | |
| Total | 1,530 | 1,970 | 2,190 | 2,290 | 2,500 | |
| Curbside roadways (number of lanes) | | | | | | InterVISTAS, 2016 |
| Enplaning curbside (upper drive) | 4 | 4 | 4 | 4 | 5 | |
| Deplaning curbside (lower drive) | 5 | 5 | 5 | 6 | 6 | |
| Commercial vehicle loading areas (spaces) | | | | | | InterVISTAS, 2016 |
| Taxicabs | 13 | 11 | 11 | 12 | 13 | |
| Taxicab feeder queue | 70 | 64 | 68 | 73 | 82 | |
| On-call limousines | 2 | 2 | 2 | 2 | 2 | |
| Pre-arranged limousines | 48 | 10 | 11 | 11 | 12 | |
| Shared-ride vans | 8 | 4 | 4 | 4 | 4 | |
| Courtesy vehicles | 22 (g) | 22 | 22 | 22 | 24 | |
| Airline crew vans | | 2 | 3 | 3 | 3 | |
| Downtown shuttle | | 1 | 1 | 1 | 1 | |
| Airporters | 2 | 2 | 2 | 3 | 3 | |
| Charter buses | 20 | 19 | 21 | 21 | 23 | |

Table 1-2 (continued)
Facility Requirements Summary
Seattle-Tacoma International Airport

| Facility | Existing (2014) | PAL 1 (2019) | PAL 2 (2024) | PAL 3 (2029) | PAL 4 (2034) | Sources |
|---|---|-----------------|-----------------|-----------------|-----------------|---|
| Public parking (spaces) | | | | | | InterVISTAS, 2016 |
| Close-in | 12,800 | 9,260 | 10,440 | 11,590 | 12,740 | |
| Remote | 1,620 | 1,090 | 1,230 | 1,360 | 1,500 | |
| Off-Airport | 18,500 | 20,400 | 23,000 | 25,500 | 28,000 | |
| Total public parking spaces | <u>32,920</u> | <u>30,750</u> | <u>34,670</u> | <u>38,450</u> | <u>42,240</u> | |
| Employee parking | | | | | | Port of Seattle, 2016 |
| Terminal Employees | 4,810 | 4,900 | 5,500 | 6,200 | 6,900 | |
| Cargo & Maintenance Employees | | | | | | |
| Air Cargo Buildings (sf) | 550,000 | 501,000 | 876,000 | 1,320,700 | 1,275,000 | |
| Aircraft Maintenance Buildings (sf) | 346,000 | 346,000 | 346,000 | 324,000 | 324,000 | |
| Remote Employee Parking Stalls (spaces) | 66 | 70 | 70 | 590 | 750 | |
| On-Site Employee Parking Stalls (spaces) | 1,271 | 1,280 | 1,810 | 1,720 | 1,490 | |
| Total Employee Parking Stalls – Port Facilities | <u>4,876</u> | <u>4,970</u> | <u>5,570</u> | <u>6,790</u> | <u>7,650</u> | |
| Rental car facilities (thousand sf) | 1,700 | 1,700 | 1,700 | 1,700 | 1,970 | InterVISTAS, 2016 |
| Cruise ship facilities | Solutions to be determined in advanced planning | | | | | Port of Seattle, 2017 |
| Non-motorized access | Solutions to be determined in advanced planning | | | | | Port of Seattle, 2017 |
| Commercial vehicle hold lot (spaces) | | | | | | InterVISTAS, 2016 |
| Taxicabs | 98 | -- | -- | -- | 190 | |
| Transportation Network Companies | 43 | -- | -- | -- | 80 | |
| Scheduled airporters | 9 | -- | -- | -- | 14 | |
| Charter buses | 18 | -- | -- | -- | 30 | |
| AIR CARGO | | | | | | |
| Warehouse to meet forecast activity (sf) | | | | | | Logplan, 2015 |
| Air freight | n/a | 270,000 | 303,000 | 335,000 | 362,000 | |
| Integrator freight | n/a | 74,000 | 78,000 | 83,000 | 87,000 | |
| Air mail | n/a | 53,000 | 54,000 | 56,000 | 57,000 | |
| Total | <u>n/a</u> | <u>397,000</u> | <u>435,000</u> | <u>474,000</u> | <u>506,000</u> | |
| Warehouse to meet Century Agenda activity (sf) | | | | | | Logplan, 2015 |
| Air freight | n/a | 288,000 | 354,000 | 435,000 | 534,000 | |
| Integrator freight | n/a | 86,000 | 105,000 | 129,000 | 158,000 | |
| Air mail | n/a | 53,000 | 54,000 | 56,000 | 57,000 | |
| Total | <u>n/a</u> | <u>427,000</u> | <u>513,000</u> | <u>620,000</u> | <u>749,000</u> | |
| Freighter hardstands | | | | | | LeighFisher, 2015 |
| International freighters | 4 | 5 | 5 | 6 | 6 | |
| Diverted flights and maintenance | 2 | 2 | 3 | 3 | 3 | |
| Integrator freighters | 6 | 6 | 7 | 8 | 8 | |
| Domestic freighters | 2 | 2 | 2 | 2 | 2 | |
| Total | <u>14</u> | <u>15</u> | <u>17</u> | <u>19</u> | <u>19</u> | |
| AIRLINE SUPPORT | | | | | | |
| Maintenance hangars | 3 | 3 | 3 | 3 | 3 | Alaska Airlines and Delta Air Lines, 2016 |
| Flight kitchens | 3 | 3 | 3 | 3 | 3 | Port of Seattle, 2016 |
| Fuel storage | | | | | | |
| Based on 7-day reserves | | | | | | Corich Group, 2016 |
| Quantity (millions of gallons) | 17 | 18 | 20 | 23 | 25 | |
| Land area (acres) | 11 | 11 | 12 | 14 | 15 | |
| Based on 10-day reserves | | | | | | Corich Group, 2016 |
| Quantity (millions of gallons) | 17 | 26 | 29 | 32 | 35 | |
| Land area (acres) | 11 | 16 | 18 | 20 | 21 | |

Table 1-2 (continued)
Facility Requirements Summary
Seattle-Tacoma International Airport

| Facility | Existing (2014) | PAL 1 (2019) | PAL 2 (2024) | PAL 3 (2029) | PAL 4 (2034) | Sources |
|---|--------------------|---|-----------------|-----------------|-----------------|-----------------------|
| AIRPORT SUPPORT | | | | | | |
| Aviation maintenance (acres) | 5 | 6 | 6 | 6 | 6 | Corich Group, 2016 |
| Airport rescue and fire fighting (acres) | | | | | | |
| East station | 4 | 2 | 2 | 2 | 2 | |
| West station | n/a | 2 | 2 | 2 | 2 | |
| Ground run up enclosure (acres) | n/a | 2 | 2 | 2 | 2 | Port of Seattle, 2016 |
| Centralized receiving warehouse | n/a | To be determined during advanced planning | | | | Port of Seattle, 2017 |
| Centralized trash, recycling, and compost facility | n/a | To be determined during advanced planning | | | | Port of Seattle, 2017 |
| Utilities | n/a | To be determined during advanced planning | | | | |
| GENERAL AVIATION | n/a | Preserve itinerant apron and FBO building | | | | Port of Seattle, 2016 |

- (a) Aircraft approach category D includes aircraft with an approach speed of 141 nautical miles per hour but less than 166 nautical miles per hour.
- (b) Airplane design group V includes aircraft with a wingspan of 171 feet but less than 214 feet or tail height of 60 feet but less than 66 feet.
- (c) Taxiway design groups are based on main gear width and cockpit to main gear distance and are defined in Federal Aviation Administration (FAA) Advisory Circular 150/5300-13A, Airport Design.
- (d) Aircraft gates were classified according to wingspans included in airplane design groups (ADG) defined in FAA Advisory Circular 150/5300-13A, Airport Design.
- RJ/TP refers to regional jets or turboprops in either ADG I or ADG II and with wingspans no greater than 79 feet.
 - Jet III refers to aircraft in ADG III which have wingspans greater than or equal to 79 feet but less than 118 feet.
 - Jet IV refers to aircraft in ADG IV which have wingspans greater than or equal to 118 feet but less than 171 feet.
 - Jet V refers to aircraft in ADG V which have wingspans greater than or equal to 171 feet but less than 214 feet.
 - Jet VI refers to aircraft in ADG VI which have wingspans greater than or equal to 214 feet but less than 262 feet.
- (e) "Off-gate" parking refers to the number of parking positions needed to accommodate remain-overnight (RON) aircraft. The requirements shown assume that all contact gates are fully utilized for RON aircraft.
- (f) Bag make up requirements for PAL 1 and PAL 2 assume the installation of an early bag store system as recommended in the baggage optimization study.
- (g) 22 spaces are shared among courtesy vehicles, airline crew vans, and the downtown shuttle.

Airfield

This chapter describes the requirements for developing the Airport's airfield facilities to accommodate activity forecast through PAL 4 (2034)

2.1 Introduction

Our assessment of the airfield focused primarily on identifying the requirements for physical improvements related to airfield capacity and delay and compliance with FAA design criteria.

The airfield, shown on Figure 2-1, consists of three runways and associated taxiways. Runway data, including key airfield dimensions and navigational aids, are summarized in Table 2-1. Taxiway characteristics are summarized in Table 2-2.

2.2 Existing Facilities and Operations

The airfield, shown on Figure 2-1, consists of three runways and associated taxiways. Runway data, including key airfield dimensions and navigational aids, are summarized in Table 2-1. Taxiway characteristics are summarized in Table 2-2.

This section describes our assessment of the facilities, operations, and characteristics of the operations that most influence airfield capacity. Discussions related to runway use and weather conditions have been intentionally omitted; these are provided in Technical Memorandum No. 6 Alternatives.

2.2.1 Airfield Geometry

The Airport's key physical geometric characteristics that can limit airfield capacity are described below.

- **Location of passenger terminal relative to runways.** The location of the terminal to one side of the airfield increases the number of times landing aircraft must taxi across an active runway. Such runway crossings affect runway and taxiway capacity.
- **Location of runway exits.** The location of certain runway exits may increase the time an arriving aircraft remains on the runway, particularly on inboard Runway 16L-34R. This additional runway occupancy time adversely affects runway capacity.
- **Effectiveness of taxiway system.** The extent to which taxiing aircraft can move between the runways and gates in a manner that minimizes interactions with airborne aircraft. can reduce dependencies between operations on the taxiway system and operations on the runway system.
- **Proximity of runways to terminal area.** Limited space between Runway 16L-34R and the passenger terminal may limit the taxiway system, limit taxiway capacity, and

therefore limit airfield capacity (i.e., the taxiway system may not be able to accept aircraft as quickly as the runways can deliver them).

- **Runway stagger (i.e., extent to which adjacent runway thresholds are offset from one another).** Simultaneous arrivals to one runway and departures from a parallel runway in Instrument Meteorological Conditions (IMC) require at least 2,500-foot spacing between runway centerlines and no adverse stagger (i.e., a stagger where the far runway threshold is used for arrivals). The general rule for airports where the ends of two parallel runways are offset from one another (i.e., “staggered”) is that the assumed centerline-to-centerline separation of the runways must be adjusted because that required spacing also depends on the magnitude and direction of the stagger. Staggered runways fall into two categories: (1) favorable stagger and (2) adverse stagger. The adjustment in the required no-stagger separation of 2,500 feet is 100 feet for every 500 feet of stagger (favorable or adverse). For example, the adverse stagger at the Airport is about 3,300 feet. Therefore, according to this rule, the runway centerlines of Runways 34L and 34R would need to be separated by 2,500 feet plus $100 \times (3,300/500)$, or about 3,160 feet for independent arrival and departure operations on Runways 34L and 34R, respectively.

2.2.2 *Airspace Interactions*

Three interactions that occur between the Airport and Boeing Field (BFI) and reduce the Airport’s airfield capacity are described below.

- **South Flow Instrument Meteorological Conditions (IMC).** There is an interaction between aircraft arriving into the Airport from the north (i.e., south flow) and BFI, that requires protection for missed approaches into BFI – known as Plan Alpha. This situation occurs when cloud ceilings are less than 2,500 feet, and air traffic controllers at BFI cannot see arriving aircraft into the Airport. Weather conditions which cause this interaction occur approximately 14.9% of the time (4.8% of the time during peak operating time of 7 am-9 pm).
- **North Flow IMC.** There is an interaction between aircraft departing from the Airport to the north (i.e., north flow) and arrivals to BFI. Departures from the Airport are assigned an initial heading of 20 degrees, also known as Plan Charlie, and are held on the ground from the time when a BFI arrival is at the final approach fix until landing is assured (one-in, one-out), resulting in a loss of capacity at the Airport. North flow IMC occurs approximately 0.8% of the time.
- **South Flow Visual Meteorological Conditions (VMC).** There is an interaction between arrivals into the Airport and BFI. Typically, a common arrival stream into the Airport stays above arrival stream into BFI. However, if dual approaches to Runway 16R and 16L into the Airport are being conducted, dual arrival streams are used, and additional spacing is required so that aircraft can keep each other in sight.

Figure 2-1
Airfield Layout
Seattle-Tacoma International Airport

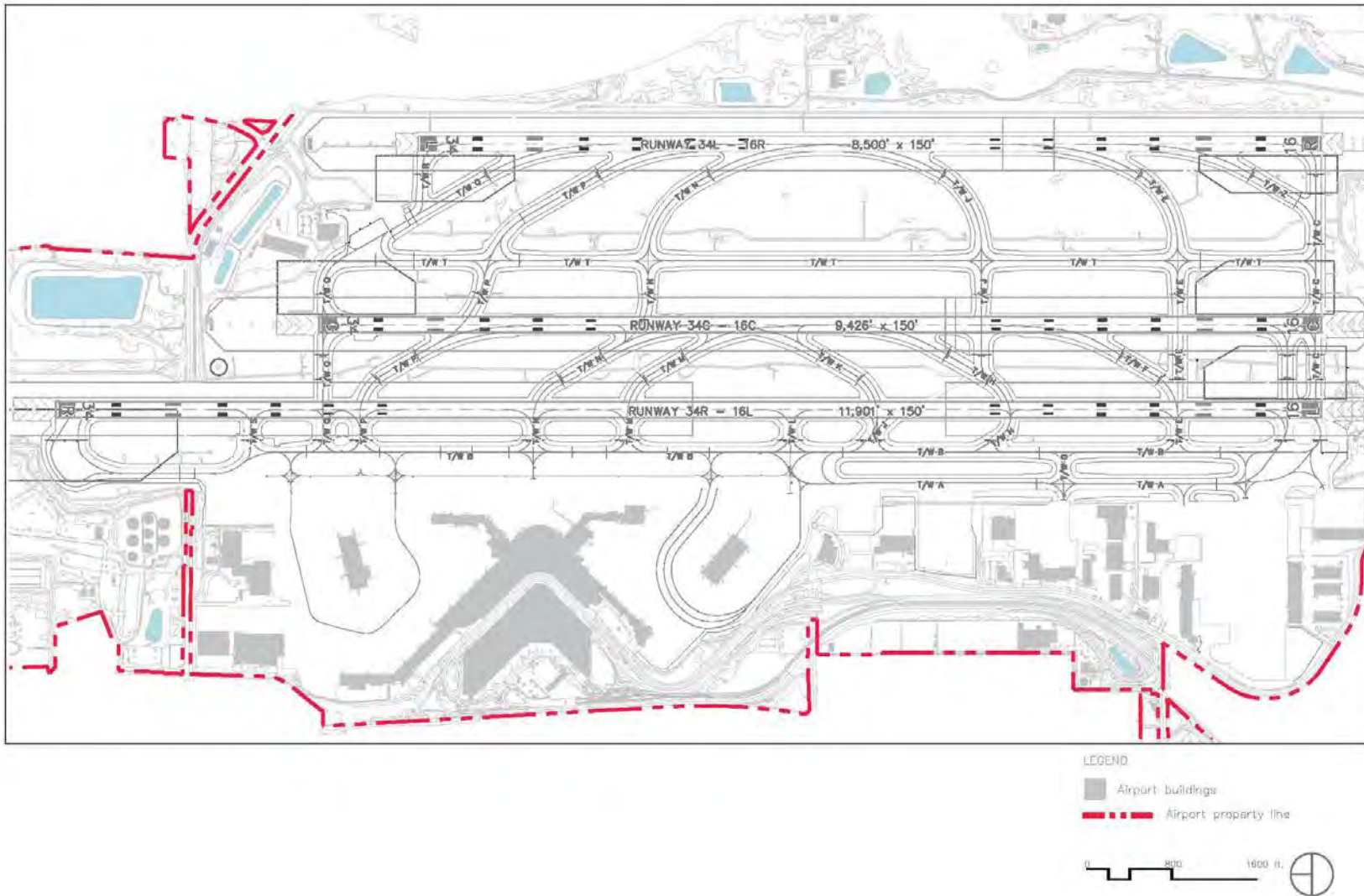

Source: Port "Airport Facilities" drawing (June 2014), updated June 2017.

Table 2-1
Runway Data
Seattle-Tacoma International Airport

| | Runway | | | | | |
|---|------------------------------------|--------------------------|-----------------------------------|--------------------------|------------------------------------|--------------------------|
| | 16L | 34R | 16C | 34C | 16R | 34L |
| Runway length (feet) | 11,901 | 11,901 | 9,426 | 9,426 | 8,500 | 8,500 |
| Runway width (feet) | 150 | 150 | 150 | 150 | 150 | 150 |
| Runway end elevation (feet above MSL) | 433 | 347 | 430 | 363 | 415 | 356 |
| Pavement type/friction | Concrete/grooved | Concrete/grooved | Concrete/grooved | Concrete/grooved | Concrete/grooved | Concrete/grooved |
| Pavement strength (000 pounds) | | | | | | |
| Single gear | 100(S) | 100(S) | 100(S) | 100(S) | 100(S) | 100(S) |
| Dual gear | 230(D) | 230(D) | 250(D) | 200(D) | 216(D) | 216(D) |
| Dual tandem gear | 600(2D) | 600(2D) | 550(2D) | 350(2D) | 448(2D) | 448(2D) |
| Double dual tandem gear | 1400(2D/2D2) | 1400(2D/2D2) | 1128(2D/2D2) | 880(2D/2D2) | 1157(2D/2D2) | 1157(2D/2D2) |
| Runway markings | Precision | Precision | Precision | Precision | Precision | Precision |
| Runway lighting | HIRL | HIRL | HIRL | HIRL | HIRL | HIRL |
| Centerline lights | Yes | Yes | Yes | Yes | Yes | Yes |
| Approach lighting | ALSF-II | MALSR | ALSF-II | MALSR | ALSF-II | MALSR |
| Approach Aids | | | | | | |
| TDZ | TDZ | TDZ | TDZ | LOC | TDZ | LOC |
| LOC | LOC | LOC | LOC | GS | LOC | GS |
| GS | GS | GS | GS | PAPI | GS | PAPI |
| PAPI | PAPI | PAPI | PAPI | PAPI | PAPI | PAPI |
| Instrument approach procedures | ILS (CAT I, II, IIIB) RNAV(GPS) | ILS (CAT I) RNAV(GPS) | ILS (CAT I, I, IIIB) RNAV(GPS) | ILS (CAT I) RNAV(GPS) | ILS (CAT I, II, IIIB) RNAV(GPS) | ILS (CAT I) RNAV(GPS) |
| Minimum approach decision height (feet above MSL) | n.a. | 547 | n.a. | 580 | n.a. | 556 |
| Minimum approach visibility | 300 RVR | 1800 RVR | 300 RVR | 2400 RVR | 300 RVR | 2400 RVR |

Notes:

- ALSF-2 = High-intensity approach light system with centerline sequenced flashers
- CAT = Category
- GPS = Global positioning system
- GS = Glide slope
- HIRL = High-intensity runway light
- ILS = Instrument landing system
- LOC = Localizer
- MALSR = Medium-intensity approach light system with runway alignment indicator lights
- MSL = Mean sea level
- PAPI = Precision approach path indicator
- RNAV = Area navigation
- RVR = Runway visual range

Source: Port of Seattle, 2014. Updated May 2017.

Table 2-2
Taxiway Characteristics
 Seattle-Tacoma International Airport

| Taxiway designation | Type | Location | Width | Length | Exit geometry |
|---------------------|-----------------|---|---------|--------|--------------------------|
| A | Parallel | East side, north of Taxiway L, runs to Taxiway D | 100 | 5,000 | n.a. |
| B | Parallel | East side, from South Apron to North Apron | 100 | 12,700 | n.a. |
| C | Connector | North End, connecting Runways 16L, 16C, 16R | 100 | 2,300 | n.a. |
| D | Connector | North End, Taxiway B to Runway 16L-34R and 16C-34C | 100 | 750 | n.a. |
| E | Exit, Connector | North End, exiting for Runway 34L, connecting Taxiway T, Runway 16C-34C, 16L-34R and Taxiway B | 100 | 2,600 | 30 degrees |
| F | Exit | North End, exiting from Runway 34C, to TW E | 100 | 1,000 | 30 degrees |
| G | Connector | North end, east side, connecting Taxiway A and Taxiway B | 100 | 150 | n.a. |
| H | Exit | North End, exiting from Runway 34C & Runway 16L to Taxiway B | 100 | 1,800 | 30 degrees |
| J | Exit, Connector | North End, exiting for Runway 34L, connecting to Taxiway T, exiting for Runway 16C and 16L to Taxiway B | 100, 75 | 3,750 | 30 degrees 45 degrees |
| K | Exit | North End, exiting from Runway 34C to Taxiway J | 100 | 1,100 | 30 degrees |
| L | Connector | East side, connecting Runway 16L-34R to Taxiway B | 100 | 250 | n.a. |
| M | Exit, Connector | South End, exiting Runway 16C, connecting Taxiway B | 100 | 250 | 30 degrees |
| N | Exit, Connector | South End, exiting Runway 16R, connecting Taxiway T, exiting Runway 16C, connecting Taxiway B | 100 | 3,100 | 45 degrees 30 degrees |
| P | Exit, Connector | South End exiting Runway 16R, connect to Taxiway T, exiting Runway 16C, connecting Taxiway B | 100 | 3,700 | 30 degrees |
| Q | Exit, Connector | South End, exiting Runway 16R, connecting Taxiway T, exiting Runway 16C and Runway 16L connecting Taxiway B | 100 | 3,550 | 30 degrees 90 degrees |
| R | Exit | South End, exiting Runway 16R, connecting Taxiway Q | 100 | 400 | 90 degrees |
| S | Exit | South End, exiting Runway 16L | 100 | 300 | 90 degrees |
| T | Parallel | West side, between Runways 16R-34L and 16C-34C from Taxiway C to Taxiway Q | 100 | 9,300 | n.a. |
| Z | Exit | Exiting Runway 34L, connecting Taxiway C | 100 | 1,200 | 30 degrees |

Notes:

Location Example For T/W C = North end connecting Runways 16L, 16C, 16R
 North End = North of LAT 47d, 27m N
 South End = South of LAT 47d, 27m N

Source: Port of Seattle; Seattle-Tacoma International Airport Layout Plan, 2007.

2.2.3 Air Traffic Control and Airspace Constraints

Several factors related to air traffic control procedures and physical facilities at the Airport reduce airfield capacity:

- **Divergent departures headings.** Departing aircraft are no longer permitted to “fan out” on divergent headings.
- **Noise corridors.** A noise “corridor” exists to both the north and south of the Airport. All departing aircraft must use these corridors.
- **Runway spacing.** The spacing between the Airport’s runways requires dependent approaches in poor weather.

2.2.4 Fleet Mix

As shown on Figure 2-2, the types of aircraft using the Airport have changed greatly over the last 15 years. Specifically, smaller air taxi aircraft (those with 60 seats or less) have been replaced by larger air carrier narrow-body aircraft. In 2000, approximately half of the Airport’s fleet mix consisted of narrow-body aircraft. Today, narrow-body aircraft make up over 90% of the Airport’s fleet mix. This trend towards larger aircraft at the Airport has led to increases in required aircraft separation, resulting in decreased airfield capacity.

Figure 2-2
Changes in Fleet Mix: 1998-2013
Seattle-Tacoma International Airport

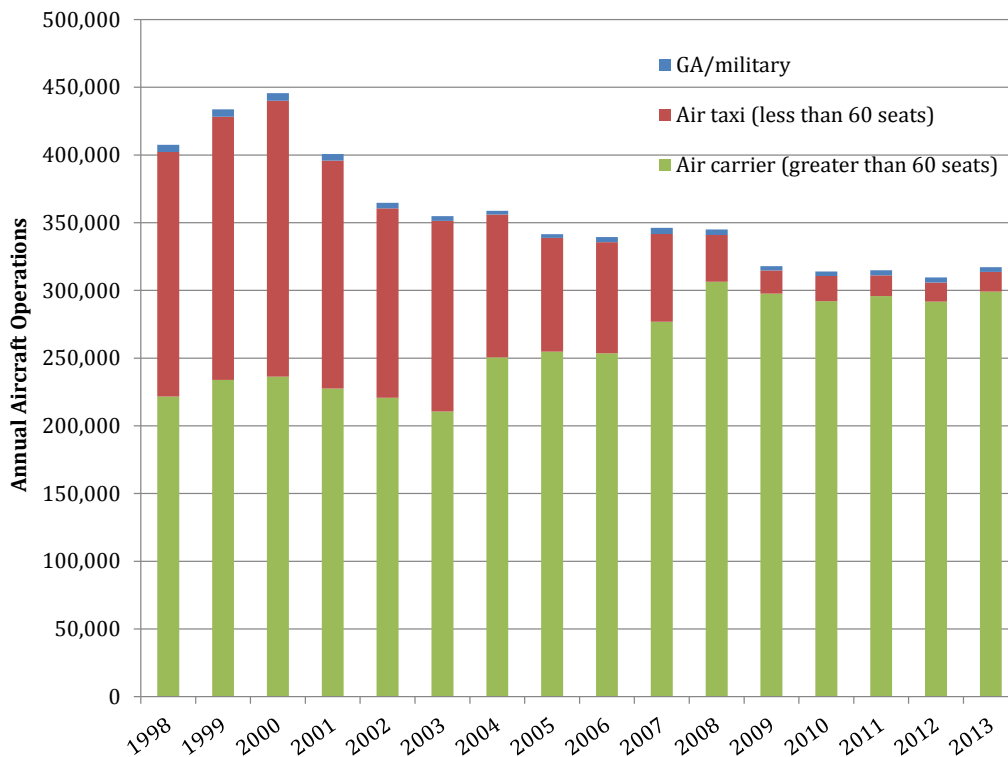

Source: LeighFisher analysis of ATADS data, 2015.

2.3 Airfield Facility Requirements

This section summarizes our assessment of facility requirements related to airfield capacity and compliance with FAA design criteria.

2.3.1 Runway Length Requirements

This section summarizes our assessment of takeoff runway length requirements for heavy aircraft (i.e., aircraft capable of operating at maximum weights in excess of 300,000 pounds). The Airport's runways are known to provide adequate takeoff length for non-heavy aircraft and adequate landing length. We anticipate that during subsequent planning it may be necessary to determine the minimum runway takeoff length required for a wider range of aircraft using airline-specific assumptions related to payload and range (e.g., when conducting detailed planning related to end-around taxiways). Such aircraft performance requirements will be determined at that time, with specific inputs from the airline stakeholders.

The assessment was conducted based on guidance provided in *FAA Advisory Circular 150/5325-4B Runway Length Recommendations for Airport Design*, information from documents titled *Airplane Characteristics for Airport Planning* published by Airbus Industries and the Boeing Company, and the following assumptions:

- Charts used were for standard day temperature + 15 ° C
 - Standard day temperature equals 14.4° C or 58° F
 - Standard day + 15 degrees equals 29.4° C or 85° F
 - The Airport's mean maximum daily temperature during the hottest month is 24° C, or 76° F
- Anticipated aircraft engine types
- Zero runway gradient and zero wind Sean?
- Airport elevation of 415 feet
- Heavy aircraft included in the design day flight schedules for PALs 1 through 4

Figure 2-3 presents the takeoff runway length requirements for the selected aircraft types. The lengths required are represented by bars, which are shaded to indicate the runway length necessary for the aircraft to take off at 80%, 90%, and 100% of maximum fuel and payload (i.e., passengers, baggage, and cargo). Based on the results shown, the only aircraft type studied that cannot takeoff at 100% fuel and payload (or, in the case of the A330-300, nearly 100%) is the A340-500. The longest route anticipated for the A340-500 is from Seattle to Frankfurt, Germany, and the number of operations forecast for that route is relatively small. Therefore, from the standpoint of aircraft performance, we conclude that the lengths of Airport's existing runways are adequate and there is no requirement for additional runway length.

Figure 2-3
Runway Departure Length Required for Heavy Aircraft – Standard Day +15° C
 Seattle-Tacoma International Airport

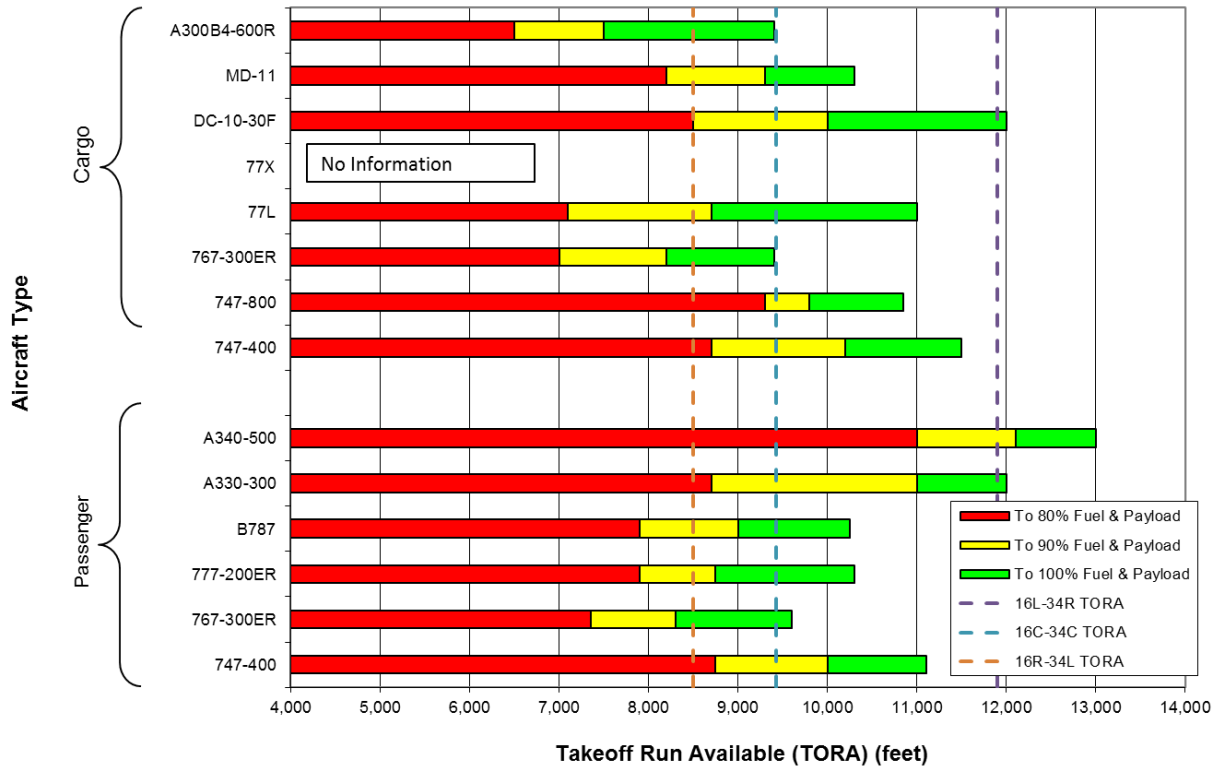

Source: LeighFisher based on FAA guidance and data from aircraft manufacturers, June 2017.

2.3.2 Airfield Demand vs. Capacity Assessment and Requirements

This section provides a high-level summary of the previous capacity analyses as well as LeighFisher’s airfield capacity assessment that was conducted in 2015 in cooperation with the FAA and Port of Seattle. Subsequent to the 2015 assessment, a number of changes occurred, largely as a result of the closure and reopening of the center runway (Runway 16C-34C), that significantly changed existing runway-use procedures and recommended assumptions for estimating the Airport’s existing and future airfield capacity. To reflect these changes, the Port of Seattle decided to undertake an updated analysis (currently underway), which when completed, will supersede the 2015 airfield capacity assessment. The results of the updated airfield capacity assessment will be presented in Technical Memorandum No. 6 Alternatives.

2.3.2.1 Previous Capacity Analyses

In the last 15 years, there have been three airfield capacity analyses of the Airport's three-runway system:

- The 2002 *Airfield Simulation Study* estimated the Airport's capacity to be 587,000 annual operations, based upon the criterion of no more than 20 minutes of average aircraft delay.
- The 2004 *Comprehensive Development Plan* estimated maximum sustainable throughput of the three-runway system to be 110 operations per hour.
- The 2014 FAA *Airport Capacity Profile* for Seattle International Airport included a range of capacity estimates from 112 operations per hour in visual conditions to 76 operations per hour in instrument conditions.

2.3.2.2 Overview of the 2015 Airfield Capacity Assessment

The 2015 airfield capacity assessment included the following:

- Review of previous capacity analyses conducted for the Airport
- Development of an analytical (spreadsheet) assessment of airfield capacity and aircraft delay
- Simulation of airfield operations using the Total Airport and Airspace Modeler

For purposes of assessing airfield capacity, the primary performance metric used was average annual aircraft delay. In this context, delay represents *excess travel times* or *queuing delays* associated with sequencing aircraft arriving to or departing from the Airport.

2.3.2.3 Analytical Capacity Analyses

LeighFisher used industry-standard analytical models and methodologies for estimating hourly and annual airfield capacity and average aircraft delay.

Hourly Capacity

Hourly capacity of the existing airfield was assessed using the Airport Cooperative Research Program (ACRP) Prototype Airfield Capacity Spreadsheet Model, which was based on the industry-standard FAA Airfield Capacity Model (ACM), for Visual Meteorological Conditions, Marginal Visual Meteorological Conditions, and Instrument Meteorological Conditions.

Annual Service Volume

The Annual Service Volume (ASV) of the Airport was calculated. ASV is a reasonable estimate of the annual capacity of an airfield configuration. ASV is not a "hard upper limit"; rather, it has been established in practice that as the level of actual annual aircraft operations approaches ASV, additional increases in aircraft operations result in disproportionate increases in aircraft delays. ASV typically

equates to about 4 to 6 minutes of average annual delay per aircraft movement. ASV takes into account differences in runway utilization, weather conditions, and aircraft fleet mix.

Average Annual Aircraft Delay

Average annual delay was calculated using the FAA Annual Delay Model (ADM), which had been updated in 2011 under a research project sponsored by NASA. Inputs to the ADM included (1) distribution of aircraft operations over months of the year, days of the week, and hours of the day; (2) the percent arrivals over the hours of the day; (3) the percent occurrence of the various runway configurations and weather conditions; and (4) the arrival- and departure-priority hourly airfield capacities for each of the runway-use configurations and weather conditions.

Figure 2-4 depicts the estimated average annual aircraft delay associated with each future annual demand level (i.e., PAL). The delays shown represent the estimated average annual delay levels that would be incurred if future demand levels were to materialize and no procedural improvements or capacity enhancements to the existing airfield were made.

Figure 2-4
Annual Demand / Capacity Comparison
Seattle-Tacoma International Airport

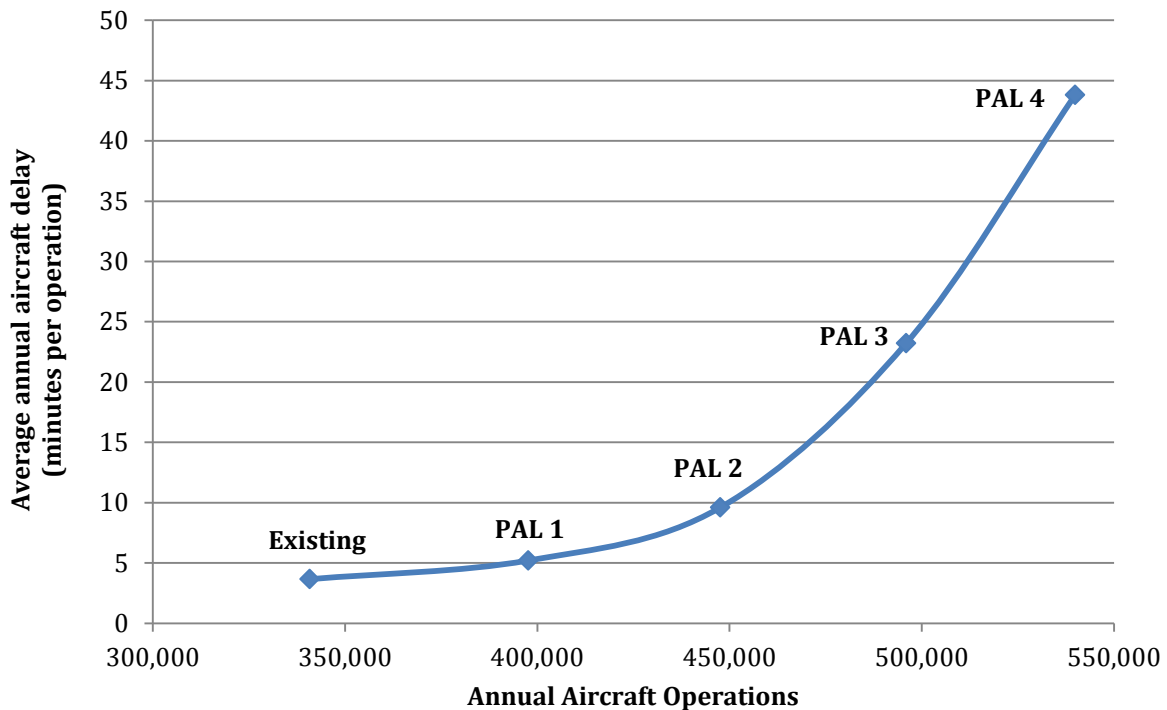

Source: LeighFisher analyses, 2015.

2.3.2.4 Airfield Simulation

Airfield simulation analyses were completed using the Total Airspace and Airport Modeler (TAAM) to evaluate the performance of the existing airfield and to identify the areas on the airfield that limit the capacity and contribute to airfield congestion and delay.

TAAM experiments were run for the existing airfield layout using design day flight schedules for baseline conditions (2014) and forecast levels of activity expected for 2024 (PAL2) and 2029 (PAL3). The assumptions and results from the TAAM simulation analysis are summarized in the January 2016 memorandum titled *Airfield Simulation Modeling Assumptions and Findings*.

The results of the analytical capacity analyses indicated that the existing airfield could likely accommodate forecast activity between PAL2 and PAL3 with average delays of 10 minutes per operation at PAL2 and 23 minutes per operation at PAL3 (refer to Figure 2-3). However, these estimates considered mainly the runway capacity constraints with the implicit representation of the taxiway and airspace constraints represented through assumed aircraft separations and runway-occupancy times.. TAAM explicitly considers how the Airport taxiway system, the apron/gate area, and the airspace will affect airfield capacity and aircraft delay.

Results from the TAAM simulation analysis indicated that (1) PAL2 (2024) demand can be accommodated at an acceptable level of delay without improvements, and (2) PAL3 (2029) demand can be accommodated with average annual aircraft delays of either 16.1 minutes or 20.7 minutes, depending on the method used to assess the relative frequency of visual versus instrument weather conditions.

2.3.2.5 Conclusions and Requirements

Several high-level conclusions from the 2015 assessment are still valid, including the following:

- With no facilities or operational improvements, average annual aircraft delay will likely exceed 20 minutes by PAL 3 (2029). This is an unacceptable level of delay.
- Aircraft delays are attributed not only to the Airport's runway system, but also to the Airport's apron-gate area (or non-movement area), taxiway/hold pad system (or movement area), and airspace restrictions—shortcomings in all these system components contribute to aircraft delay.
- Fundamental changes in airfield facilities and airfield / airspace operating strategies will be needed throughout the planning period to reduce delay to acceptable levels.

The requirement, for both PAL 3 (2029) and PAL 4 (2034), is to identify a range of physical and procedural improvements that will allow the airport's airfield and airspace to be operated more effectively.

At the time this *Technical Memorandum No. 5 – Facility Requirements* was prepared, a number of changes to the airfield operating system, including runway use and the demand profile, have occurred that could affect the aircraft delay estimates resulting from the 2015 airfield capacity assessment. In addition, key assumptions related to operating rules that have a significant impact on capacity and delay (e.g., a waiver for the adverse runway stagger in north flow and the hourly estimated capacities in

the 2014 FAA *Airport Capacity Profiles*) have also changed. Therefore, the planning team and FAA are continuing to assess these and other relevant factors that could influence conclusions regarding the level of average annual delays expected to occur during the planning period.

2.3.3 FAA Design Criteria Compliance Review

This section describes our assessment of the Airport's existing airfield layout, signage, and lighting for compliance with current FAA design criteria.

2.3.3.1 Design Criteria

Applicable design criteria were obtained from FAA Advisory Circulars, Engineering Briefs, and Orders, including the following:

- *FAA Advisory Circular 150/5300-13A, Airport Design*
- *FAA Advisory Circular 150/5340-30H, Design and Installation Details for Aircraft Visual Aids*
- *FAA Engineering Brief 78, Linear Equations for Evaluating the Separation of Airplane Design Groups on Parallel Taxiways and Taxiways to Fixed/Movable Objects*

2.3.3.2 Existing Modifications to Standards

Airfield components which do not meet current FAA airport design standards but have been accepted by the FAA through the issuance of a modification to airport design standards are shown in Table 2-3.

2.3.3.3 Design Aircraft

The design aircraft is defined in *FAA Advisory Circular 150/5300-13A, Airport Design* as having characteristics that determine the application of airport design standards for a specific runway, taxiway, taxilane, apron, or other facility. This aircraft can be a specific aircraft model or a composite of several aircraft using, expected, or intended to use the airport or part of the airport. The Advisory Circular does not specify a minimum threshold level of operations required for an aircraft type to be designated the design aircraft. Instead, the determination of the design aircraft is left to the airport operator's discretion, so long as design is not based on a design aircraft expected to use an airport "infrequently".

In *Technical Memorandum No. 2 – Aviation Activity Forecasts*, LeighFisher identified the design aircraft based on the most demanding aircraft in terms of Main Gear Width (MGW) and distance from Cockpit to Main Gear (CMG) in the forecast fleet mix as the B777-300, which is classified as an Airplane Design Group (ADG) V/ Taxiway Design Group (TDG) 6. For analysis of the existing taxiway geometry and areas of potential fillet widening, the B777-300 was used. For analysis of existing airfield geometry including taxiway separation and potential Object Free Area (OFA) conflicts the ADG V, B747-400 was used because of its wingspan and tail height. Exterior dimensions for the Boeing 777-300 and 747-400 aircraft are illustrated in Figure 2-5.

Table 2-3
Existing Modifications to Design Standards
Seattle-Tacoma International Airport

| Design element | Standard | Existing Condition | Cause of Condition | Mitigation Justifying Modification to Standards | Date Issued |
|--|--|--|--|---|-------------|
| FAA Part 77 - Aircraft Parked at Concourses B&C | No surface penetration | Aircraft tails penetrate 7:1 primary surface | Runway/terminal proximity | None | 1/16/1981 |
| FAA Part 77 - Aircraft Parked at N&S Satellites | No surface penetration | Aircraft tails penetrate 7:1 primary surface | Runway/terminal proximity | None | 1/16/1981 |
| FAR Part 77 Surfaces - Parked A/C at Concourse B, C, N & S Satellites | No Surface Penetration | Vertical tail sections penetrate | Terminal location | None | 1/16/1981 |
| Taxiway A Object Free Area | 160 feet from centerline to fixed or moveable object (ADG V) | 154 feet on east side | Retaining wall along service road | None | 12/21/1987 |
| FAA Part 77 - Aircraft Parked at Concourses B&C | No surface penetration | Light standards penetrate 7:1 primary surface | Runway/terminal proximity | None | 9/13/1990 |
| FAR Pat 77 Surfaces - Light Standards on Concourse B&C | No Surface Penetration | Standards penetrate by 34 feet | Terminal location | None | 9/13/1990 |
| Runway 16L Pavement Crown | On centerline | Offset 25 feet to 50 feet east | Original runway construction | None | 4/15/1992 |
| Surface markings - Taxiway H & J Holdlines | Perpendicular to taxiway centerlines | Parallel to runway centerline | Taxiway geometry | None | 5/20/1992 |
| Surface Markings - Taxiway Holdlines H&J (Old B2&B3) | Perpendicular to TW centerlines | Parallel to runway centerline | Taxiway geometry | None | 5/20/1992 |
| Low Visibility Taxiway Lighting System | 5-foot intervals between clearance bar lights | 10 foot intervals between clearance bar lights | Installed prior to AC publication | None | 10/4/2002 |
| Low Visibility Taxiway Lighting System | Non-standard installation of lights | | Installed for demo project prior to AC publication | None | 10/4/2002 |
| Taxiway Centerline Light Lead Off Lights | No lead off lights above 1200-foot RVR | No edge lights installed, need centerline lights | Lighting system design | None | 2/14/2008 |
| Taxiway Centerline Lights Color Coded Inside Runway Holdlines | Color coding inside runway holdlines and ILS holdlines | Color code only inside Runway holdlines | Taxiway Geometry | None | 2/14/2008 |
| B747-8 Operational Plan – Runway 16L/34R-Taxiway B Separation | 550 feet for ARC D-VI | 400 feet | B747-8 larger wingspans | All B747 must use Taxiway A during low-visibility conditions | 12/2/2008 |
| B747-8 Operational Plan - Taxiway A&B Object Free Area Width | 386 feet for ARC D-VI | 300 feet | B747-8 larger wingspans | Calculate OFA using formula per aircraft instead of entire Group standard | 12/2/2008 |
| B747-8 Operational Plan - Taxiway C&D Wingtip Clearance BTN Runway 16L/34R and 16C/34C | 62 feet wingtip clearance | 54.88 feet | B747-8 larger wingspans | Calculate wingtip clearance using formula per aircraft instead of entire Group standard and limit other aircraft when the B747-8 is on either C or D taxiways | 12/2/2008 |
| B747-8 Operational Plan - Taxiway C&D Wingtip Clearance at North Hold Apron | 62 feet wingtip clearance | 54.88 feet | B747-8 larger wingspans | Calculate OFA using formula per aircraft instead of entire Group standard | 12/2/2008 |
| B747-8 Operational Plan - Taxiway B & Taxilane W Wingtip Clearance | 62 feet wingtip clearance | 42.3 feet | B747-8 larger wingspans | Allowed under approved MOD | 12/2/2008 |
| B747-8 Operational Plan - Taxiway Fillet Dimensions | Group VI | Group V | B747-8 larger wingspans | None | 12/3/2008 |
| Taxiway B Wingtip Clearance to Vehicle Service Road | 193 feet for ARC D-VI | 167 feet | B747-8 larger wingspans | The POS will move a section of the road | 12/4/2008 |
| Taxiway Q OFA at FBO | 386 feet for ARC D-VI | 320 feet | B747-8 larger wingspans | Calculate OFA using formula per aircraft instead of entire Group standard | 12/5/2008 |

Table 2-3 (continued)
Existing Modifications to Design Standards
Seattle-Tacoma International Airport

| Design element | Standard | Existing Condition | Cause of Condition | Mitigation Justifying Modification to Standards | Date Issued |
|--|--|--|--|--|-------------|
| Taxiway A & Retaining Wall/Vehicle Service Road | 62 feet wingtip clearance | 54 feet | B747-8 larger wingspans | Calculate OFA using formula per aircraft instead of entire Group standard | 12/6/2008 |
| Runway Width & Blast Pad Sizes, All Runways | 200-foot Runway with 40-foot shoulders. Blast Pads 280 feet wide by 400 feet long | All runways 150 feet wide. Runway 16L & 16R shoulders are standard 35 feet. Runway 16C shoulders are 25 feet. Blast Pad sizes vary per Runway end. | SEA is an ADV V airport. All runways meet ADV V dimensions. Runway 16L & 16R shoulders meet ADV V dimensions. RUNWAY 16C shoulders were constructed in 1972, under different standards. No clear requirement for standard pad sizes. | Increase Runway 16C shoulders to 35 feet when RUNWAY is reconstructed in 2016 | 8/18/2011 |
| Taxilane W Separation | AC 150/5300-13a | Taxilane W is restricted to aircraft with 125-foot wingspans. | B767-300ER wingspans | Relocate Taxilane W centerline 13 feet to the east and the vehicle service road 17 feet to the east, to allow for the larger wingspan | 12/12/2013 |
| Taxiway B-Taxilane W Separation & Taxilane to Fixed or Movable Object Separation south of Taxiway N | 232 feet and 113 feet plus submittal of a modification of airport design standards | 232 feet & 113 feet | Need to allow B767-300ER with winglets to operate on Taxilane W | Relocate Taxilane W centerline 13 feet east and the vehicle service road 17 feet east | 2/25/2014 |
| Transverse Grades in the RSA (Runway 16C-34C) | 1.5-inch drop from the shoulder edge followed by a 5% drop for 10 feet, followed by a 1.5% to 3% variable grade to RSA and then a 16:1 grade for 107 feet past the RSA | Existing grades adequately drain. | NA | None | 4/25/2014 |
| Runway 16C-34C Pipe for Storm Drains and Culverts | Pipes must be constructed using Concrete, PVC, or HDPE | Use of ductile iron storm drain pipe beneath the runways and taxiways | Port had previous issues with cracks and defects in concrete pipe | None | 1/15/2015 |
| WSDOT Specifications for Gravel Backfill for Pipe Bedding in Unpaved Areas (Runway 16C-34C) | Material backfill material as specified in D-701-3.5 | WSDOT gravel backfill for pipe zone bedding in pipe zone for non-paved areas | It is not economical to use P-153 CLSM in non-paved areas | None | 1/27/2015 |
| Modification of FAA Specifications for Better Quality Control of Concrete Aggregate (Runway 16C-34C) | Provisions in P-501 require testing for delirious material only in the proposed design mix | Test for deleterious substances as part of the mix design, and during concrete production for each lot of concrete. Submit test reports within 21 days of placement. | Issues with pop-outs on Runway 16R-34L | None | 1/28/2015 |
| Longitudinal Profile with Vertical Curve Placement Within the Last 25% of End of Runway 16C-34C | No grade changes are allowed in the first and last quarter of the runway length | Grade of 0.36% and then 0.80% with associated grade break, smoothed by way of a 1,600-foot vertical curve | Extensive reconstruction and grading would be needed | None | 4/22/2015 |
| Runway 16L-34R Separation to Parallel Taxiway B | Approach Reference Code—D-V Runway to Taxiway separation is 500 feet; D-VI Runway to Taxiway separation is 550 feet Departure Reference Code-- Runway to Taxiway separation is 500 feet for unrestricted operations and 400 feet for restricted operations by ADG-VI aircraft | Runway to Taxiway separation is 400 feet north of Taxiway S | Taxiway B cannot be relocated at this time because of impacts to adjacent facilities | Letter of agreement (LOA) with Seattle Airport Traffic Control Tower (ATCT) and Port of Seattle Ramp Tower (SRT), and ATCT standard operational procedures will facilitate control of aircraft movements on Taxiway B and avoid limiting approaches to Runway 16L-34R in any way. LOA will include procedures where ATCT will advise SRT when RVR drops below 2400 and then airlines will request a 30-minute Prior Permission Required (PPR) from the SRT. This will permit the SRT to plan movements to meet requirements and communicate with ATCT. Operational procedures to separate aircraft will be documented in a LOA between the ATCT and SRT. | 12/21/17 |

Source: Port of Seattle, 2017.

Figure 2-5
Design Aircraft Dimensions
Seattle-Tacoma International Airport

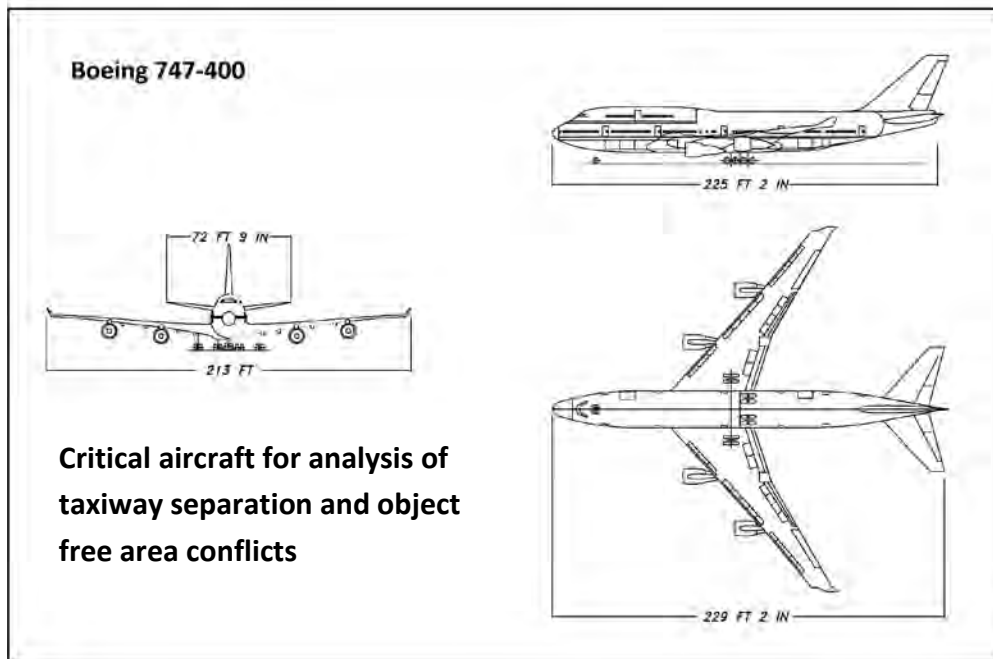
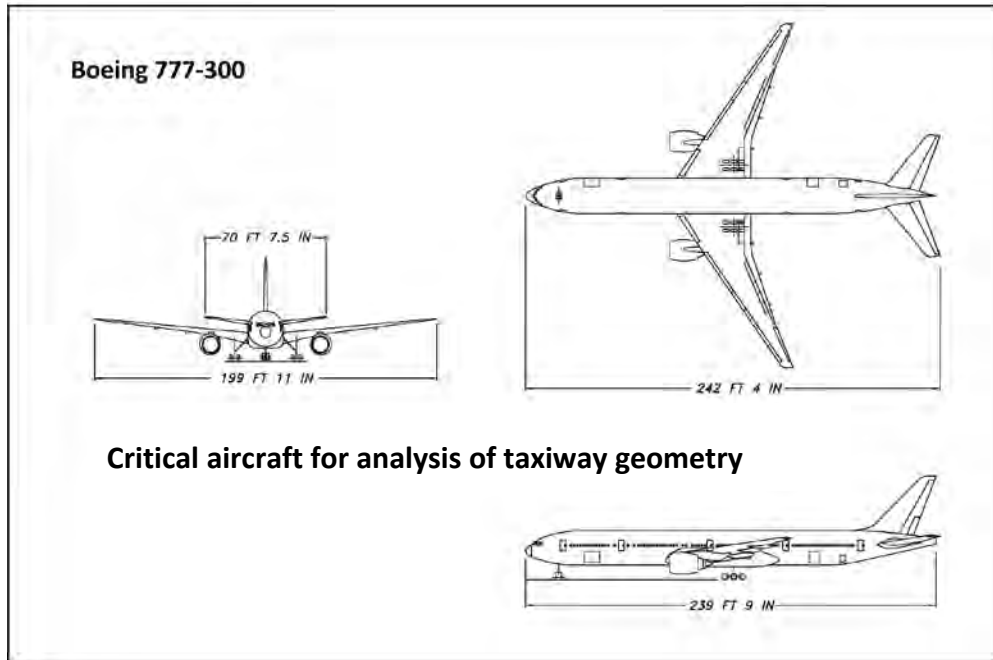

Source: Boeing CAD 3-View Drawings for Airport Planning Purposes.

The design aircraft is classified by three parameters: Aircraft Approach Category (AAC), ADG, and TDG. The AAC categorizes aircraft according to their typical approach speeds and is denoted with letters ranging from “A” to “E,” in order of increasing approach speed. The ADG categorizes aircraft according to wingspan and tail height and is denoted with Roman numerals ranging from “I” to “VI”, in order of increasing wingspan. While ADG classifies aircraft according wingspan and tail height, it does not account for the critical dimensions of the undercarriage. The design of fillets is established using the TDG which classifies aircraft by their maximum gross weight and cockpit-to-main gear distance. The design aircraft classifications for the Airport are shown in Table 2-4.

**Table 2-4
Design Aircraft Classifications for Approach Category, Airplane Design Group, and Taxiway Design Group
Seattle-Tacoma International Airport**

| Parameter | Design aircraft classification |
|----------------------------------|--------------------------------|
| Aircraft Approach Category (AAC) | D |
| Airplane Design Group (ADG) | V |
| Taxiway Design Group (TDG) | 6 |

Source: LeighFisher, September 2015.

2.3.3.4 Results of Compliance Review

The results of the airfield compliance review revealed several issues of non-compliance with design criteria and, therefore, required improvements. These issues and requirements are discussed below.

Compliance Issue #1: Separation Between Runway 16L-34R and Taxiway B

FAA Advisory Circular 150/5300-13A specifies that the separation required between the centerline of Runway 16L-34R and the centerline of Taxiway B is 500 feet. The existing separation is 400 feet. The basis of the requirement is Aircraft Design Group V aircraft related to arrivals in visibility conditions less than 2,400 feet (runway visual range).

The FAA’s expectations are that:

- There will be no further expansion, beyond what has already been approved by the FAA’s Seattle Airports District Office, to impede Runway 16L-34R from meeting the permanent runway-to-taxiway separation standard of 500 feet.
- As opportunities arise to reduce the existing penetrations of the 500 foot standard the Port will take steps to implement the standard separation distance at those locations.
- Until the permanent separation distance standard is met for the full length of the runway and parallel taxiway, the Port will use operational procedures documented by an approved FAA Modification to Standard to meet the separation standard.

- Within three years, the Port shall initiate a study specifically designed to develop a plan for fully meeting this separation standard in the long term.

Compliance Issue #2: Existing Airfield Intersection Geometry for Design Aircraft

The Airport's existing airfield, as at many U.S. airports, was designed and constructed in accordance with Advisory Circular 150/5300-13, before the introduction of today's wide body aircraft. The FAA updated the Advisory Circular to 13A in September 2012, and updated it again with Change 1 in February 2014. The main focus of these updates was reducing the amount of pavement required in taxiway intersections.

We analyzed the airfield's taxiway intersections using computer-aided aircraft modeling. Figure 2-6 identifies those which taxiway intersections will require fillet widening in order to provide the 15' Taxiway Edge Safety Margin (TESM) required for the turning movements of the B777-300 design aircraft. Those intersections with deficient fillets involve the intersection of Taxiway B with the following:

- Runway 34R
- Taxiway D
- Taxiway E
- Taxiway H
- Taxiway K
- Taxiway M
- Taxiway N
- Taxiway Q

The FAA recommends that the Port meet standards when reconstruction projects are required in those areas where intersections with deficient fillets have been identified or undertake a project when there seems to be a problem.

Figure 2-6
Taxiway Intersections Where Fillet Widening is Required to Meet Standards for Boeing 777-300 Turning Movements
Seattle-Tacoma International Airport



Source: CH2M Hill, Engineers, February 2016.

Compliance Issue #3: Runway Blast Pad Geometry

Advisory Circular 150/5300-13A specifies that runway blast pads for Group V aircraft should be 220 feet wide and 400 feet long. As of February 2016, the blast pads for Runway 16R-34L are too small and require enlarging (each of the blast pads is 200 feet wide and 200 feet long). Additional pavement (20' width, 200' length) is required based on AC 150/5300-13A, Change 1, and will be depicted on the updated ALP.

The non-standard blast pad geometry should (1) be corrected with the next FAA funded project for Runway 16R-34L or when there is a significant change in use for this runway, and (2) be documented with an FAA Modification of Standards that records the rationale to leave the blast pads as they currently exist for some period of time.

Compliance Issue #4: Runway Incursion Mitigation & Hot Spot Locations

A Runway Incursion Mitigation (RIM) location is identified by the FAA and defined as a primary contributing factor for runway incursions based on historic runway incursion data. Hot Spot locations are airfield geometry on an airport movement area with a history of potential risk of collision or runway incursion, and where heightened attention by pilots and drivers is necessary. Hot Spot locations can be identified by the Airport or airport users. In some instances RIM locations and Hot Spots may overlap. The FAA has identified three RIM locations at the Airport, two of which overlap the two Airport/user identified Hot Spots. The locations of the Hot Spots, SEA-HS 1 and SEA-HS 2, are shown in Figure 2-7. SEA-HS 1 and SEA-HS 2 are also FAA identified RIM locations.

**Figure 2-7
FAA Airport Diagram Identifying Airport Hot Spots
Seattle-Tacoma International Airport**

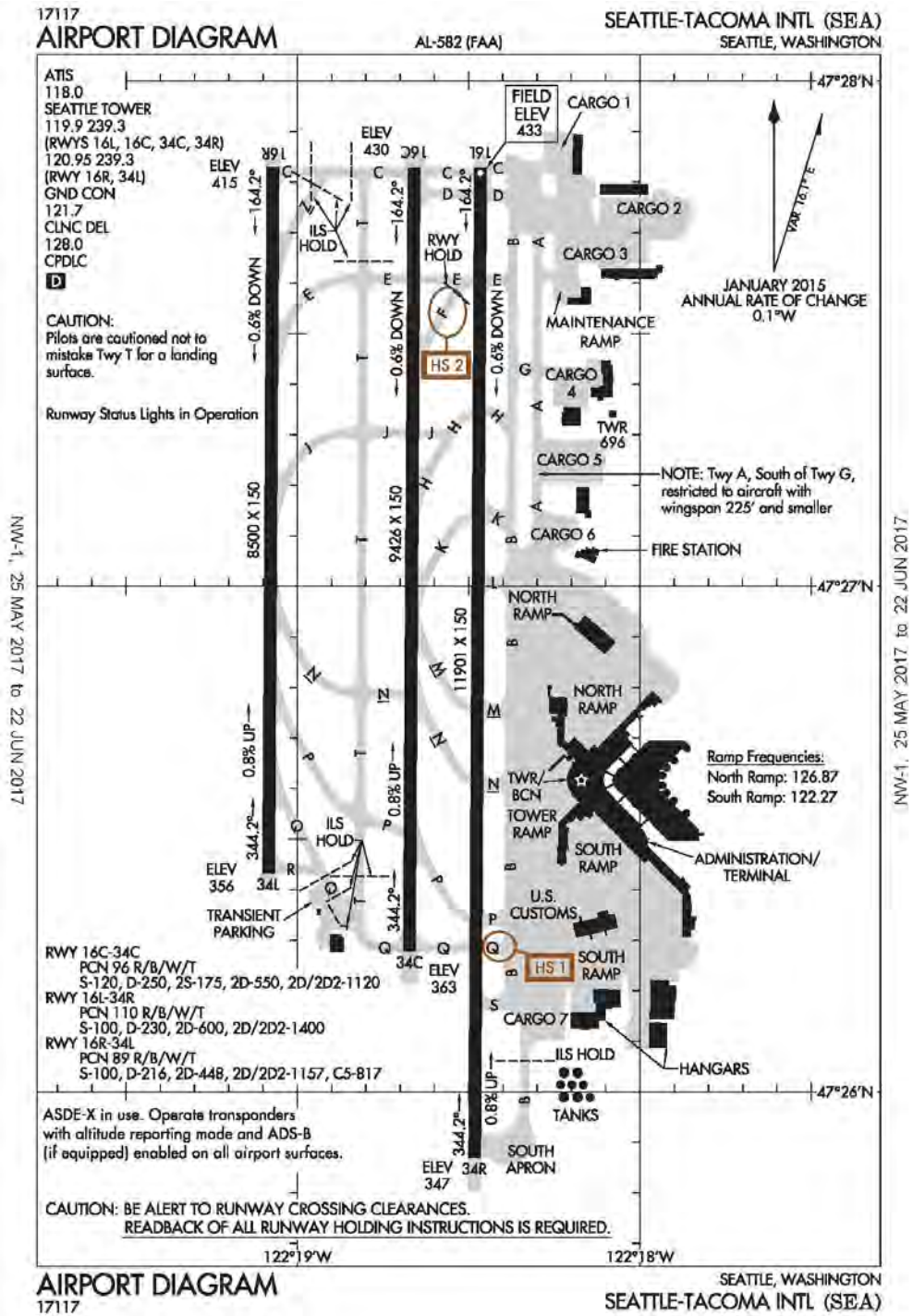

Source: FAA Airport Diagram, June 2017 (Downloaded from Airnav.com in May 2017)

The third RIM location, which is not identified as a Hot Spot, is located at the confluence of Taxiway A, B, C, D in the northeast corner of the movement area.

Among all airfield geometric issues, the FAA assigns RIM locations the highest priority for mitigation. Accordingly, the cost for designing and constructing solutions to RIM locations should be included in the Airport's capital improvement program.

FAA RIM SEA-HS 1

FAA RIM SEA-HS 1 has been an area on the airfield where runway incursions have occurred in the past. According to the FAA, aircraft taxiing to the end of Runway 34C via Taxiway Q sometimes enter the Runway 34R safety area without authorization. The RIM program's records of conversation between pilots and air traffic controllers indicate two issues. The first issue is a propensity for pilots to interpret taxiing instructions to the end of Runway 34C as a direct action from Taxiway B. The second issue is a tendency for aircraft to pass over the hold line slightly when taxiing to the south on Taxiway B and turning west on Taxiway Q. According to the FAA, several matters may be contributing to the pilots either rolling over the Runway 34C hold marking or overshooting it slightly.

- Using the center runway as the primary departure runway is atypical. The practice at most airports is to use the inboard runway as the primary departure runway. Having to cross a runway to reach the primary departure runway is unexpected.
- Pilots are unable to turn onto Taxiway Q from Taxiway B and stop their aircraft with centerlines perpendicular to the hold position marking (insufficient distance between the hold marking and Taxiway centerline)—a position that affords maximum visibility of markings and traffic. This makes it difficult for the pilot to see the marking.
- The width of the taxiway could contribute to pilots having difficulty seeing the hold sign and the existing elevated runway guard lights on the south side of the taxiway hold position.

The requirement is to identify additional mitigation measures and the preferred alternative for improving this area.

FAA RIM SEA-HS 2

FAA RIM / SEA HS 2 is an area on the airfield where aircraft sometimes exit Runway 34C on Taxiway F and proceed past hold position marking for Runway 16L-34R without authorization. Information from the Aviation Safety Reporting System database suggests that pilots do not always see the hold position marking. The reasons for not seeing the marking may be that the pilots are not expecting to exit directly onto another runway or that their exit speed was inconsistent with the exit configuration.

The requirement is to identify the preferred alternative for resolving this issue.

FAA RIM Additional Location

The Third FAA RIM is an area on the airfield where aircraft queue for departures on Runway 16L and 16C. Reports indicate that aircraft may be crossing the Runway 16L hold line as a result of the wide expanse of pavement or angled sweeping nature of Taxiway A. The requirement is to identify the preferred alternative for resolving this issue

Compliance Issue #5: High Energy Intersections

AC 150/5300-13A Section 401.b.5.d discusses the need to avoid “high energy” runway-taxiway intersections. The “high energy” portion of a runway is the middle third, where a pilot can least maneuver to avoid a collision. High energy runway-taxiway intersections are intersections that occur in the high-energy portion of a runway.

As shown on Figure 2-8, Runway 16C-34C and Runway 16L-34R each has at least one high-energy runway-taxiway crossing. Taxiways K, M, and N each cross Runway 16L-34R in the middle third, and Taxiway J is just within the middle third of Runway 16C-34C. The requirement is to follow up with a future analysis outside of this master plan update that will evaluate locations, capacity, and need.

Figure 2-8
High Energy Runway-Taxiway Intersections
Seattle-Tacoma International Airport



Legend

 High-energy portion of runway

Source: CH2M Hill, Engineers, February 2016.

Compliance Issue #6: Right Angle Intersections

Advisory Circular 150/5300-13A Section 401.b.5.e discusses the use of right angle intersections as a method of increasing visibility both between taxiways and between taxiways and runways. Section 401.b.5.e states that “Acute angle runway exits provide for greater efficiency in runway usage, but should not be used as runway entrance or crossing points.”

The acute angle taxiways exiting Runway 16C-34C, shown in Figure 2-9, currently route exiting aircraft directly across Runway 16L-34R due to the lack of a parallel taxiway. While the acute angle taxiways do cross the runway centerline at a 90 degree angle, due to the alignment and wide radius of the taxiways transitioning from the acute angle to the right angle, aircraft approaching the runway hold lines for Runway 16L-34R are aligned on the acute angle and therefore have reduced visibility of the runway they are approaching. Since the length of the angled taxiways is currently used for queuing aircraft and is dependent on runway separation, this condition needs to be examined in the context of the entire airfield. Similar conditions exist where Taxiway P meets Runway 16C-34C on its west side, and where Taxiway C enters Runway 16L. As noted under Compliance Issue #4, Taxiway C will be examined further in this master plan update. Taxiway P west of Runway 16C-34C and the connectors between Runway 16C-34C and Runway 16L-34R require further consideration in future airfield planning outside of this master plan update.

Figure 2-9
Right Angle Intersections
Seattle-Tacoma International Airport

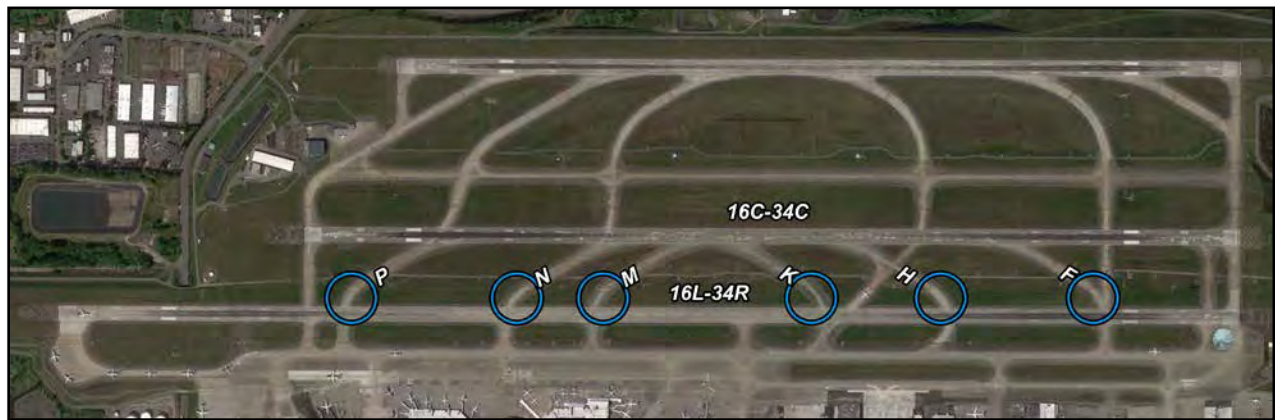

Source: CH2M Hill, Engineers, February 2016.

Compliance Issue #7: Direct Access to Runway from an Apron

Advisory Circular 150/5300-13A Section 401.b.5.g incorporates runway incursion mitigation guidance originally presented in FAA Engineering Brief 75 regarding taxiways which provide direct access to runways from parking aprons. The guidance states “Do not design taxiways to lead directly from an apron to a runway without requiring a turn.”

Runway 16L-34R is served by parallel Taxiway B. Due to the proximity of the terminal to Runway 16L-34R, the portion of Taxiway B from Taxiway K to Taxiway S abuts the terminal apron. The terminal apron is served by Taxilane W, which runs parallel to the abutted portion of Taxiway B described above. Aircraft departing terminal gates taxi to Taxilane W and then turn onto Taxiway B at one of 5 crossover points to taxi to their departure threshold. Two of these crossover points are collocated with Runway 16L-34R exit taxiways, one at Taxiway L and one at Taxiway N, and therefore provide direct access to Runway 16L-34R, as illustrated in Figure 2-10. Taxiway L is going to be relocated in a 2018

capital improvement project. Relocation of the taxiway A-B crossover at Taxiway N will be considered during future pavement reconstruction in this area which is outside of the master planning period ,

Figure 2-10
Connector Taxiways with Direct Access to a Runway from an Apron
Seattle-Tacoma International Airport



Source: CH2M Hill, Engineers, February 2016.

Compliance Issue #8: Three-Node Concept

Advisory Circular 150/5300-13A Section 401.b.3 discusses reducing pilot confusion by utilizing a three-node concept for taxiway intersections. This three-node concept is based on reducing complex intersections by limiting a pilot to no more than three choices when entering an intersection.

Currently, the only intersection not adhering to the three-node concept occurs on Taxiway A at its intersection with Taxiways C and D near the Runway 16L threshold as shown below in Figure 2-11. A preferred solution for reconfiguring this intersection as soon as possible is required

Figure 2-11
Taxiway A Intersection Inconsistent with Three-Node Concept
Seattle-Tacoma International Airport



Source: CH2M Hill, Engineers, February 2016.

Compliance Issue #9: High Speed Exit Placement

Advisory Circular 150/5300-13A Section 409.e discusses the placement of exit taxiways and provides two figures which illustrate the poor design and proper design of high speed exit taxiways, as shown on the Figure 2-12. A preferred solution for reconfiguring these exits will be determined when examining the exits for Compliance Issue #5, High Energy Intersections, in a future analysis to be undertaken outside of this master plan update.

Figure 2-12

Illustrations from Advisory Circular 150/5300-13A of Poor and Proper Design of High-Speed Exits
Seattle-Tacoma International Airport

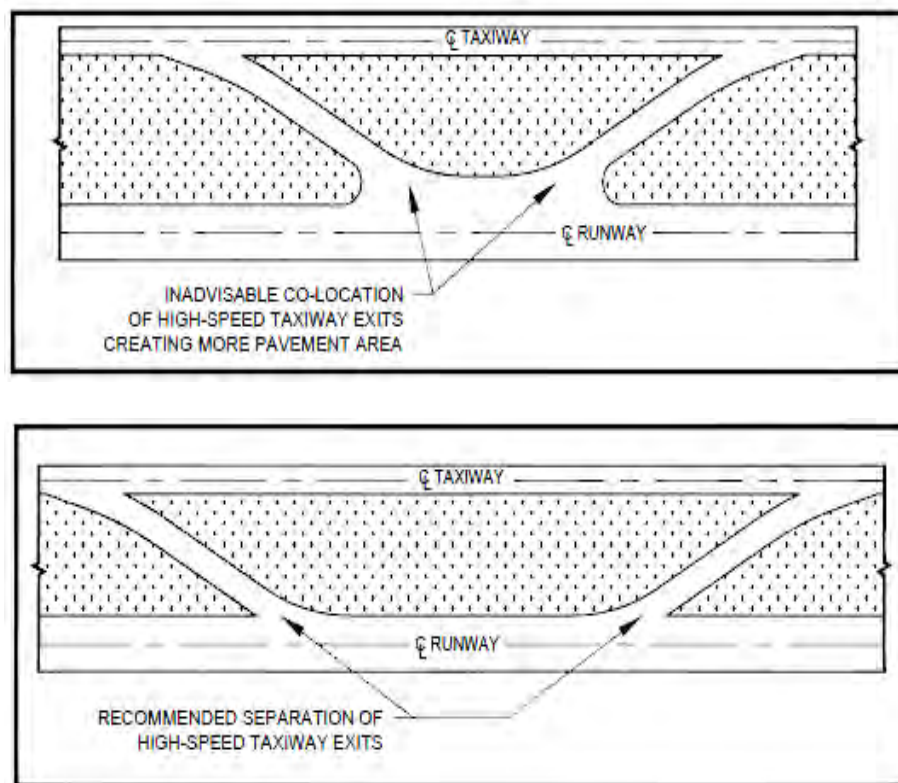

Source: FAA Advisory Circular 150/5300-13A.

Compliance Issue #10: No-Taxi Islands

Runway 34R is accessed by an entrance taxiway and a bypass taxiway from the hold pad near the threshold. Advisory Circular 150/5340-1L states that “Recorded runway incursion data associated with multi-taxi entrance designs to a runway that do not use “NO-TAXI islands” between the adjacent taxiway entrances have experienced a higher rate of runway incursions as compared to entrances with NO-TAXI islands.” To reduce the possibility of runway incursions, all designs for a direct entrance to a runway that use two or more taxiway entrances must use “NO-TAXI islands” that are outlined with the continuous taxiway edge marking. A preferred solution for installing a NO-TAXI island between the Runway 34R threshold and its adjacent entrance and bypass taxiways is required. The solution should be implemented as quickly as possible (resolution of this issue is currently included as part of the Taxiway A/Taxiway B south project which is anticipated to be one of the first projects implemented upon obtaining the necessary environmental approvals). Both the entrance and bypass taxiways should be designated by separate names.

Passenger Terminal

This chapter presents assessments of existing passenger terminal facilities and summarizes the requirements that must be satisfied to accommodate the aviation activity forecast through the 20-year planning period.

3.1 Introduction

Our assessments of passenger terminal facilities and requirements analyses included eleven passenger terminal functions:

- Passenger circulation
- Airline check-in and bag drop
- Passenger security screening
- Holdrooms
- Gates
- Concessions
- Public toilets
- Baggage handling systems
- Domestic bag claim
- Satellite Transit System
- U.S. Customs and Border Protection facilities

3.2 Existing Facilities and Operations

The Airport's passenger facilities consist of a single landside passenger terminal, airside Concourses A through D, the airside South Satellite, and the airside North Satellite. Currently all International arriving passengers are processed through immigration and customs facilities located in the South Satellite. However, a new International Arrivals Facility (IAF), to be located adjacent to Concourse A, is currently being designed and is planned to open by 2020.

3.2.1 Landside Passenger Terminal

The existing passenger terminal consists of four public levels that are connected with a combination of elevators and escalators. The passenger terminal is connected to both the upper and lower curbsides by ramps and to the parking garage by multiple pedestrian bridges. The overall facility is in good condition and has been modified through a variety of Port and tenant improvements.

3.2.1.1 Arrivals Level

The arrivals level of the passenger terminal, shown on Figure 3-1, accommodates all international and domestic arriving passengers and includes seating areas and limited concessions. It is designed to allow passengers to locate and claim their checked baggage from numerous flat-plate and sloped-plate claim devices which are located around the public access portions of the arrivals level and immediately adjacent to the lower level curbside. Elevators and escalators are located in vertical cores throughout the arrivals level. These vertical cores are paired with ramps leading down to the lower level curbside.

The Gina Marie Lindsey Arrivals Hall is on the South end of the arrivals level and is planned to be connected to the new IAF. Vertical transportation cores lead to a mezzanine level, which is connected to the garage by pedestrian bridges and connected to the ticketing level.

Figure 3-1
Existing Arrivals Level Floor Plan
Seattle-Tacoma International Airport

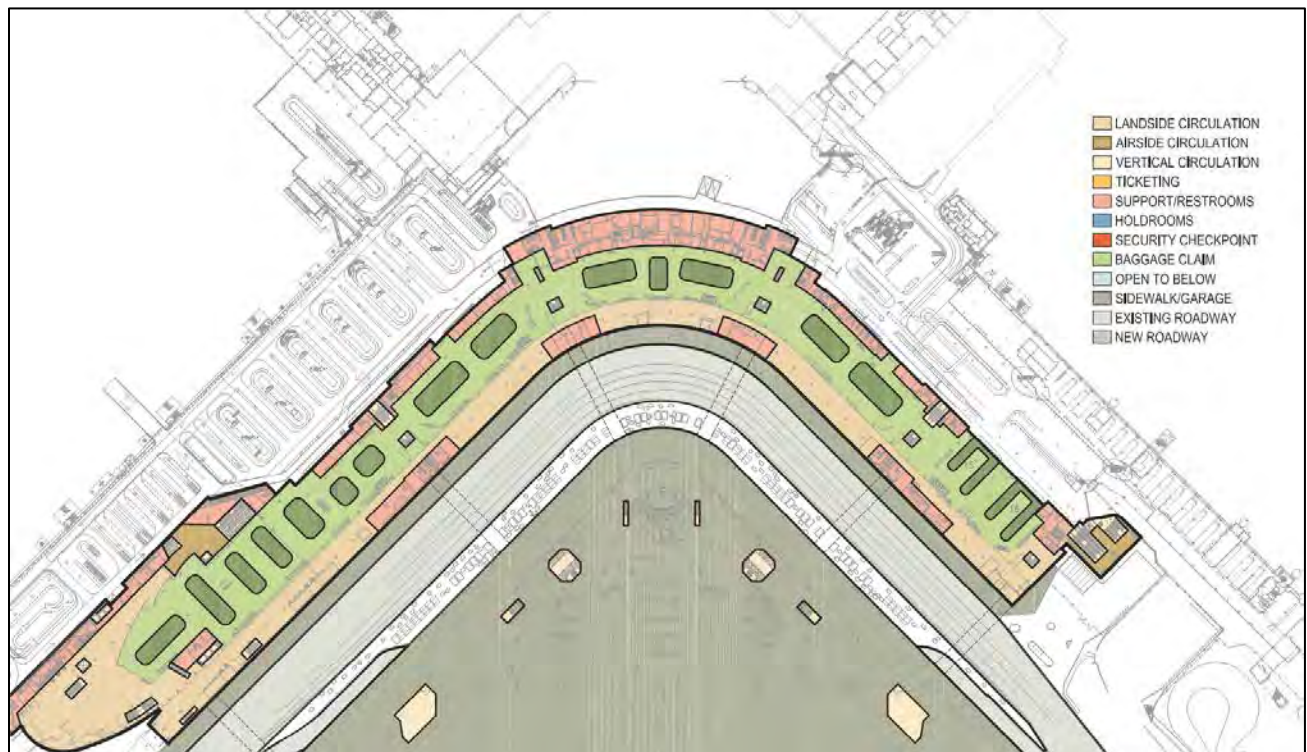

Source: Port of Seattle, 2016.

The conclusions from our assessment of the arrivals level are:

- The arrivals level facilities do not provide the desired level of service to passengers and the public. This issue will be exacerbated as activity increases.
- The ramps leading to the lower level curbside reduce the amount of usable space on the arrivals level by forcing passenger circulation into the bag claim area. This limits the overall efficiency of the space, limits opportunities to expand, and degrades the level of service provided.
- Escalator cores encroach on the space and provide visual barriers between the bag claim areas.
- The capacity of the baggage claim devices (i.e., the length of the belts, also referred to as presentation length) and the surrounding claim areas is insufficient, resulting in crowding and below standard levels of service.

3.2.1.2. Ticketing Level

The ticketing level of the of the passenger terminal, shown on Figure 3-2 accommodates departing passenger check-in and baggage drop functions as well as airline ticketing offices, concessions, and security check points. Ticketing and bag drop counters are arranged in both the traditional in-line counter as well as in the back-to-back ticket island configurations. Ticketing and bag drop counters are located along the glass wall facing the upper level curbside and in the interior of the terminal. Circulation pathways are located both in front of and behind (where appropriate) the ticketing and bag drop counters.

Passenger Security Screening Checkpoints (SSCPs) are provided at four locations on this level within the north-south circulation pathway located behind the ticketing counters. The checkpoint sizes and queueing layouts vary, but are distributed to provide SSCP options closer to gates and existing Satellite Transit System (STS) stations as well the central concession node between concourses B and C. The queuing areas for the SSCP 2 through 4 are so large that they severely restrict the north-south corridor designed to provide access to the SSCP, food, beverages, and concessions.

Vertical transportation cores are positioned to align with bridges connecting the garage to the terminal. These cores, along with ramps up to the upper level curbside force the passenger circulation corridor further into the building. This results in underutilized space in some areas of the ticketing level and a severely restricted north-south circulation corridor in front of the check-in and bag drop counters.

Figure 3-2
Existing Ticketing Level Floor Plan
Seattle-Tacoma International Airport

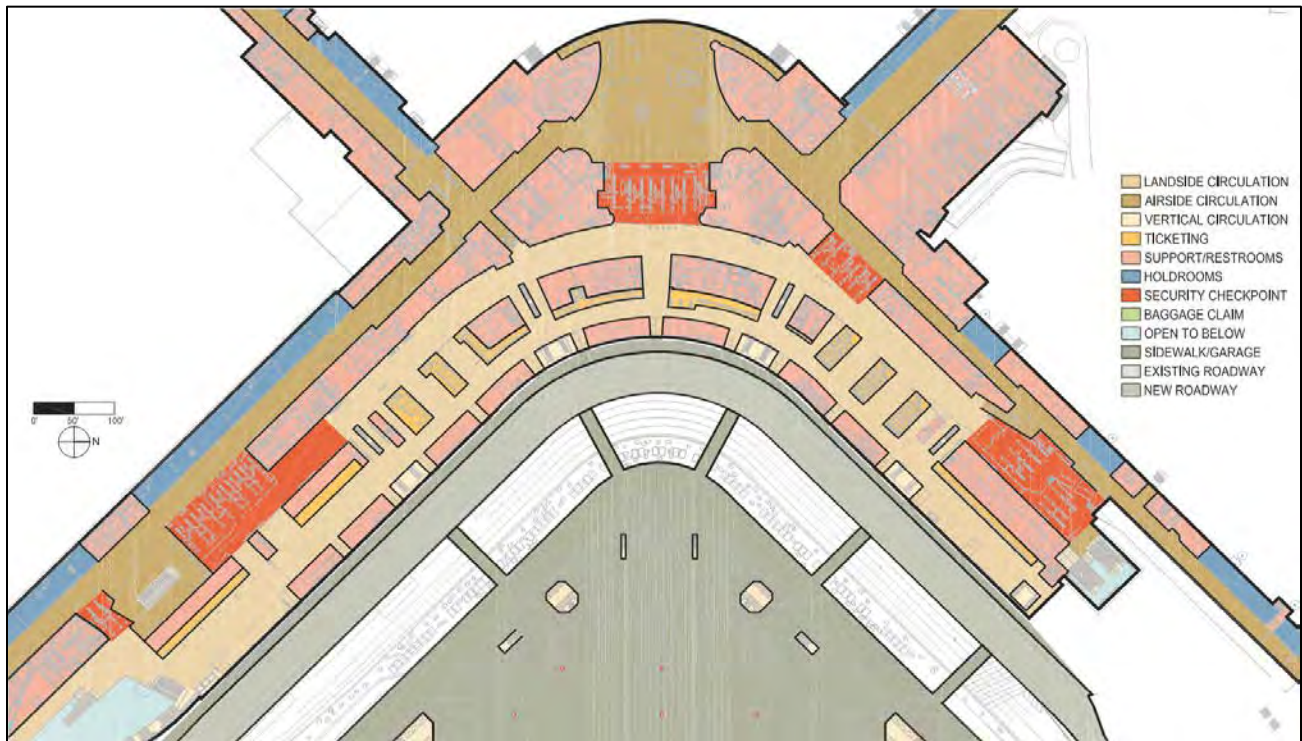

Source: Port of Seattle.

The conclusions from the assessment of the ticketing level are:

- The ticketing level does not consistently provide the desired level of customer service.
- The ability to expand the SSCPs is currently limited by existing functions.
- SSCP queues currently encroach on passenger circulation areas behind the ticket counters to the extent that they severely restrict access to the SSCPs, food, beverages, and concessions.
- Ticketing functions are spread out and arrayed in multiple configurations and not as efficient as possible.
- Ramps from the upper level roadway and escalators from the mezzanine level below encroach on the ticketing level space and force passenger circulation further into the building. This results in underutilized space, the misalignment of passenger functions with passenger flows, and severely restricted passenger circulation paths.

The office mezzanine is located directly over the ticketing area and accommodates a variety of functions. These functions include Port and airline offices, USO facilities, conference rooms and badging

offices. The mezzanine level extends from one end of the ticketing level to the other, ultimately connecting the Port of Seattle airport office tower to the terminal.

3.2.2 Airside Concourses and Satellites

3.2.2.1 Concourse A

Concourse A is the newest of the concourses and serves multiple airlines on 14 gates. Concourse A is single loaded (i.e., it accommodates aircraft gates on only one side), spacious, and designed to incorporate high ceilings and provide abundant natural lighting. Moreover, it provides a high level of customer service.

Concourse A could accommodate the expansion of hold rooms and the provision of additional concessions, if needed. There are plans to connect many of the Concourse A gates with the new IAF, which would allow even greater productivity and flexibility by allowing the gates to be used for either domestic or international arrivals. Access to the STS system is located adjacent to Gate A4.

The conclusions from the assessment of Concourse A are:

- The existing holdrooms are adequate and could be expanded if necessary.
- The distribution, density and quality of concessions should increase with the addition of international arrival and departure gates.
- The travel distance to and the size of existing toilet facilities appears to be adequate. As the size of aircraft during the peak hour increases there may be times when toilet facilities will become crowded.

3.2.2.2 Concourse B

Concourse B is one of the oldest concourses at the Airport. This concourse is double loaded (i.e., it accommodates aircraft gates on both sides) includes two level changes along its length, and accommodates 12 gates. Some holdrooms on Concourse B are undersized for the current fleet mix and are often crowded. Concessions are limited and, due to the narrow concourse width, restrooms are smaller than those on other concourses and passenger movement can feel constrained. Access to the STS system is at the end of the concourse near gate B11.

The conclusions from the assessment of Concourse B are:

- Existing holdrooms are undersized for the existing aircraft mix and passengers often stand in the circulation corridor.
- The concessions on Concourse B are limited in size and locations. Sizes are constrained due to the size of the concourse and locations are limited because of holdroom needs.
- The distance to toilet facilities is acceptable but the number of fixtures available is insufficient.

3.2.2.3 Concourse C

Concourse C, like Concourse B, is one of the oldest concourses in the Airport. Alaska Airlines is the primary air carrier operating out of Concourse C, which has sixteen holdrooms serving 20 aircraft parking positions (6 parking positions are equipped with passenger boarding bridges and 14 positions are ground loaded). The configurations of the hold rooms are purpose-built based on both the apron depth available for aircraft parking and the differences in the requirements between Alaska's mainline aircraft fleet and Alaska's regional aircraft fleet. Thus, the hold rooms for gates C2, C4, C6, C8, and C10 are relatively small, sized for regional aircraft (Alaska's regional aircraft are ground loaded; passengers move between the concourse and aircraft through covered walkways), whereas the hold rooms for gates C9, C11, C15, C17, C18, and C20 are relatively spacious, sized for mainline jets. Access to the STS system is at the end of Concourse C adjacent to gates C11 and C15.

The conclusions from the assessment of Concourse C are:

- The holdroom space appears adequate for the current aircraft accommodated.
- The food and beverage and retail facilities in Concourse C appear to be adequate.
- The locations and sizes of toilets appear to be adequate.

3.2.2.4 Concourse D

Concourse D is a single loaded concourse, is in good condition, and accommodates 10 gates. Five gates are grouped at the north end of the concourse with adjoined hold rooms.

The conclusions from the assessment of Concourse B are:

- The width of Concourse D is narrow and limits passenger movement.
- The existing holdrooms vary in size. The holdrooms at gates D1-D6 may experience some crowding but do not need to be enlarged. The holdrooms at Gates D6-D10 are spacious and permit holdroom sharing to avoid crowding at a single gate.
- There are few concessions available in Concourse D and their opportunity to expand is limited by the existing space.
- The number of toilets is inadequate for the activity being accommodated.

3.2.2.5 South Satellite

There are 14 holdrooms in operation at the South Satellite serving 15 aircraft parking positions. Currently all international arriving passengers are processed through Customs and Border Protection facilities located in the South Satellite, which is wide and has gates located along the exterior and concessions located in the interior. The only connection to the main terminal building is through the existing STS. There is a renovation project planned to expand the South Satellite and update its systems and finishes. This renovation project is being coordinated with a project to design and

construct a new landside IAF, adjacent to Concourse A that will house new Customs and Border Protection facilities. Please refer to Section 3.4.5 for additional information.

The conclusions from the assessment of the South Satellite are:

- The holdrooms are currently adequate for the aircraft accommodated. As the number of widebody aircraft accommodated increases, the holdrooms will need to be modified accordingly.
- All concessions are currently located in a central food court and restaurant with some retail at the edges. The concessions space will be modified during the renovation project.
- Existing toilets meet the needs of the gates being served. Adjustments may be appropriate during the planned renovation project.

3.2.2.6 North Satellite

The NorthSTAR project, currently underway, will result in the expansion and total renovation of the North Satellite by 2020. The North Satellite currently has 14 gates; the NorthSTAR project will result in 20 gates. The only connection to the main terminal building is through the existing STS.

3.2.3 Satellite Transit System

The STS began operating in 1972 and was refurbished approximately 30 years later. The system consists of two loops and a shuttle system serving the existing concourses and satellites. The north loop serves Concourse C, Concourse D, and the North Satellite. The south loop serves Concourse A, Concourse B, and the South Satellite. The shuttle system, which operates between Concourse A and Concourse D, connects the north and south loops.

While the existing system adequately serves the current concourses, the addition of a significant number of new gates may result in the requirement for system modifications to maintain the current passenger minimum connect time (MCT) between international and domestic flights. Currently, MCT is 80 minutes. The existing system can continue to be utilized to serve all or a part of the existing concourses but another system or extension of the existing STS may ultimately be needed for new gates.

There are currently three routes that passengers need to take to transfer between the furthest gates. The locations of the existing station entrances are not intuitive to passengers emerging from security checkpoints. Additionally, the configuration of routes requires some passengers to transfer trains, which can be difficult for first-time passengers. These wayfinding issues increase the chance for passengers to miss their station stops, leading to increased travel time and overall lower perceived level of service. Adding a fourth or fifth system to the existing layout would potentially further compound these wayfinding issues and negatively impact passengers' experience at the Airport. Mitigating wayfinding issues and effectively integrating existing and new systems will be key to providing the desired level of customer service.

3.2.4 U.S. Customs and Border Protection Facilities

The U.S. Customs and Border Protection (CBP) facilities at the Airport, located in the South Satellite and constructed in 1973, have reached capacity. Considerable planning has been completed and the Port Commission has directed that a new International Arrivals Facility (IAF), housing new CBP facilities, will be constructed as quickly as possible.

In parallel with the SAMP, IAF programming and planning were completed in August 2014. In September 2014, the Port's Program Management Group assumed responsibility for advanced planning and design of the IAF.

3.3 Desired Passenger Terminal Characteristics and Planning Assumptions

This section summarizes the desired passenger terminal characteristics that were considered and the assumptions that were made in preparing the passenger terminal requirements. The summary is organized by functional areas of the passenger terminal following a discussion of the level-of-service concept and passenger activity assumptions.

3.3.1 Level of Service

Level of service (LOS) standards used to determine terminal facility requirements for the SAMP are shown in Table 4-1. The LOS standards were adapted from a variety of sources including the Port of Seattle, airlines, consulting firms, Transportation Security Administration (TSA), U.S. Customs and Border Protection (CBP), International Air Transport Association (IATA), Airport Revenue News (ARN) benchmarking, Transportation Research Board (TRB), Highway Capacity Manual, TRB Airport Cooperative Research Program (ACRP) Reports, and the Official Airline Guide (OAG). LOS standards for existing "brownfield" terminals, like the Airport are often different than LOS standards used for planning new "greenfield" terminals due to existing constraints and cost.

Table 3-1
Level of Service Standards
 Seattle-Tacoma International Airport

| Functional Area | LOS Metric | LOS Source |
|-------------------------------|--|---|
| Departure and Arrival Curb | Private vehicles park in 3 lanes maximum with 2 minute dwell max | Port of Seattle |
| | LOS C | TRB Highway Capacity Manual (6th Edition) |
| Check-In | Fit queue in designated area LOS Optimum | IATA Airport Development Reference Manual (10th Edition) |
| | Number of processors | Airlines |
| Security Screening Checkpoint | 10 minute maximum wait in queue | TSA SSCP Staffing (Checkpoint Design Guide) |
| | Fit queue in designated area | Port of Seattle |
| Bag Screening | Calculated number of screening machines = N + 1 | TSA Bag Screening (Planning Guidelines & Design Standards for Checked Bag Inspection Systems) |
| Bag make-up | Number of staged make-up cart positions by aircraft type | IATA Airport Development Reference Manual (10th Edition) |
| Bag claim | <ul style="list-style-type: none"> • Percentage of passengers claiming bags • Linear feet of device • Device utilization time | IATA Airport Development Reference Manual (10th Edition) |
| Concessions | Sales per enplaning passengers sales per square foot | ARN Annual Factbook |
| Restrooms | Number of fixtures | TRB ACRP Report 130 (Guidebook for Airport Terminal Restroom Planning & Design) |
| | <ul style="list-style-type: none"> • Number of fixtures • Distance to restrooms | Washington State Building Code |
| Holdroom | Seated and standing passengers | IATA Airport Development Reference Manual (10th Edition) |
| | Seated and standing passengers | Airlines |
| Minimum Connect Time | 90 minutes for international to domestic transfers | Port of Seattle |
| Gates | <ul style="list-style-type: none"> • Time on gate before towing • buffer time between flights • annual preferential gate allocation • minimum connect time | Port of Seattle |
| FIS | <ul style="list-style-type: none"> • Guidelines for functional area • Automated primary | CBP Airport Technical Design Standards (2016) |
| | <ul style="list-style-type: none"> • Baggage claim • Gates • Minimum connect time | Port of Seattle |

LOS = Level-of-Service

Source: Port of Seattle, 2015.

3.3.2 Passenger Activity Assumptions

Estimates of passenger activity necessary to develop passenger facility requirements for PALs 1 through 4 (2019, 2024, 2029, and 2034, respectively) were obtained from the design day flight schedules. The development of design day flight schedules is described in Appendix 1 of this technical memorandum. The pattern of hourly passenger activity reflected in the design day flight schedules is illustrated in Figure 3-3 for departing passengers.

Figure 3-3
Projected Hourly Flows of Departing Passengers
Seattle-Tacoma International Airport

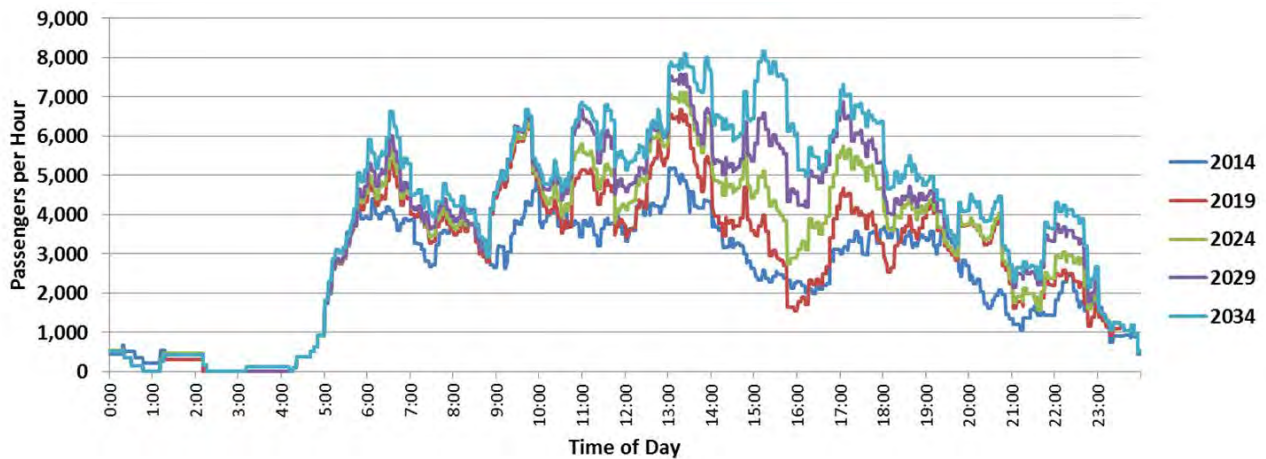

Source: LeighFisher, 2016.

3.3.3 Airline Check-In and Bag Drop

Check-in and bag drop processes are typically sized to accommodate peak hour passenger traffic demand. Each airline will structure its operations and facilities to best suit the needs of its passengers. The Airport currently allows tenant airlines to operate ticketing and bag drop counters in multiple configurations which include in-line ticket counters as well as island counter arrangements. While counters are aligned differently in various sections of the ticketing hall, each airline provides a different service such as kiosk boarding passes; self-tagging of baggage; home tagging of baggage; priority / full service counters and baggage drop areas. Technology is changing the way passengers interact with airline personnel and fulfill their ticketing needs. Often technology allows the airlines to process more people through the same facility footprint without expansion.

Passenger check-in at the Airport also occurs at Common Use Self Service (CUSS) kiosks located both in the garage and in the terminal building. This allows passengers to skip crowded lines and proceed directly to the security screening checkpoint.

Requirements were estimated assuming common use systems, as appropriate, the maximum reasonable benefits from technology, and IATA's Optimum LOS.

3.3.4 Passenger Security Screening

Walk distance from ticketing and bag drop to departure gates and STS stations is an important consideration in planning SSCP locations. Other considerations include (1) the flexibility to shift SSCP lane designations, for example among TSA PreCheck, premium passengers, standard passengers, and Clear, and (2) providing additional crew and employee lanes as peak period passenger demand increases. Centralizing SSCP functions can help increase workforce productivity and flexibility in assigning screening lanes.

Requirements were estimated assuming the maximum reasonable benefits from technology and IATA's Optimum LOS.

3.3.5 Holdrooms

Gate holdrooms are typically sized to accommodate the largest aircraft planned for individual gates and deplaning and boarding functions. Holdrooms should be planned with the flexibility to (1) accommodate variations among the airlines related to passenger processing and holdroom configuration, (2) permit holdroom sharing among gates, and (3) accommodate the blending of holdroom space with concessions space.

Our assessment of existing holdroom sizes were summarized, by concourse and satellite, in Section 3.2.2. Given the Port's priorities for SAMP and its current plans that will result in significant changes and improvements to holdrooms (i.e., NorthSTAR, which will result in a virtually all-new North Satellite and the plan to renovate the South Satellite), we did not estimate requirements for existing hold rooms. Instead, we focused on requirements for new holdrooms associated with new gates. The approach used to ensure the adequacy of new holdrooms was to ensure appropriate widths for all new concourses associated with new holdrooms. This concept is further explained in Technical Memorandum No. 6 – Alternatives.

3.3.6 Gates

Given the severe shortage of land at the Airport, the driving principle in gate planning was to plan gates to ensure maximum flexibility and the maximum potential for high utilization and productivity. Thus, (1) aircraft gates will be planned with the flexibility to accommodate a range of aircraft, consistent with the length and depth of the aircraft apron and the requirements of the airlines using the gates, and (2) gates will be shared among airlines, where possible.

3.3.7 Concessions

Concessions are important Airport revenue generators as well as key factors in assuring customer satisfaction. The Port has both a comprehensive program and a specialty consultant to ensure the continued delivery of high-quality concessions. The approach taken during SAMP planning was to (1) assume the Port and its specialty consultant are continuously reviewing concessions requirements for existing space, and (2) ensure the new facilities planned as part of the SAMP allow space that is appropriate for concessions given the Port's objectives. The allocation of that space retail, food and

beverage concessionaires will occur during advanced planning and design, following the completion of the SAMP.

3.3.8 Public Toilets

Public toilets should be placed in locations that not only satisfy code requirements, but also the Port Commission's level of service objectives. The approach taken in developing the SAMP was to identify existing deficiencies, and plan new spaces with sufficient areas to satisfy those requirements and meet those objectives. The allocation of the planned space and design of the facilities will occur during advanced planning and design, following the completion of the SAMP.

3.3.9 Baggage Handling Systems

Baggage handling systems (BHS) are complex, expensive, and require considerable space. Given the technical complexities of BHS, the Port has engaged a BHS designer who is responsible for the concepts and systems related to baggage screening, early baggage storage, and a baggage conveyor "backbone" are being planned; collectively, these systems will be incorporated into a project referred to as the Baggage Optimization Project. The planning team has coordinated with the BHS designer. However, final decisions governing the overall BHS design have not been made and will occur during detailed planning and design that will occur following completion of the SAMP.

The concepts governing the BHS design are associated with the processing of outbound and inbound baggage. Outbound baggage enters the system at a bag drop facility from which it is transported, in sequence, to one of four locations: (1) baggage security screening, (2) early baggage storage (if provided), (3) outbound baggage make-up where baggage is sorted and placed into containers or carts, and (4) departing aircraft. Upon removal from arriving aircraft, inbound baggage is transported, typically by tug and cart, to inbound baggage belts (where the baggage is unloaded onto inbound baggage systems, and then to claim devices where baggage is claimed by arriving passengers.

Given the responsibilities of the BHS designer, SAMP BHS planning focused on requirements for outbound makeup areas, inbound claim devices, and domestic baggage claim.

3.3.10 Automated People Mover (APM)

APMs have been used in airports for over forty years to connect passengers to airport activity centers, such as the terminals and concourses, transit, remote parking, and rental car facilities. The use of APMs reduces walk distances, decreases travel time, improves levels of service, and obviates the need for buses that contribute to roadway congestion in some cases.

The distance between the new IAF located at Concourse A and new domestic gates (locations to be determined during the alternatives task) may create challenges for passengers connecting from arriving international flights to departing domestic flights. In order to deliver these passengers with a high level of service, the chosen system(s) should be able to provide a minimum connect time of 80 minutes. This high level of connecting service should be achievable across all gates, regardless of their

locations. The APM also should provide high levels of service for passengers connecting between domestic flights.

The objective is to effectively integrate the existing STS and planned systems to simplify the inter-Airport transportation experience.

3.3.11 U.S. Customs and Border Protection Facilities

As stated in Section 3.2.4, the Port intends to construct a new IAF that will house new U.S. CBP facilities. The key characteristics and planning assumptions related to the new IAF, scheduled to open in the fourth quarter of 2019, include the following:

- The IAF will be a new multi-level, 450,000-square-foot facility located east of the current concourse A.
- An iconic aerial walkway, which will span 900 linear feet at a clear height of 85 feet over the existing taxi lane, will connect arriving international passengers from the South Satellite across the top of Concourse A to the new IAF.
- Creation of a secure international corridor on Concourse A will mean more gates for arriving international flights with a direct connection to the IAF.

3.4 Passenger Terminal Facility Requirements

This section presents the requirements for those terminal functions that will most influence the development of terminal alternatives. The requirements for those functions are presented in Table 3-2; the approaches and key assumptions in their estimation are described in the following paragraphs.

3.4.1 Gates

The number of gates and remote aircraft parking positions required to accommodate activity in the planning day flight schedules for PALS 1, 2, 3, and 4 (2019, 2024, 2029, and 2034, respectively) was estimated using LeighFisher's Gate Model.

3.4.1.1 Background and Approach

The term "gate" refers to an aircraft parking position used to enplane passengers from or deplane passengers to a passenger terminal concourse or satellite. Passengers transition between aircraft gates and a passenger terminal concourse or satellite via either an enclosed passenger boarding bridge (a gate so equipped is referred to as a "contact" gate) or on a designated path, outside the terminal concourse or satellite, located on the aircraft parking apron (a gate so equipped is referred to as a "ground-loaded" gate). Larger mainline jet aircraft are typically accommodated at contact gates whereas smaller regional jet aircraft are frequently accommodated at ground-loaded gates.

A “remote” aircraft parking position is typically located away from, but relatively near to contact gates and ground loaded gates and is also referred to as a hardstand or remain overnight aircraft parking position.

Figure 3-4 illustrates the aircraft parking ability of the Airport’s gates as configured in June 2015, when accommodating the maximum mix (i.e., number) of wide body aircraft.

Table 3-2
Summary of Major Terminal Facilities Requirements
Seattle-Tacoma International Airport

| | Existing 2014 | PAL 1 2019 | PAL 2 2024 | PAL 3 2029 | PAL 4 2034 |
|--|------------------|---------------|---------------|---------------|---------------|
| Gates | | | | | |
| International | 13 | 18 | 22 | 24 | 29 |
| Domestic | 70 | 77 | 82 | 82 | 84 |
| Total | 83 | 95 | 104 | 106 | 113 |
| Off-gate parking positions | | | | | |
| | | 28 | 31 | 37 | 44 |
| Check-In & bag drop | | | | | |
| Kiosk w/o bag check | 40 | 77 | 80 | 84 | 90 |
| Agent with bag check | 214 | 211 | 219 | 235 | 250 |
| Garage kiosk | 15 | 11 | 11 | 11 | 12 |
| Curb kiosk | 15 | 14 | 15 | 16 | 17 |
| Total | 284 | 313 | 325 | 346 | 369 |
| Passenger security screening checkpoint | | | | | |
| Number of screening lanes | 31 | 34 | 36 | 37 | 41 |
| Queue Length (ft.; max 10 min wait) | n/a | 992 | 1,050 | 1,079 | 1,196 |
| Outbound baggage system | | | | | |
| Peak hour bags | 3,564 | 4,748 | 5,911 | 7,444 | 8,135 |
| Security screening machines | 12 | 9 | 11 | 15 | 16 |
| Make-up devices | n/a | 490 | 386 | 422 | 464 |
| Early-bag storage positions | 0 | n/a | 393 | 652 | 715 |
| Domestic baggage claim | | | | | |
| Claim frontage (ft.) | 2,700 | 2,982 | 3,441 | 4,136 | 4,453 |
| Claim devices | 16 | 18 | 20 | 22 | 24 |

Sources: Requirements for gates and security screening checkpoints estimated by LeighFisher, June 2015; requirements for outbound baggage systems and domestic baggage claim estimated by Logplan, December 2016.

Figure 3-4
Illustration of Aircraft Parking Capability of Existing Gates Assuming Maximum Widebody Aircraft
 Seattle-Tacoma International Airport

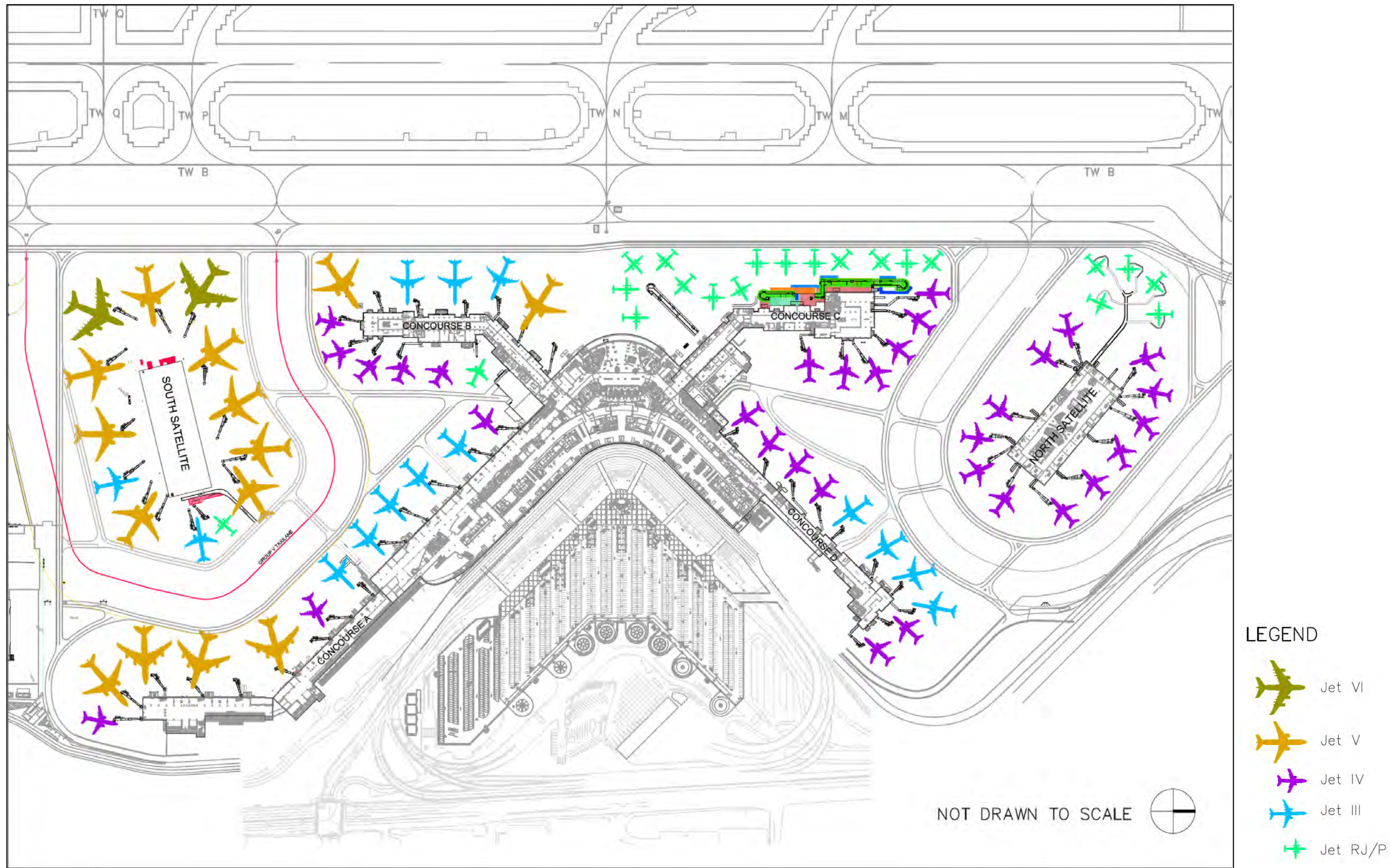

Source: Port of Seattle, June 2015.

Inputs to LeighFisher's gate model included:

- **Design day flight schedules.** A flight schedule was developed for each PAL and included aircraft type, arrival time, and departure time for each flight. The development of design day flight schedules is described in Appendix 1 of this Technical Memorandum No. 5. The schedules are available in an Excel file from the Port of Seattle Aviation Planning Department.
- **Design day flight schedules.** A flight schedule was developed for each PAL and included aircraft type, arrival time, and departure time for each flight. The development of design day flight schedules is described in Appendix 1 of this Technical Memorandum No. 5. The schedules are available in an Excel file from the Port of Seattle Aviation Planning Department.
- **Minimum arrival and departure times.** Minimum arrival and departure times represent the minimum times a flight must occupy a gate to complete an arrival or departure operation, respectively. The assumed minimum arrival and departure times are shown in Table B-1 of Appendix B of this Technical Memorandum No. 5. .
- **Earliness and lateness buffers.** Buffers allow for schedule variability by reserving blocks of gate time for flights that may be early or late relative to schedule. In the Gate Model all flights are assumed to arrive and depart on schedule. These buffers provide a time "cushion" between successive gate operations. The earliness and lateness buffers used for international flights were derived by analyzing historic operations data for SEA and represent the 85th percentile values for arrival time variance (i.e., 85 percent of the time the flight arrives within the span of time given by: [Scheduled Arrival Time -Earliness Buffer] + [Scheduled Arrival Time + Lateness Buffer]). The earliness and lateness buffers assumed are shown in Table B-2 of Appendix B of this Technical Memorandum No. 5.
- **Maneuver buffers.** Maneuver buffers are the amount of time required between scheduled gate activity to permit aircraft and equipment to be clear of the gate (i.e., the gate model applies a maneuver buffer following each scheduled departure). Maneuver buffer are also shown in Table 2 of Appendix 2 of this Technical Memorandum No. 5.
- **Minimum Turn Times.** Minimum turn times are the minimum time on gate to turn an aircraft, i.e., the minimum time to unload arriving passengers, exchange baggage, refuel, cater, and load departing passengers in quick succession. Minimum turn times input to the Gate Model are the sum of the minimum arrival and departure times shown in Table 1 in Appendix 2 of this Technical Memorandum No. 5. In the Gate Model, aircraft with scheduled ground times less than or equal to the minimum turn time had a full lateness buffer applied after the scheduled departure time. Aircraft with scheduled ground times greater than the minimum turn time had either a shortened lateness buffer or no lateness buffer applied depending on how much "slack" was available in in their scheduled ground time.

- **Aircraft towing rules.** Aircraft towing rules define when towing occurs between gates and remote aircraft parking positions and how much time is required. The Gate Model permits aircraft with scheduled ground times significantly greater than the sum of the minimum arrival and minimum departure times to be towed and parked remotely in order to make gates available to accommodate other flights. “Significantly greater” is defined as 45 minutes. All aircraft towing operations to move an idle aircraft to a remote parking position or another gate were allotted 15 minutes. Similarly, an aircraft towing operation from a remote parking position to an active gate for departure is also allotted 15 minutes.
- **Gate sharing rules.** Gate sharing rules define how gate resources may be shared among airlines (sharing was always permitted within the groups of activity for which gate requirements were estimated and sharing between groups was permitted on an exception basis). The groups of activity for which requirements were estimated are defined in the following Section 3.4.1.2.

3.4.1.2 Requirements

Gate requirements were estimated for four groups of activity:

- **International gates.** This group was appropriate because of the need for each international gate to be connected to the International Arrivals Facility by a sterile corridor and the need to prioritize international gate use for international arrivals.
- **Delta Air Lines domestic gates.** This group was appropriate because of Delta’s increasing volume of activity on the south half of the Airport and the relationship of its domestic network to its growing international hub.
- **Alaska Air Group gates.** This group was appropriate because of the Group’s market share at the Airport (greater than 50%) and dominant position.
- **Other domestic gates.** This group was a logical consequence of the three primary groups.

The requirements for remote aircraft parking positions (i.e., additional off-gate positions for remain overnight aircraft) were estimated for two groups of activity—International and Delta domestic, and other domestic—reflecting a potential split between requirements for the south and north Airport.

The aircraft parking capability of the Airport’s gates as of June 2015 is illustrated on Figure 3-4 assuming a maximum wide-body aircraft mix; the Airport’s gate inventory as of June 2015 is shown in Table 3-3. Gate requirements are summarized in Table 3-2 and Tables 3-3 through 3-7. Tables 3-4 through 3-7 summarize the Airport’s gate and remote aircraft parking requirements for PAL 1 (2019), PAL 2 (2024), PAL 3 (2029), and PAL 4 (2034), respectively.

Gate and remote aircraft parking requirements are displayed graphically in “ramp charts” (i.e., Gantt charts) produced by the gate model and included in Appendix 2. The ramp charts are also available in an Excel file from the Port of Seattle Aviation Planning Department. Although gate requirements were

estimated for both Delta Air Lines and the Alaska Air Group, a non-disclosure agreement between the Port and Delta prevents the public disclosure of information specific to Delta. Accordingly, the gate requirements information presented in this Technical Memorandum has been aggregated into two categories—international and domestic.

**Table 3-3
Existing Aircraft Gate Inventory
Seattle-Tacoma International Airport**

| | Maximum Narrow Body Mix (a) | | | | | Maximum Wide Body Mix (a) | | | | | | |
|--------------------|-----------------------------|-----------|-----------|----------|----------|---------------------------|-----------|-----------|-----------|-----------|----------|-----------|
| | RJ/TP | Jet III | Jet IV | Jet V | Jet VI | Total | RJ/TP | Jet III | Jet IV | Jet V | Jet VI | Total |
| Gates | | | | | | | | | | | | |
| International | 1 | 1 | 6 | 5 | 2 | 15 | 1 | -- | 2 | 8 | 2 | 13 |
| Domestic | 26 | 31 | 18 | 2 | -- | 77 | 20 | 32 | 12 | 6 | -- | 70 |
| Total gates | 27 | 32 | 24 | 7 | 2 | 92 | 21 | 32 | 14 | 14 | 2 | 83 |

(a) The number of aircraft parking positions that can be simultaneously occupied on a given ramp area varies based on configuration and layout. Flexibly configured aprons can accommodate various discrete combinations of small and large aircraft. The narrow body mix presents the upper bound of the number of aircraft that can be accommodated assuming the smallest aircraft size and the wide body mix presents the lower bound assuming the largest aircraft size.

The column headings refer to the maximum aircraft size accommodated at the gates.

RJ/TP = a gate capable of accommodating aircraft no larger than a regional jet or turbo prop aircraft

Jet III = a gate capable of accommodating aircraft no larger than airplane design group III (i.e., wingspans less than 118 feet)

Jet IV = a gate capable of accommodating aircraft no larger than airplane design group III (i.e., wingspans less than 171 feet)

Jet V = a gate capable of accommodating aircraft no larger than airplane design group III (i.e., wingspans less than 214 feet)

Jet VI = a gate capable of accommodating aircraft no larger than airplane design group III (i.e., wingspans less than 262 feet)

Source: LeighFisher, 2015.

Table 3-4
Existing Gate and Off-Gate Aircraft Parking Requirements – PAL 1 (2019)
 Seattle-Tacoma International Airport

| | Aircraft size (a) | | | | | Total |
|-------------------------------------|-------------------|---------|--------|-------|--------|-------|
| | RJ/TP | Jet III | Jet IV | Jet V | Jet VI | |
| Gates | | | | | | |
| International | -- | -- | 2 | 16 | -- | 18 |
| Domestic | 19 | 47 | 10 | 1 | -- | 77 |
| Total gate requirement | 19 | 47 | 12 | 17 | -- | 95 |
| Off-gate parking | | | | | | |
| Total demand | 6 | 31 | 5 | 4 | -- | 46 |
| Demand accommodated at gates (b) | 5 | 11 | 2 | -- | -- | 18 |
| Off-gate parking requirement | 1 | 20 | 3 | 4 | -- | 28 |

(a) The column headings refer to the maximum aircraft size accommodated at the gates.

RJ/TP = a gate capable of accommodating aircraft no larger than a regional jet or turbo prop aircraft

Jet III = a gate capable of accommodating aircraft no larger than airplane design group III (i.e., wingspans less than 118 feet)

Jet IV = a gate capable of accommodating aircraft no larger than airplane design group III (i.e., wingspans less than 171 feet)

Jet V = a gate capable of accommodating aircraft no larger than airplane design group III (i.e., wingspans less than 214 feet)

Jet VI = a gate capable of accommodating aircraft no larger than airplane design group III (i.e., wingspans less than 262 feet)

(b) Off-gate parking demand that could be accommodated on available gates was determined by visual inspection of Gate Model ramp charts.

Notes:

Gate and off-gate parking requirements shown are based on the corresponding ramp chart, located in Appendix 2, and assume a maximum wide body configuration.

Source: LeighFisher, 2015.

Table 3-5
Existing Gate and Off-Gate Aircraft Parking Requirements – PAL 2 (2024)
 Seattle-Tacoma International Airport

| | Aircraft size (a) | | | | | Total |
|-------------------------------------|-------------------|---------|--------|-------|--------|-------|
| | RJ/TP | Jet III | Jet IV | Jet V | Jet VI | |
| Gates (a) | | | | | | |
| International | -- | 1 | 2 | 19 | -- | 22 |
| Domestic | 21 | 50 | 10 | 1 | -- | 82 |
| Total gate requirement | 21 | 51 | 12 | 20 | -- | 104 |
| Off-gate parking | | | | | | |
| Total demand | 7 | 38 | 4 | 3 | -- | 52 |
| Demand accommodated at gates (b) | 5 | 16 | - | - | -- | 21 |
| Off-gate parking requirement | 2 | 22 | 4 | 3 | - | 31 |

(a) The column headings refer to the maximum aircraft size accommodated at the gates.

RJ/TP = a gate capable of accommodating aircraft no larger than a regional jet or turbo prop aircraft

Jet III = a gate capable of accommodating aircraft no larger than airplane design group III (i.e., wingspans less than 118 feet)

Jet IV = a gate capable of accommodating aircraft no larger than airplane design group III (i.e., wingspans less than 171 feet)

Jet V = a gate capable of accommodating aircraft no larger than airplane design group III (i.e., wingspans less than 214 feet)

Jet VI = a gate capable of accommodating aircraft no larger than airplane design group III (i.e., wingspans less than 262 feet)

(b) Off-gate parking demand that could be accommodated on available gates was determined by visual inspection of Gate Model ramp charts.

Notes:

Gate and off-gate parking requirements shown are based on the corresponding ramp chart, located in Appendix 2, and assume a maximum wide body configuration.

Source: LeighFisher, 2015.

Table 3-6
Existing Gate and Off-Gate Aircraft Parking Requirements – PAL 3 (2029)
 Seattle-Tacoma International Airport

| | Aircraft size (a) | | | | | Total |
|-------------------------------------|-------------------|---------|--------|-------|--------|-------|
| | RJ/TP | Jet III | Jet IV | Jet V | Jet VI | |
| Gates (a) | | | | | | |
| International | -- | -- | 2 | 22 | -- | 24 |
| Domestic | 21 | 51 | 8 | 2 | -- | 82 |
| Total gate requirement | 21 | 51 | 10 | 24 | -- | 106 |
| Off-gate parking | | | | | | |
| Total demand | 7 | 42 | 6 | 4 | -- | 59 |
| Demand accommodated at gates (b) | 4 | 15 | 3 | -- | -- | 22 |
| Off-gate parking requirement | 3 | 27 | 3 | 4 | -- | 37 |

(a) The column headings refer to the maximum aircraft size accommodated at the gates.

RJ/TP = a gate capable of accommodating aircraft no larger than a regional jet or turbo prop aircraft

Jet III = a gate capable of accommodating aircraft no larger than airplane design group III (i.e., wingspans less than 118 feet)

Jet IV = a gate capable of accommodating aircraft no larger than airplane design group III (i.e., wingspans less than 171 feet)

Jet V = a gate capable of accommodating aircraft no larger than airplane design group III (i.e., wingspans less than 214 feet)

Jet VI = a gate capable of accommodating aircraft no larger than airplane design group III (i.e., wingspans less than 262 feet)

(b) Off-gate parking demand that could be accommodated on available gates was determined by visual inspection of Gate Model ramp charts.

Notes:

Gate and off-gate parking requirements shown are based on the corresponding ramp chart, located in Appendix 2, and assume a maximum wide body configuration.

Source: LeighFisher, 2015.

Table 3-7
Existing Gate and Off-Gate Aircraft Parking Requirements – PAL 4 (2034)
 Seattle-Tacoma International Airport

| | Aircraft size (a) | | | | | Total |
|-------------------------------------|-------------------|---------|--------|-------|--------|-------|
| | RJ/TP | Jet III | Jet IV | Jet V | Jet VI | |
| Gates (a) | | | | | | |
| International | -- | 2 | -- | 27 | -- | 29 |
| Domestic | 12 | 63 | 6 | 3 | -- | 84 |
| Total gate requirement | 12 | 65 | 6 | 30 | -- | 113 |
| Off-gate parking | | | | | | |
| Total demand | 7 | 47 | 5 | 7 | -- | 66 |
| Demand accommodated at gates(b) | 3 | 17 | 2 | - | -- | 22 |
| Off-gate parking requirement | 4 | 30 | 3 | 7 | -- | 44 |

- (a) The column headings refer to the maximum aircraft size accommodated at the gates.
- RJ/TP = a gate capable of accommodating aircraft no larger than a regional jet or turbo prop aircraft
 - Jet III = a gate capable of accommodating aircraft no larger than airplane design group III (i.e., wingspans less than 118 feet)
 - Jet IV = a gate capable of accommodating aircraft no larger than airplane design group III (i.e., wingspans less than 171 feet)
 - Jet V = a gate capable of accommodating aircraft no larger than airplane design group III (i.e., wingspans less than 214 feet)
 - Jet VI = a gate capable of accommodating aircraft no larger than airplane design group III (i.e., wingspans less than 262 feet)
- (b) Off-gate parking demand that could be accommodated on available gates was determined by visual inspection of Gate Model ramp charts.

Notes:
 Gate and off-gate parking requirements shown are based on the corresponding ramp chart, located in Appendix 2, and assume a maximum wide body configuration.

Source: LeighFisher, 2015.

3.4.2 Airline Check-in and Baggage Drop

Requirements were developed using spreadsheet models, anticipated peak-period passenger activity for each airline at each PAL, and appropriate allowances for technology and process change. The requirements are shown in Table 4-2. Key observations from the requirements analyses were (1) the need for kiosks without bag check will increase rapidly, and (2) the need for additional agent positions with bag drop will not increase significantly until PAL 3.

3.4.3 Passenger Security Screening

Requirements for security screening checkpoint lanes were developed using spreadsheet models, anticipated peak-period passenger activity for each airline at each PAL, anticipated processing rates and lane types (i.e., TSA PreCheck, premium passengers, and general passengers), and reasonable expectations related to technology and process change. Aside from unforeseen and significant changes in security screening objectives, the requirement for the number of screening lanes and queue length is expected to steadily increase as activity increases. The requirements, shown in Table 3-2, assume a single checkpoint location and could increase depending on the alternative considered (e.g., the number of checkpoint locations).

3.4.4 Baggage Handling Systems

Baggage handling systems requirements were estimated using spreadsheet-based tools, planning assumptions and parameters based on Airport-specific data, design-day flight schedules for PAL 1 through PAL 4, and appropriate allowances for technology and process change. BHS requirements were developed for domestic and international outbound baggage makeup, inbound baggage handling, and domestic claim facilities. International claim requirements are included in the ongoing IAF design program.

3.4.4.1 Domestic and International Outbound Baggage Makeup

For the purposes of the SAMP, we assumed that additional outbound makeup space and devices will be provided where future facility expansion allows. The approach is to provide carousels capable of providing outbound makeup for more than one gate per device. It is important to recognize that baggage processing rates could be affected by the use of one or two baggage screening systems as well as the introduction of an Early Bag Storage (EBS) system. For the purposes of estimating requirements, we assumed an EBS system will be in place and operating by 2019.

The requirements for domestic and international outbound baggage handling systems are shown in Table 3-2.

3.4.4.2 Inbound Baggage Handling

The future concept of operation within the existing passenger terminal is to tug inbound baggage where it makes sense. If situations were to exist where gates are too far from bag claim devices for tugging to be practical, then high speed individual carrier systems (ICS) might be considered.

The difficulty is planning for more conventional methods regarding inbound baggage. There is very little space available for baggage sortation systems within the existing passenger terminal. The space that is available is occupied by outbound systems or essential functions. As additional baggage claim devices are added to meet claim requirements, additional claim feed belts will need to be added as well.

3.4.4.3 Domestic Baggage Claim

Recommended presentation lengths for the domestic baggage claim devices and the number of devices were developed based on the design day flight schedules and passenger profile metrics for the Airport. These passenger metrics include: originating and departing percentages; and the percentage of arriving passengers claiming a bag.

The requirements for domestic baggage claim are shown in Table 3-2.

3.4.5 U.S. Customs and Border Protection Facilities

The new IAF, scheduled to open in the fourth quarter of 2019, is currently being designed. Therefore, the SAMP did not include estimates of requirements for the IAF. However, the new IAF is being designed to:

- Increase passenger processing capacity by more than double to 2,600 passengers per hour (currently the Airport experiences daily peak passenger levels averaging over 2,000 passengers per hour for a facility designed for only 1,200 per hour).
- Nearly double the number of existing gates capable of serving international wide-body aircraft from 12 to 20 gates.
- More than double Passport Check booths and kiosks (from 30 to 80 booths).
- Increase the size and number of bag claim carousels from four to seven.
- Create a single bag claim process, eliminating the need for international passengers to ride a train to baggage claim.
- Create direct access from the IAF to ground transportation located at the Airport drives or garage.
- Reduce minimum passenger connection time to 75 minutes

Ground Access and Parking

This chapter presents assessments of existing ground access and parking facilities and summarizes the requirements that must be satisfied to accommodate the aviation activity forecast through the 20-year planning period.

4.1 Introduction

The chapter presents the requirements for meeting forecast ground transportation and parking demand for PALs 1 through 4 (i.e., 2019, 2024, 2029, and 2034, respectively) and the associated peak hour activity.

4.2 Existing Facilities and Operations

The Airport's ground access and parking facilities include off-Airport access roadways, on-Airport access roadways, terminal-area circulation roadways, curbside roadways, commercial vehicle facilities, public transit facilities, public parking, employee parking, rental car facilities, and pedestrian and bicycle facilities.

4.2.1 Off-Airport Access Roadways

Off-Airport roads of particular importance for the Airport include the surrounding state and regional highway network (i.e., I-5, I-405, SR 518, and SR 509) as well as local roadways (i.e., SR 99 / International Boulevard, S. 188th St, S. 170th St, and S. 160th St) that provide access to and from the Airport. Although the Port does not control these off-Airport access roadways, and their future requirements are outside the scope of the SAMP, the roads were evaluated by Port staff using the Sea-Tac airport travel demand forecasting model (the model). This model directly ties in the Puget Sound Regional Council (PSRC) land use, employment, trip generation, and travel patterns from areas outside the Airport and is integrated with data related to air passenger travel for the Airport. The model is based on year 2010 and reflects conditions during a peak hour in the afternoon (the peak period for regional traffic in the vicinity of the Airport). The model was used to develop volume forecasts for the peak hour and does not directly indicate LOS associated with these volumes. The performance of the roads was assessed using the volume/capacity ratio (V/C). Breakdown (or LOS F) occurs when the V/C ratio exceeds 1.0. Operations immediately downstream may reflect LOS E conditions.

Figures 4-1 and 4-2 depict key results of the 2010 model. Figure 4-1 depicts Airport versus non-Airport traffic volumes on roadways in and around the Airport. As shown, on-Airport and on SR 518 (between the Airport and I-5) the Airport contributes a significant share of the total traffic during the peak hour. On I-5, SR 509, and International Blvd., however, the Airport contributes a very small share of the total volume. Figure 4-1 also indicates that a high share of Airport traffic (87%) enters the Airport from the north via the North Airport Expressway while the remainder (13%) enters from the south via City of SeaTac streets. However, approximately 74% of Airport traffic is generated from areas

north of the Airport. This discrepancy reflects that a high share of traffic generated to the south uses I-5 and SR 518 to travel to the Airport and therefore, enters Airport property from the north.

Figure 4-2 depicts the model's V/C ratios for 2010. As shown, in 2010 most off- Airport roads near the Airport had a V/C ratio of less than 1. Key regional access routes to and from the Airport, such as the I-5/I-405 interchange, I-405, and southbound I-5 (south of the Airport), had V/C ratios exceeding 1. According to Port staff, even though eastbound SR 518 had available capacity in the afternoon, congestion at the I-5/I-405 interchange caused traffic to back up along SR 518.

Other conclusions, based on assessing model results, are that congestion from on-Airport roadways occasionally reaches the SR 518 corridor, creating turbulence on westbound SR 518.

4.2.2 On-Airport Access Roadways

Figure 5-3 depicts key on-Airport access roadways (including ramps connecting to SR 518 which, while outside of Airport property, are used almost exclusively by Airport-related traffic). Peak hour 2010 volumes, as identified by the regional model, are provided in Table 4-1. As described in Section 4.2.1, approximately 87% of peak hour Airport traffic accesses the Airport to and from the north via the North Airport Expressway. The remaining volumes enter via the intersection at South 182nd St. and International Blvd. and via ramps connecting South 170th Street and the North Airport Expressway. As shown in Table 4-1, volume/capacity ratios on these roadways are generally 0.6 or lower during the regional peak hour. However, key access roadways, such as the southbound North Airport Expressway, experience congestion due to deficiencies on terminal-area roadways (described in Section 4.2.3), which cause traffic to back up onto access roadways.

Figure 4-1
Regional Travel Model Airport and Non-Airport Peak Hour Traffic Volumes - 2010
Seattle-Tacoma International Airport

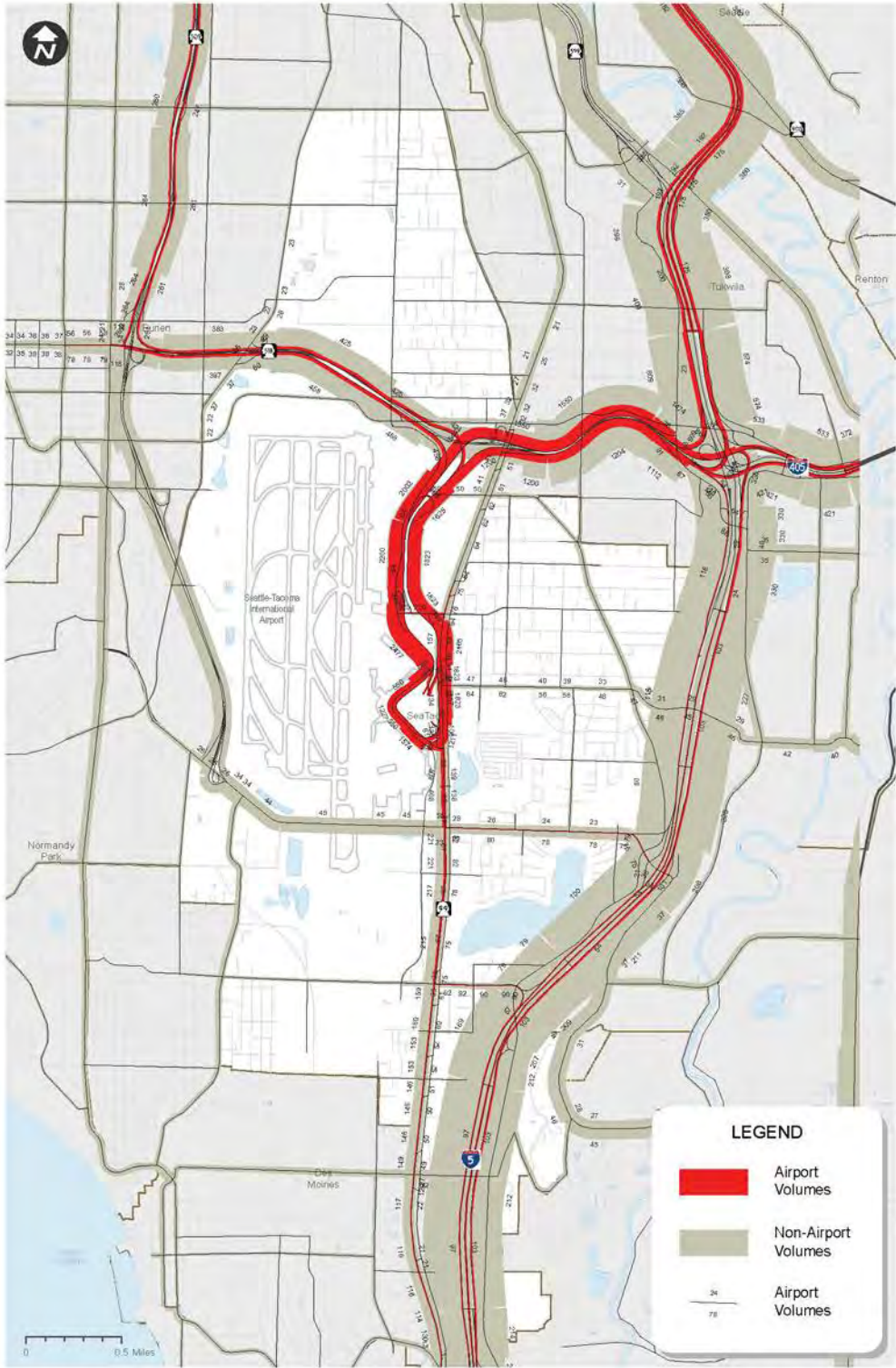

Total Volumes - 2010 Existing

DRAFT FIGURE

Source: Port of Seattle, 2017.

Figure 4-2
Regional Travel Model Volume/Capacity Ratios - 2010
Seattle-Tacoma International Airport

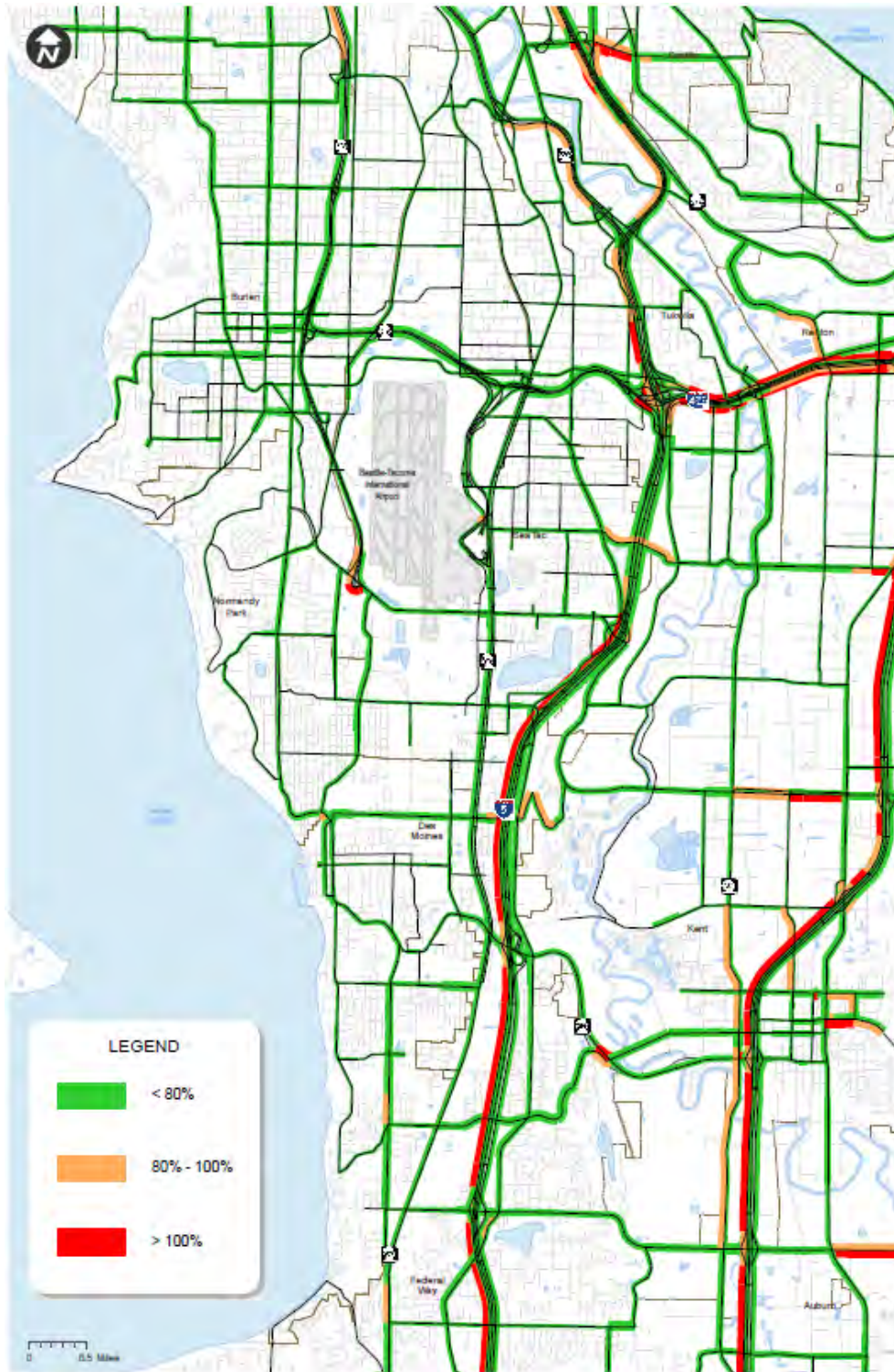

VC Ratio - 2010 Existing

DRAFT FIGURE

Source: Port of Seattle, 2017.

Figure 4-3
On-Airport Access Roadways
 Seattle-Tacoma International Airport

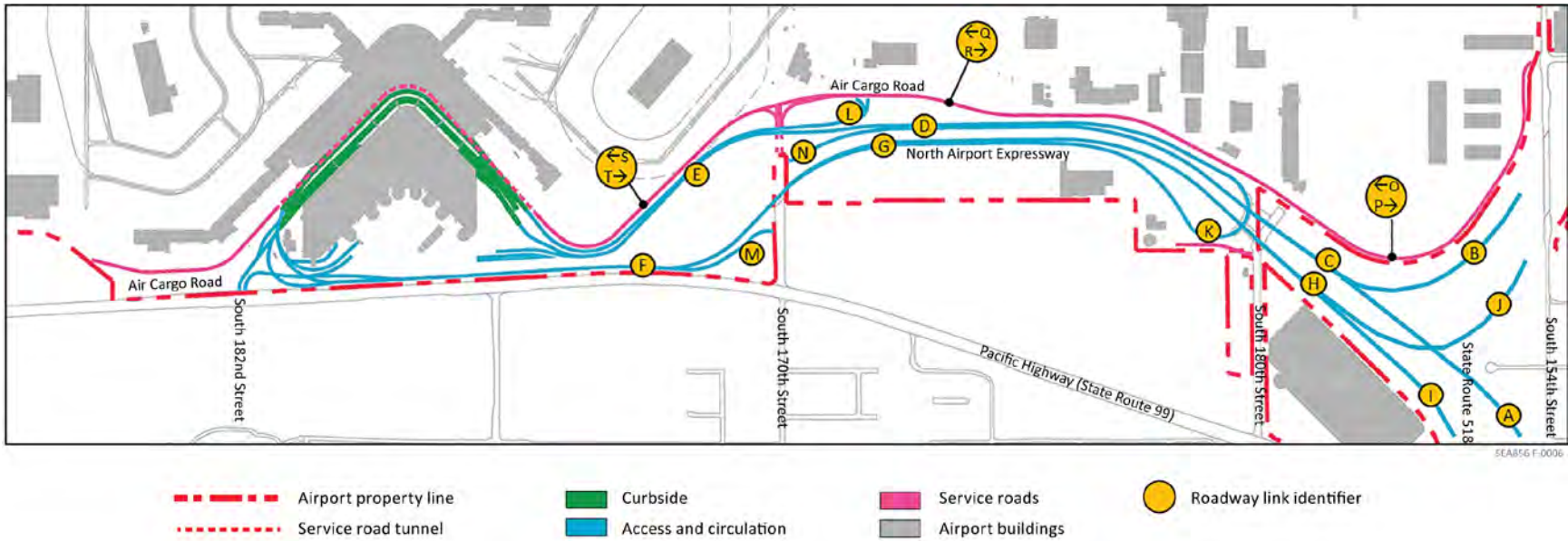

Note: Roadway link identifiers are keyed to data presented in Table 4-1

Source: InterVISTAS, from background map provided by Shen Consulting.

Table 4-1
Existing On-Airport Access Roadway Volumes, Capacities, and Levels of Service
 Seattle-Tacoma International Airport

| | Description | Assumed speed | Basic capacity per lane (a) | Heavy vehicle factor | Population factor | Capacity per lane | Lanes | Capacity | 2010 volume (b) | Volume/capacity ratio | Level of service (a) |
|---|--|---------------|-----------------------------|----------------------|-------------------|-------------------|-------|----------|-----------------|-----------------------|----------------------|
| A | Ramp from SR 518, westbound | 50 | 2,000 | 0.95 | 0.85 | 1,620 | 2 | 3,240 | 1,590 | 0.49 | C |
| B | Ramp from SR 518, eastbound | 40 | 1,750 | 0.95 | 0.85 | 1,410 | 1 | 1,410 | 630 | 0.45 | C |
| C | North Airport Expressway, southbound, prior to return-to-terminal ramp | 40 | 1,750 | 0.95 | 0.85 | 1,410 | 3 | 4,230 | 2,220 | 0.52 | C |
| D | North Airport Expressway, southbound, after return-to-terminal ramp | 40 | 1,750 | 0.95 | 0.85 | 1,410 | 3 | 4,230 | 2,418 | 0.57 | C |
| E | Terminal area entrance | 30 | 1,450 | 0.95 | 0.85 | 1,170 | 4 | 4,680 | 2,477 | 0.53 | C |
| F | Terminal area exit to north | 40 | 1,750 | 0.95 | 0.85 | 1,410 | 4 | 5,640 | 2,367 | 0.42 | C |
| G | North Airport Expressway, northbound, prior to return-to-terminal ramp | 40 | 1,750 | 0.95 | 0.85 | 1,410 | 5 | 7,050 | 2,025 | 0.29 | B |
| H | North Airport Expressway, northbound, after return-to-terminal ramp | 40 | 1,750 | 0.95 | 0.85 | 1,410 | 3 | 4,230 | 1,827 | 0.43 | C |
| I | Ramp to SR 518, eastbound | 50 | 2,000 | 0.95 | 0.85 | 1,620 | 2 | 3,240 | 1,341 | 0.41 | C |
| J | Ramp to SR 518, westbound | 45 | 1,900 | 0.95 | 0.85 | 1,530 | 2 | 3,060 | 486 | 0.16 | A |
| K | Return-to-terminal ramp | 25 | 1,250 | 0.95 | 0.85 | 1,010 | 2 | 2,020 | 198 | 0.10 | A |
| L | On-ramp from Air Cargo Road | 25 | 1,250 | 0.8 | 1.0 | 1,000 | 2 | 2,000 | 277 | 0.14 | A |
| M | Northbound exit to South 170th Street | 25 | 1,250 | 0.8 | 1.0 | 1,000 | 1 | 1,000 | 342 | 0.34 | B |
| N | Southbound exit to South 170th Street | 25 | 1,250 | 1.0 | 1.0 | 1,250 | 1 | 1,250 | 218 | 0.17 | A |
| O | Air Cargo Road, southbound, north of South 160th Street | 35 | 1,600 | 0.75 | 1.0 | 1,200 | 2 | 2,400 | 215 | 0.09 | A (c) |
| P | Air Cargo Road, northbound, north of South 160th Street | 35 | 1,600 | 0.75 | 1.0 | 1,200 | 2 | 2,400 | 143 | 0.06 | A (c) |
| Q | Air Cargo Road, southbound, north of South 170th Street | 35 | 1,600 | 0.75 | 1.0 | 1,200 | 1 | 1,200 | 114 | 0.10 | A (c) |
| R | Air Cargo Road, northbound, north of South 170th Street | 35 | 1,600 | 0.75 | 1.0 | 1,200 | 1 | 1,200 | 39 | 0.03 | A (c) |
| S | Air Cargo Road, southbound, south of South 170th Street | 35 | 1,600 | 0.75 | 1.0 | 1,200 | 1 | 1,200 | -- | 0.00 | A (c) |
| T | Air Cargo Road, northbound, south of South 170th Street | 35 | 1,600 | 0.75 | 1.0 | 1,200 | 1 | 1,200 | -- | 0.00 | A (c) |

(a) Based on Airport Cooperative Research Program (ACRP) Report 40, Table 4-1.

(b) Provided by the Port of Seattle.

(c) Traffic conditions also impacted by intersections and truck turning movements.

Source: InterVISTAS, from traffic volume data provided by the Port of Seattle.

4.2.3 Terminal-Area Circulation Roadways

Figure 4-4 depicts key terminal-area circulation roadways and identifies the four that currently experience the highest volumes and congestions.

Figure 4-4
Key Terminal-Area Roadways
 Seattle-Tacoma International Airport



Source: InterVISTAS Inc., 2016.

Table 4-2 summarizes the 2014 volume, capacity, and level of service for each roadway segment identified in Figure 5-4. As shown, of the four key segments, the approach to the Lower Drive (which, in addition to curbside traffic, includes all traffic entering the 3rd floor courtesy vehicle lanes and approaching the Main Garage from the north) and the exit from the Upper Drive operate at level-of-service E. These conditions result in traffic backing up into upstream facilities, such as the Upper Drive and North Airport Expressway.

Table 4-2
Terminal-Area Circulation Existing Conditions
 Seattle-Tacoma International Airport

| Roadway segment (a) | Existing lanes | Per lane capacity (vehicles per hour) | Capacity (vehicles per hour) | Volume (b) | Volume/capacity ratio | Level of service |
|--|----------------|---------------------------------------|------------------------------|------------|-----------------------|------------------|
| A. Approach to Lower Drive | 2 | 1,250 | 2,500 | 2,110 | 0.84 | E |
| B. Approach to Upper Drive | 2 | 1,250 | 2,500 | 1,240 | 0.50 | C |
| C. Exit from Upper Drive to North Airport Expressway | 1 | 1,450 | 1,450 | 1,240 | 0.86 | E |
| D. Exit from Lower Drive to North Airport Expressway | 2 | 1,450 | 2,900 | 1,210 | 0.42 | C |

(a) The locations for roadway segments are identified on Figure 5-4.

(b) Volumes represent the peak hour for the specific roadway and may not be concurrent.

Source: InterVISTAS Inc., 2016.

4.2.4 Curbside Roadways

Currently, the Airport Main Terminal is accessed by two curbside roadways: the Upper Drive and Lower Drive. The Upper Drive provides approximately 1,200 linear feet of curb and four roadway lanes while the Lower Drive provides approximately 1,500 linear feet of curb and five roadway lanes. Approximately one-third of the curb length on the Lower Drive is reserved for public transit buses and shuttle buses serving the rental car facility.

Table 4-3 summarizes 2014 peak period traffic volumes on each curbside roadway, the curbside utilization ratio, the roadway volume/capacity ratios, and the corresponding level-of-service. As shown, with the assumed dwell times most of the curbs would operate in acceptable conditions. In practice, however, the curbs are extremely congested due to:

- Dwell times typically exceed those shown on Table 4-3, resulting in higher numbers of parked vehicles. The dwell times represent typical achievable dwell times when curbside dwell policies are enforced.
- Near the rental car shuttle loading areas, curb area and roadway capacity is reduced to facilitate shuttle bus maneuverability.
- On the Lower Drive, public transit buses, rental car shuttles, and other large vehicles may off-track around the curve in the middle of the roadway and obstruct adjacent lanes.

Table 4-3
Curbside Roadway Existing Conditions
 Seattle-Tacoma International Airport

| | Peak hour volume | Dwell times (minutes) | Average spaces | Peak spaces | Occupied curb length | Curb utilization | Level of service (a) | Roadway capacity (a) | Roadway volume/capacity ratio | Level of service (a) |
|-----------------------------------|------------------|-----------------------|----------------|-------------|----------------------|------------------|----------------------|----------------------|-------------------------------|----------------------|
| Upper Drive | | | | | | | | | | |
| Private vehicles | 953 | 2 | 31.8 | - | - | - | - | - | - | - |
| Taxicabs | 140 | 2 | 4.7 | - | - | - | - | - | - | - |
| Limousines | 96 | 2 | 3.2 | - | - | - | - | - | - | - |
| Shared ride vans | 22 | 2.5 | 0.9 | - | - | - | - | - | - | - |
| Scheduled vans/buses (Airporters) | 13 | 6 | 1.3 | - | - | - | - | - | - | - |
| Charter buses | 2 | 10 | 0.3 | - | - | - | - | - | - | - |
| Other vehicles | <u>14</u> | <u>3</u> | <u>0.7</u> | - | - | - | - | - | - | - |
| Total | 1,240 | | 42.9 | 54 | 1,387 | 1.16 | C | 2,680 | 0.46 | C |
| Lower Drive | | | | | | | | | | |
| Private vehicles | 1,104 | 2 | 36.8 | 50 | 1,250 | 1.19 | C | - | - | - |
| Rental car shuttle | 138 (b) | 3.5 | 8.1 | 8 | 480 | 1.33 | F (c) | - | - | - |
| Public transit | <u>8 (c)</u> | 2 | 0.3 | 2 | 120 | 1.00 | C | - | - | - |
| Total | 1,250 | | | | | | | 3,100 | 0.40 | C |

- (a) Based on Airport Cooperative Research Program (ACRP) Report 40, Table 5-2.
 (b) Based on schedule required for 2,000 passengers per hour (55 second headways).
 (c) This vehicle cannot double-park; curb utilization exceeding 1 represents deficient conditions.
 (d) Assumes 3 routes operating in two directions at 10-minute headways.

Source: InterVISTAS, October 2016.

4.2.5 Commercial Vehicle Facilities

The services provided by commercial vehicle operators at the Airport are provided by the following categories of services, service providers, and vehicles:

- **On-demand services.** These services are provided by taxis, limousines, and door-to-door vans which are currently allowed to drop-off customers on the Departures Curbside and pick-up customers in the Ground Transportation Center. Staging facilities are currently provided adjacent to the passenger pick-up area, and remote holding facilities are provided in the S 160th Street Ground Transportation Lot.
- **Pre-arranged services.** These services are provided by limousines and town cars which are currently allowed to drop-off customers on the Departures Curbside and pick-up customers either in the Ground Transportation Center or Arrivals Curbside (vehicle staged in the Ground Transportation Center). No remote holding facilities are provided for these services.
- **Transportation network companies.** These companies (e.g., Uber and Lyft) are currently allowed to drop-off customers on the Departures Curbside and pick-up customers in the Ground Transportation Center. Remote holding facilities are provided for these services in the South 160th St Ground Transportation Lot. (This service was introduced at the Airport after the 2014 base year and thus
- **Courtesy vehicles.** These include courtesy vehicles for off-site hotels/motels and parking facilities which are required to drop-off and pick-up customers in the Courtesy Vehicle Plaza. No staging or holding facilities are provided for these services.
- **Airporters.** These are typically scheduled services between regional destinations (e.g., San Juan Islands and Olympia) and the Airport. Airporters are currently allowed to drop-off customers on the Departures Curbside and pick-up customers in the South Ground Transportation Lot. Remote holding facilities are provided in the South Ground Transportation Holding Lot.
- **Rental car buses.** These include the consolidated bus service that transports rental car customers between the Terminal and the remote consolidated Rental Car Facility. Customers are currently dropped-off and picked-up from the dedicated busing zones at the north and south ends of the Arrivals curbside. Staging facilities are provided at the Rental Car Facility.
- **Cruise charter buses.** These include charter buses that transport passengers between the downtown cruise terminals and the Airport. Cruise ship charter buses currently operate from May through September and are allowed to drop-off customers in the North Charter Bus Lot and South Ground Transportation Lot, and pick-up customers in the South Ground Transportation Lot. Panel vans are also used to help transport cruise passenger baggage from the Airport to the cruise terminals downtown. Remote holding facilities are provided in the South Ground Transportation Holding Lot.

- **Other charter buses.** These include military and other group charter buses which are currently allowed to drop-off customers on the Departures Curbside and pick-up customers in the South Ground Transportation Lot. Remote holding facilities are provided in the South Ground Transportation Holding Lot.
- **Public transit.** Public transit services are operated by Metro, Sound Transit, Pierce Transit, and Paratransit. These services currently drop-off and pick-up transit customers on International Blvd and the south end of the Arrivals curbside.
- **Crew vans.** These services are scheduled by the airlines, dependent upon the need to overnight airline crews in Seattle, and currently allowed to drop-off customers on the Departures Curbside or Courtesy Vehicle Plaza, and pick-up in the South Ground Transportation Lot of Courtesy Vehicle Plaza.

Table 4-4 summarizes the existing commercial facilities utilized for each transit mode. As shown, existing facilities are generally sufficient to accommodate the 2014 demand. The commercial vehicle lanes on the 3rd floor of the Main Garage, however, experience congestion due to limited capacity of the two-lane roadway and multiple pedestrian crossings.

Table 4-4
Summary of Existing Commercial Vehicle Facilities
 Seattle-Tacoma International Airport

| Service | Facility capacity (spaces) | | | | 2014 Demands | | | |
|-----------------------------|----------------------------|--------|---------|---------|--------------|--------|---------|---------|
| | Drop-off | Pickup | Staging | Holding | Drop-off | Pickup | Staging | Holding |
| On Demand Services | | | | | | | | |
| Taxis | n.a. (a) | 13 | 70 | 98 | n.a. | 9 | 48 | 98 |
| Town Cars/Limousines | n.a. (a) | 2 | 5 | n.a. | n.a. | 1 | 2 | n.a. |
| Door-to-Door Vans | n.a. (a) | 8 | n.a. | n.a. | n.a. | 3 | 5 | n.a. |
| Town Cars/Limousines | n.a. (a) | 48 | n.a. | n.a. | n.a. | 8 | n.a. | n.a. |
| Trans Network Companies | n.a. (a) | 57 | n.a. | 43 | n.a. | n.a. | n.a. | n.a. |
| Courtesy Vehicles (c) | n.a. (b) | | n.a. | n.a. | n.a. | 20 | n.a. | n.a. |
| Crew Vans | n.a. (a) (b) | 22 | n.a. | n.a. | n.a. | 1 | n.a. | n.a. |
| Downtown Shuttle | n.a. (a) | | n.a. | n.a. | n.a. | 2 | n.a. | n.a. |
| Airporters (Vans and buses) | n.a. (a) | 3 | n.a. | 6 | n.a. | 2 | n.a. | 6 |
| Charter Buses | | | | | | | | |
| Cruise (Bus) | 20 | | n.a. | 15 | 8 | 6 | n.a. | 15 |
| Cruise (Truck) | n.a. | 6 | n.a. | n.a. | n.a. | 6 | n.a. | n.a. |

(a) Service drops off customers on the Departures curbside.

(b) Service drops off and picks up customers in the Courtesy Vehicle Plaza.

(c) Service drops off and picks up customers in the same stall.

Source: InterVISTAS and Port of Seattle, June 2016.

4.2.6 Public Parking

Public parking is currently provided in the Main Garage, the Doug Fox Lot (operated by a third-party concessionaire), and multiple off-Airport parking and hotel/motel operators.

Existing needs (and future requirements) are based on a 'design day' that represents the parking demand for a typical busy day during the year, but does not represent the highest day of the year. At an airport, there may often be a limited number of days, such as holidays, where parking demand is significantly higher than during all other days of the year. Airport operators often elect to not plan for permanent parking facilities (such as garages and paved surface lots) that would accommodate the highest days of the year because some of those spaces would rarely be used and thus, not generate revenue sufficient to justify paying to construct the space. Therefore, the design day is used as the level of demand an airport aims to accommodate with permanent parking facilities.

The design day may also occur (and at many airports, does occur) during a time of the year outside of an airport's peak month for airline passenger activity. This is because an airport's peak month for airline passengers may reflect high volumes of leisure travelers and/or visitors (as opposed to residents), both of which are typically less likely to park at the airport for the duration of their trip. These customers may generate high volumes of parking transactions, but as these transactions are typically for less than 4 hours each, they do not result in high numbers of accumulated parked vehicles. Therefore, an airport's design day for parking is more likely to occur during a month experiencing high volumes of local passengers travelling for business reasons as these passengers are more likely to park at the airport for the duration of their trip. These long-duration transactions, while lower in volume, typically result in high numbers of accumulated parked vehicles as each vehicle may remain parked for several days.

Figure 4-5 depicts combined monthly long-duration parking transactions (transactions exceeding 24 hours) for the Main Garage and off-Airport parking facilities located in the cities of SeaTac, Tukwila, and Burien. As shown, from 2010 through 2013 the highest number of long-duration transactions occurred in October whereas the peak month for airline passengers was typically July or August.

Figure 4-5
Long-Duration Parking Transactions, 2010 – 2013
 Seattle-Tacoma International Airport

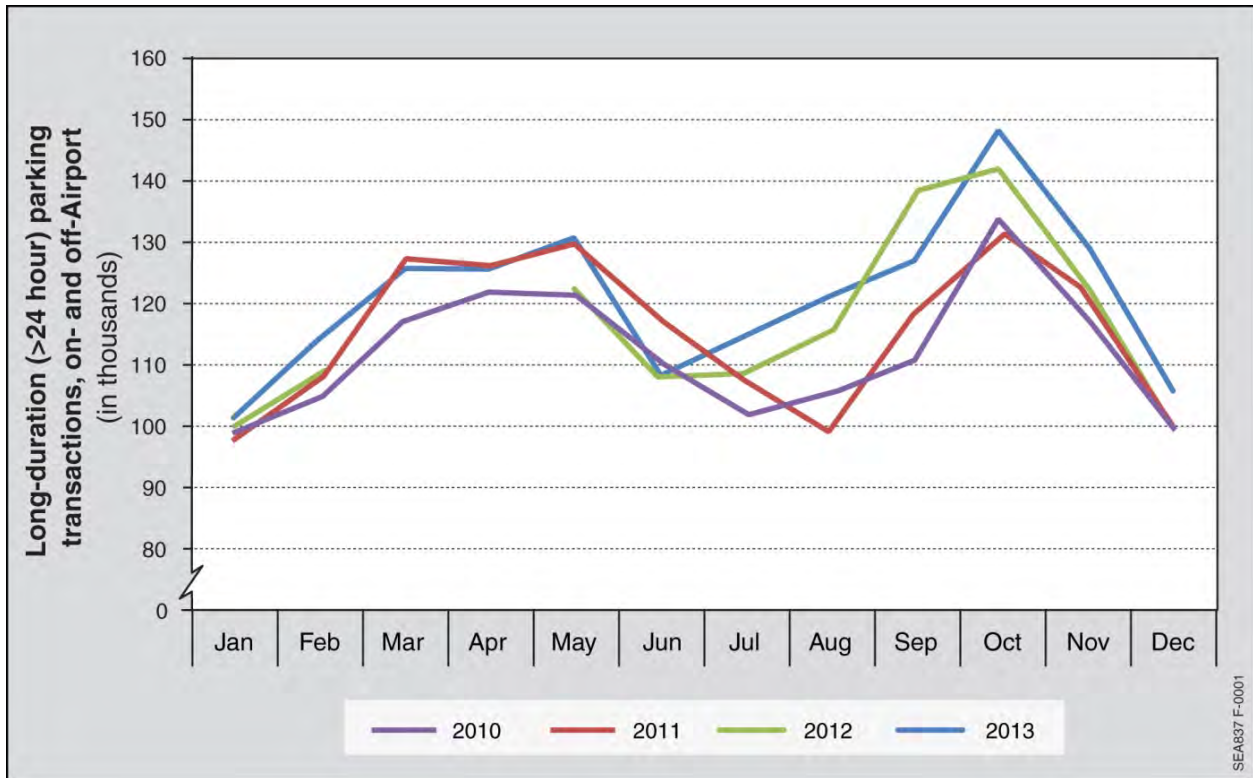

Source: LeighFisher, from data provided by the Port of Seattle.

Because parking accumulations are typically comprised mostly of long-duration parkers and thus, reflect the accumulation over multiple days of activity, the ‘average’ day during a given month will not accurately reflect the actual demand for parking. Figure 4-6 depicts the average peak accumulations in the Main Garage for October 2013 for each day of the week as well as for the average day of the month. As shown, the average occupancy during the month is exceeded by the occupancies experienced on an average Tuesday, Wednesday, and Thursday. Thus, basing parking requirements on the ‘average day’ occupancy would likely result in many days (up to 12 days in October, alone) where actual demand exceeded capacity.

Due to the disconnect between peak parking demands and peak month airline passengers, as well as the likelihood that using an average day during a month would underestimate true peak period demands, a ‘design day’ was selected using the method described below.

Figure 4-6
Average Daily Parking Accumulation in the Main Garage, October 2013
 Seattle-Tacoma International Airport

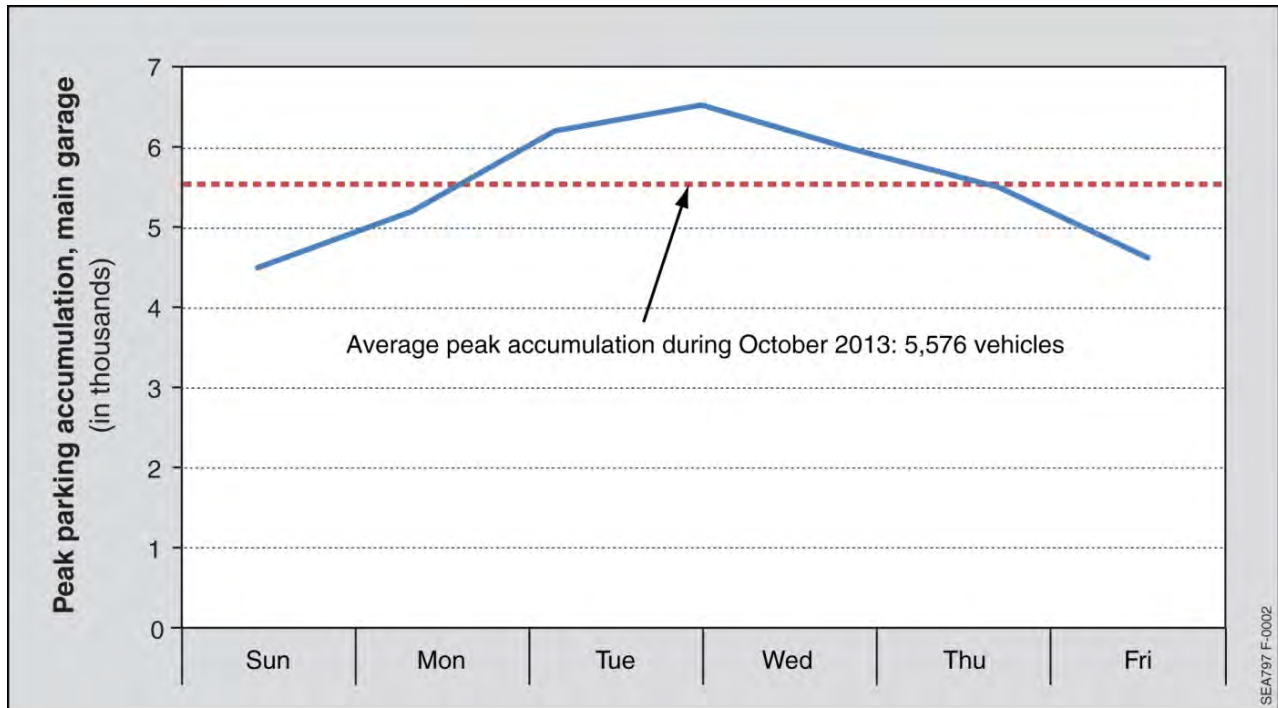

Source: LeighFisher, from data provided by the Port of Seattle.

4.2.6.1 Main Garage

Baseline design day peak occupancy was determined by evaluating the observed midday occupancies for the Main Garage for each day in 2013. Figure 5-7 depicts the observed midday occupancies for the Main Garage for each day in 2013. The observed occupancies, when sorted highest to lowest (regardless of when they occurred during the year), form the S-curve shape shown on Figure 4-7. The 'design day' value was selected by identifying the point on the left side S-curve where the slope transitioned from vertical to horizontal. This point represents the occupancy value exceeded by a very limited number of days (such as holidays), but where using a lower value would mean many additional days would exceed the 'design day'. For comparison, four other days are identified as well:

- Average peak occupancy in October (the peak month for parking accumulation in the Main Garage in 2013)
- Average peak occupancy of Wednesdays in October (Wednesdays are typically the day experiencing the highest accumulations in the Main Garage)
- Average peak occupancy of Wednesdays in April (the month with the highest average Wednesday occupancy)
- Average peak occupancy in July (which reflects accumulations during an average day during the Airport's peak month for airline passengers)

Figure 4-7
Main Garage Peak Occupancies, 2013
 Seattle-Tacoma International Airport

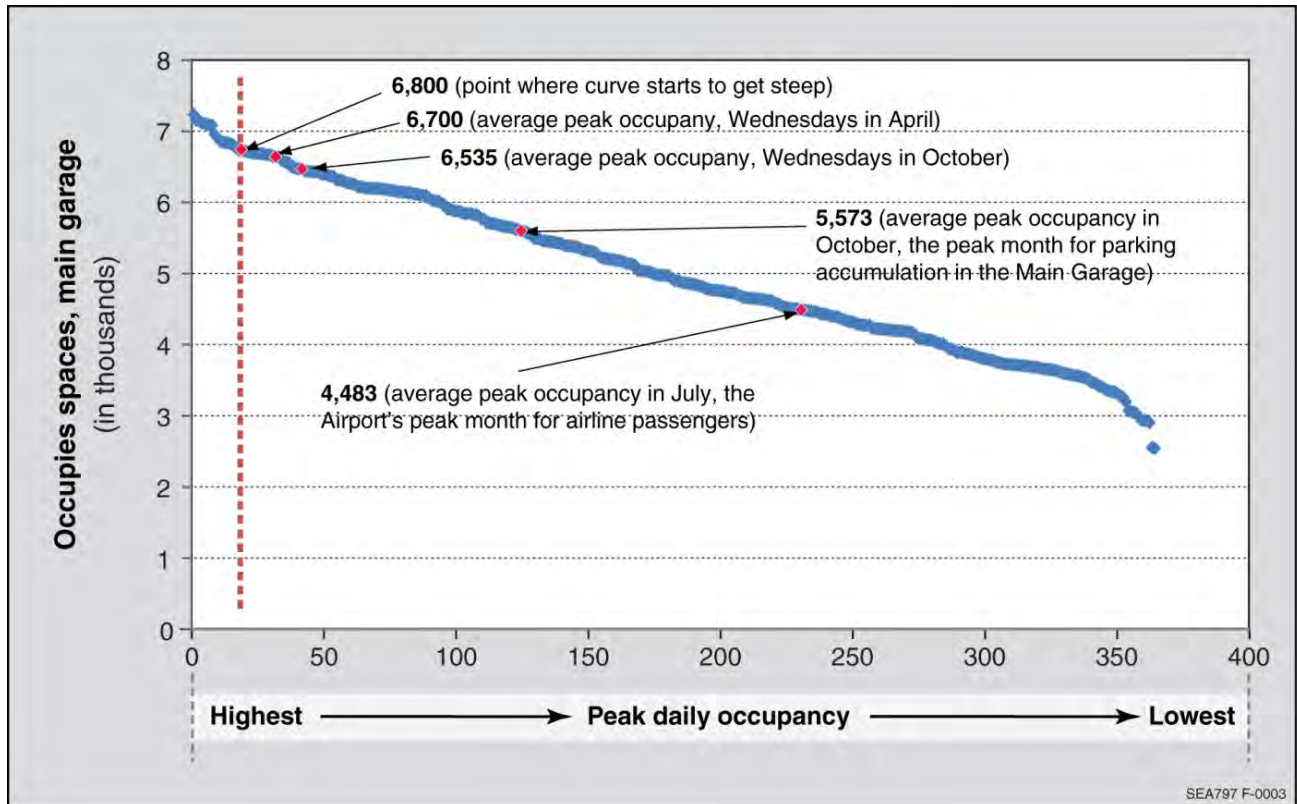

Source: Parking occupancy data provided by the Port of Seattle.

The point identified on the S-Curve, 6,800 occupied parking spaces, was selected as the design day occupancy value for peak accumulations of parking. There are approximately 15 days where peak occupancies were noticeably higher than the selected value whereas a reduction in the selected value would mean there would be many additional days where overnight occupancy exceeded the design day value. This value is also similar to the observed peak accumulations during an average Wednesday in April.

Of the 6,800 occupied spaces, April 2013 transactions-by-duration were evaluated to estimate the number of spaces occupied by short-duration versus long-duration parkers. As shown on Table 4-5, April 2013 transactions-by-duration were adjusted by two factors to estimate the share of occupied spaces during the 'design day' associated with each duration transaction. The first factor, a 'month-to-day' conversion factor, adjusts monthly transactions to reflect transactions occurring during a typical busy day. The second factor, the 'turnover factor', reflects the number of spaces required to accommodate a transaction of certain durations during the typical busy day. For transactions exceeding one day, this factor results in a single daily transaction requiring multiple spaces (i.e., a two-day transaction requires approximately two spaces) to reflect the accumulation of vehicles from prior days. The month-to-day and turnover factors were manually adjusted (using professional judgement

and experience with typical values for these factors) such that the calculated occupied spaces matched the design day value of 6,800 vehicles. As shown, of the 6,800 spaces, approximately 1,300 (approximately 19%) are estimated to be related to parking transactions of less than 24 hours.

Table 4-5
**Estimated Main Garage Occupied Spaces,
 By Parking Duration, April 2013**
 Seattle-Tacoma International Airport

| Parking duration | April 2013 | Design day | Turnover | Occupied spaces |
|------------------|------------|------------|----------|-----------------|
| 0 to 3 hours | 97,721 | 3,370 | 3.50 | 963 |
| 3 to 12 hours | 8,719 | 301 | 2.00 | 150 |
| 12 to 24 hours | 5,712 | 197 | 1.00 | <u>197</u> |
| Subtotal | | | | 1,310 |
| 1 to 2 days | 12,345 | 426 | 0.54 | 794 |
| 2 to 3 days | 11,189 | 386 | 0.35 | 1,106 |
| 3 to 4 days | 7,906 | 273 | 0.26 | 1,054 |
| 4 to 5 days | 4,645 | 160 | 0.21 | 779 |
| 5 to 6 days | 2,298 | 79 | 0.17 | 465 |
| 6 to 7 days | 1,309 | 45 | 0.15 | 310 |
| 7 to 14 days | 2,929 | 101 | 0.11 | 895 |
| Over 14 days | 139 | 5 | 0.06 | <u>87</u> |
| Subtotal | | | | <u>5,490</u> |
| Total | | | | 6,801 |

Note: Main Garage design day demand is to be revised to (a) reflect 2014 activity and (b) identify employee share of design day demand.]

Source: LeighFisher from data provided by the Port of Seattle.

4.2.6.2 Doug Fox Lot

Peak occupancy data is currently unavailable for the Doug Fox Lot. For purposes of quickly estimating preliminary future requirements, visual inspection during LeighFisher on-site meetings in late 2014 indicated the facility was approximately 50% full (800 occupied spaces) during a typical busy day. This value was compared with estimated Doug Fox Lot occupancies prepared by LeighFisher (as part of a separate planning assignment) in 2012 using 2011 transaction and revenue data, which indicated Doug Fox Lot accumulations of approximately 900 vehicles. Given that 2013 Doug Fox Lot transactions were approximately 13% below the volume of 2011 Doug Fox Lot transactions, the estimated 2013 occupancy of 800 vehicles was determined to be reasonable.

4.2.6.3 Off-Airport Parking Facilities

Peak occupancy data is unavailable for the numerous off-Airport parking facilities serving the Airport. For purposes of estimating preliminary future requirements, it was assumed that the facilities were approximately 80% full during typical busy periods, which was based on estimated occupancies observed during a 2006 LeighFisher visual survey of off-Airport parking facilities. Thus, of the

estimated off-Airport capacity of 18,500 spaces, design day demand was estimated to be approximately 15,000 spaces. To validate this assumption, the ratio of off-Airport parking transactions in 2013 versus 2006 (896,000 versus 801,000, a ratio of 1.12) was applied to the estimated 2006 off-Airport parking accumulations (approximately 13,000 vehicles), resulting in an estimated 2013 accumulation of approximately 14,600. Thus, the value of 15,000 was deemed sufficient for purposes of estimating preliminary parking requirements.

4.2.6.3 Summary of Existing Demands

Table 4-6 summarizes existing public parking needs. As shown, the 2014 demands could be accommodated within the available capacity.

**Table 4-6
Existing Public Parking Facility Demands
Seattle-Tacoma International Airport**

| | Design day demand | Parking requirement (a) | Existing capacity |
|---|----------------------|----------------------------|-------------------|
| Short-duration (less than 24 hours) (b) | 1,310 | 1,440 | |
| Long-duration (greater than 24 hours) | | | |
| Main Garage (d) | 5,490 | 6,040 | 12,800 |
| Doug Fox Lot | 800 | 880 | 1,620 |
| Off-Airport facilities | 15,000 | 16,500 | 18,500 |
| Long-duration subtotal | 21,290 | 23,420 | |
| Total | 22,601 | 24,860 | 32,920 |

(a) Includes a 10% circulation factor.

(b) All short-duration parking is assumed to occur in the Main Garage.

Source: LeighFisher, from data provided by the Port of Seattle.

4.2.7 Employee Parking

Airport-wide employee parking is currently provided in the North Employee Parking Lot (NEPL) and to a limited extent in the Main Terminal Garage. The employee parking operation supports the employee parking needs of the airline tenants, the Airport Dining and Retail (ADR) program tenants, Port of Seattle, federal agencies, and other Airport-related services. The employee parking program does not support rental car or other offsite stand-alone facilities (e.g., flight kitchens).

Table 4-7 summarizes the existing employee parking facilities and level of activity associated with airline, ADR, cargo/maintenance, and other airport functions. The key observations related to existing employee parking operations include the following:

- Based on the May 2016 activity report and existing facilities, a total of approximately 6,195 parking stalls are currently in-use for employee parking.

- The existing May 2016 level of activity in the NEPL was reviewed on a day-by-day basis to determine the level of use or occupancy of that facility. As identified in Table 4-7, the NEPL is currently operating at 85% occupancy. There are also a total of 10,006 access cards in use which correlates to 2.4 access cards per parking stall.
- For passenger terminal-related functions, 84% of employees currently park in NEPL and 16% park in the Main Terminal Garage. The employees that park in the Main Terminal Garage generally include Port of Seattle, federal agencies, and a limited number of Airport tenant employees based upon tenant agreements.
- For the cargo and aircraft maintenance functions the majority of the parking needs are currently met on-site (95%). For these on-site facilities, an average of 1.4 parking stalls are provided for every 1,000 SF of cargo or aircraft maintenance facility space.

Table 4-7
Existing Airport-wide Employee Parking Facilities and Use
Seattle-Tacoma International Airport

| Description | Facility (a) Space (sf) | Existing Facilities | | | | | | | |
|-----------------------------------|----------------------------|---------------------|--------------|----------|--------------|----------------|------------|--------------|--------------|
| | | Access Cards (b) | | | | Parking Stalls | | | |
| | | NEPL | MG | Other | Total | NEPL (c) | MG | Other | Total |
| Port of Seattle/Agencies | n.a. | 378 | 1,683 | 0 | 2,061 | 158 | 701 | 0 | 859 |
| Airline Terminal Operations | 1,137,400 | 8,030 | 72 | 0 | 8,102 | 3,346 | 30 | 0 | 3,376 |
| Airport Dining & Retail (d) | 285,793 | 281 | 54 | 0 | 335 | 117 | 23 | 0 | 140 |
| Other/Not Defined (d) | n.a. | 1,158 | 0 | 0 | 1,158 | 435 | 0 | 0 | 435 |
| Terminal Subtotal | 285,793 | 9,847 | 1,809 | 0 | 9,595 | 4,056 | 754 | 0 | 4,810 |
| | | | | | | 84% | 16% | 0% | |
| North Cargo Facilities (c) | 375,700 | 159 | 0 | 0 | 159 | 66 | 0 | 455 | 521 |
| Central Cargo Facilities (e) | 174,300 | 0 | 0 | 0 | 0 | 0 | 0 | 249 | 249 |
| United Maintenance (c) | Unknown | 0 | 0 | 0 | 0 | 0 | 0 | 169 | 169 |
| Alaska Maintenance (c) | 150,000 | 0 | 0 | 0 | 0 | 0 | 0 | 283 | 283 |
| Delta Cargo/Maintenance (c) | 196,000 | 0 | 0 | 0 | 0 | 0 | 0 | 115 | 115 |
| FAA air traffic control tower (c) | n.a. | 0 | 0 | 0 | 0 | 0 | 0 | 48 | 48 |
| Cargo/maintenance Subtotal | 896,000 | 159 | 0 | 0 | 159 | 66 | 0 | 1,319 | 1,385 |
| | | | | | | 5% | 0% | 95% | |
| Totals | | 10,006 | 1,809 | 0 | 9,754 | 4,122 | 754 | 1,319 | 6,195 |
| | | | | | | 67% | 12% | 21% | |

NEPL = North employee parking lot

MG = Main garage

(a) From Aviation/Properties Terminal Space Reconciliation 2016 Settlement Report or Aviation/Property lease records.

(b) From Airport Operations Employee Parking May 2016 billing report.

(c) The number of parking stalls is based upon aerial photographs of existing facilities.

(d) The number of parking stalls was calculated assuming 2.4 access cards per parking stall.

(e) Estimated using an average of one parking stall per 700 SF of cargo building.

Source: Port of Seattle, October 2016.

4.2.8 Rental Car Facilities

In 2011, the Port opened the Rental Car Facility (RCF), located on South 160th Street. This facility provides approximately 1.7 million square feet of space for customer counters, ready/return vehicles, quick-turn-around (QTA) functions, and vehicle storage. The facility was sized to accommodate rental car demands expected to occur when the Airport serves 57 MAP.

The existing facilities appear to be meeting the needs of the rental car operators and customers. Identified deficiencies relate predominately to the shuttle bus operations at the Main Terminal curbsides.

4.2.9 Non-motorized Access

Passengers and employees arriving on foot or bicycle on local streets can safely access the Airport terminal at three locations:

- **Intersection of S 188th St & 28th Ave S.** A shoulder on the west side of 28th Ave S becomes a paved path where the City right of way transitions to a limited access roadway. This path leads to the Gina Marie Lindsay Arrivals Hall at the baggage claim level of the terminal.
- **Intersection of S 182nd St & International Blvd.** A sidewalk at the southwest corner of the intersection runs along the south side of the terminal curb exit lanes curb and leads to the Gina Marie Lindsay Arrivals Hall at the baggage claim level of the terminal.
- **Intersection of S 176th St & International Blvd.** An elevator and stairs at the Sound Transit Kiss & Ride facility at the northeast corner of the intersection leads to a pedestrian bridge that access the Light Rail Station and northeast corner of the Airport parking garage on level 4. A designated walkway along the interior perimeter of the parking garage leads to several pedestrian bridges accessing the mezzanine level of the terminal.

Passengers and employees can also access the terminal with their bicycle using public transit vehicles serving the Airport:

- **Link Light Rail.** The mezzanine level of the terminal can be accessed from the Light Rail station via a designated walkway along the interior perimeter of the parking garage and pedestrian bridges.
- **King County Metro Bus.** Three routes serve the Airport with stops at S 176th St and S 182nd St (Route 156, Route 180 & RapidRide A Line).
- **Sound Transit Express Bus.** Two routes serve the Airport with stops at the south end of the arrivals curb at the baggage claim level of the terminal (Route 560 & Route 574).

4.2.10 Cruise Ship Facilities

Cruise ship facilities at the airport are a seasonal operation from late-April through early-October. During this time, the existing cruise ship operation processes passengers at the north and south ends of the Main Terminal.

Cruise passengers arriving from the waterfront are dropped off in the North Charter Bus Lot (NCBL) for those airlines with check-in functions located in the north half of the Main Terminal. Cruise passengers arriving from the waterfront are dropped off in the South GT (Ground Transportation) Lot for those airlines with check-in functions located in the south half of the Main Terminal. Facilities for boarding pass and bag drop are located at the NCBL and South GT for those airlines that choose to staff these areas. Passengers arriving from the waterfront also have the ability to print their boarding pass inside the Main Terminal (at either a Port Common Use Self-Service (CUSS) kiosk for certain airlines, or at an airline proprietary kiosk), and drop bags where their airline is located.

Passengers who fly into Sea-Tac and depart for the waterfront board buses at the South GT Lot, unless they make alternate arrangements for transportation to the waterfront. Many passengers who make alternate arrangements to get to the waterfront have a “land tour package” as part of their itinerary and board their cruise ship on a different day.

As an alternative to check-in at the airport, some cruise ship lines are working with a third party service, like Bags Inc., that provides a fee-based service where passengers can print their boarding pass and check their bag on the cruise ship.

In 2017 the cruise ship operation in the NCBL will be permanently displaced in the north due to construction of a holdroom for passengers bused to remote gates, and at the South GT Lot due to construction of the IAF (International Arrivals Facility). Alternate facilities and operations have been developed by Airport Operations to accommodate this impact; however, this is not intended to be a long-term solution.

4.3 Desired Ground Access and Parking Characteristics and Planning Assumptions

The facilities requirements presented in this section generally reflect the goal to provide facilities that operate at Level of Service (LOS) C or better during the peak hour. This goal reflects the potentially severe consequences of delay for passengers traveling to the Airport, such as customers missing flights. For the purposes of defining LOS associated with ground access facilities, we have used North American highway LOS standards from the Transportation Research Board’s Highway Capacity Manual, using letters A through F, with A being the best and F being the worst. The following summarize these levels of service:

- **LOS A – free flow.** At LOS A, traffic flows at or above the posted speed limit and motorists have complete mobility between lanes.

- **LOS B – reasonably free flow.** At LOS B, traffic maintains LOS A speeds but maneuverability within the traffic stream is slightly restricted.
- **LOS C – stable flow.** At LOS C traffic experiences near free flow but the ability to maneuver through lanes is noticeably restricted and lane changes require more driver awareness.
- **LOS D – approaching unstable flow.** At LOS D, traffic speeds slightly decrease as traffic volume slightly increases; the freedom to maneuver within the traffic stream is much more limited and driver comfort levels decrease.
- **LOS E – unstable flow.** At LOS E, roadway facilities are operating at capacity; traffic flow becomes irregular and speed varies rapidly because there are virtually no usable gaps to maneuver in the traffic stream and speeds rarely reach the posted limit.
- **LOS F – forced or breakdown flow.** At LOS F, every vehicle moves in lockstep with the vehicle in front of it, with frequent slowing required; travel time cannot be predicted, and demand generally exceeds capacity.

For parking facilities, LOS C represents conditions where demand is 90% or less of capacity, recognizing the increasing difficulty of finding available spaces until higher occupancies.

4.4 Ground Access and Parking Facility Requirements

This section presents the requirements for those ground access and parking facilities that will most influence the development of alternatives. The approaches and key assumptions in estimating the requirements are described in the following paragraphs.

4.4.1 Off-Airport Access Roadways

This section summarizes the projected regional traffic conditions at 2035, near the end of the SAMP planning period. Figure 4-8 depicts the regional model V/C ratios for key roadways in the Airport vicinity. As shown, in addition to further degradation of conditions on the regional facilities experiencing congestion in 2010 (such as the I-5/I-405 interchange and southbound I-5), SR 509 and SR 518 are expected to experience V/Cs exceeding 0.8 (representing LOS E). However, conditions on I-405 are expected to improve.

4.4.2 On-Airport Access Roadways

As described in Section 4.2.1, the on-Airport roadway system includes the North Airport Expressway (NAE) that provides access to the curbsides, commercial ground transportation areas, main garage, and Air Cargo Road. All of these elements were evaluated by Port staff using the Sea-Tac Airport travel demand forecasting model for the afternoon peak hour, for the following scenarios:

- 2010 (see Section 4.2.1). This model assumed the Airport served approximately 31.5 MAP.

- 2025. In addition to the existing on-Airport roadways, this scenario assumes that an interim phased of South Access has been implemented. This model assumed the Airport served approximately 53.6 MAP.
- 2035. In addition to the existing on-Airport roadways, this scenario assumes that the future South Airport Expressway has been implemented providing a direct connection between the Airport terminal area and a future extension of SR 509. This model assumed the Airport served approximately 66.0 MAP.

To estimate future requirements, peak hour volumes from the model runs described above were adjusted as follows:

- For PAL 1 (2018): 2025 model, multiplied by 0.84 (ratio of 44.8 MAP to 53.6 MAP)
- For PAL 2 (2023): 2025 model, multiplied by 0.97 (ratio of 51.8 MAP to 53.6 MAP)
- For PAL 3 (2028): 2025 model, multiplied by 1.10 (ratio of 58.9 MAP to 53.6 MAP)
- For PAL 4 (2034): 2035 model, multiplied by 0.99 (ratio of 65.6 MAP to 66.0 MAP)

Figure 4-9 depicts key on-Airport access roadways described in Section 4.2, but also includes the future development of South Access and the South Airport Expressway. Due the development of the South Access and the South Airport Expressway, the regional model predicts that by 2035, approximately 77% of peak hour Airport traffic will access the Airport to and from the north via the North Airport Expressway (compared with 87% in 2010). As shown on Table 4-8 and 4-9, by PAL 2, additional capacity is required on the southbound North Airport Expressway and the southbound direction of the interim South Access roadway. By PAL 3, additional capacity is required on both inbound ramps from SR 518 as well as the outbound ramp to eastbound SR 518. By PAL 4, the South Airport Expressway will require additional capacity.

Figure 4-8
2035 Regional Traffic Conditions
Seattle-Tacoma International Airport

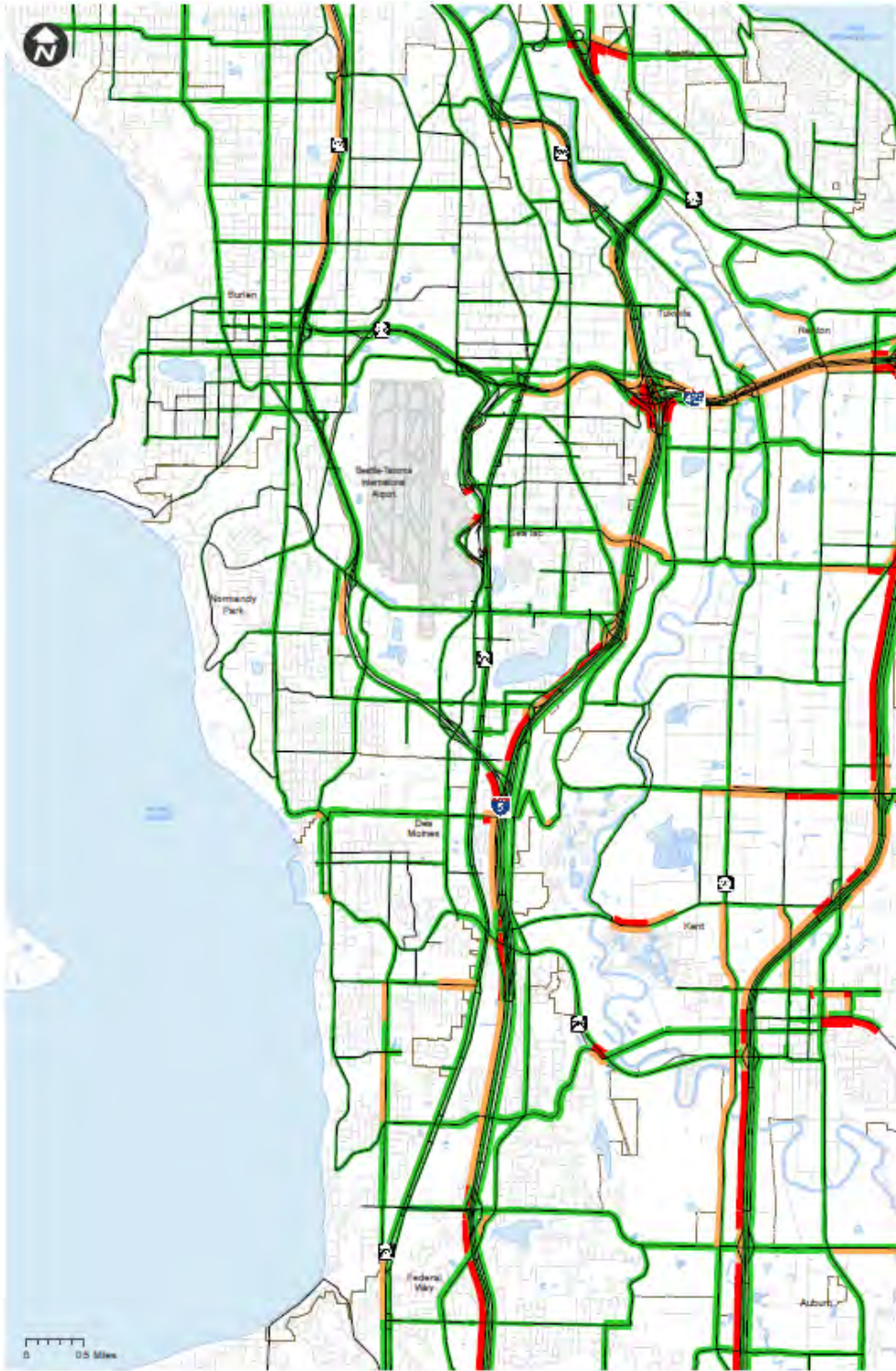

VC Ratio - 2035 SAE Existing Terminal

DRAFT FIGURE

Source: Port of Seattle, 2017.

Figure 4-9
On-Airport Access Roadways with Future South Access and South Airport Expressway
 Seattle-Tacoma International Airport

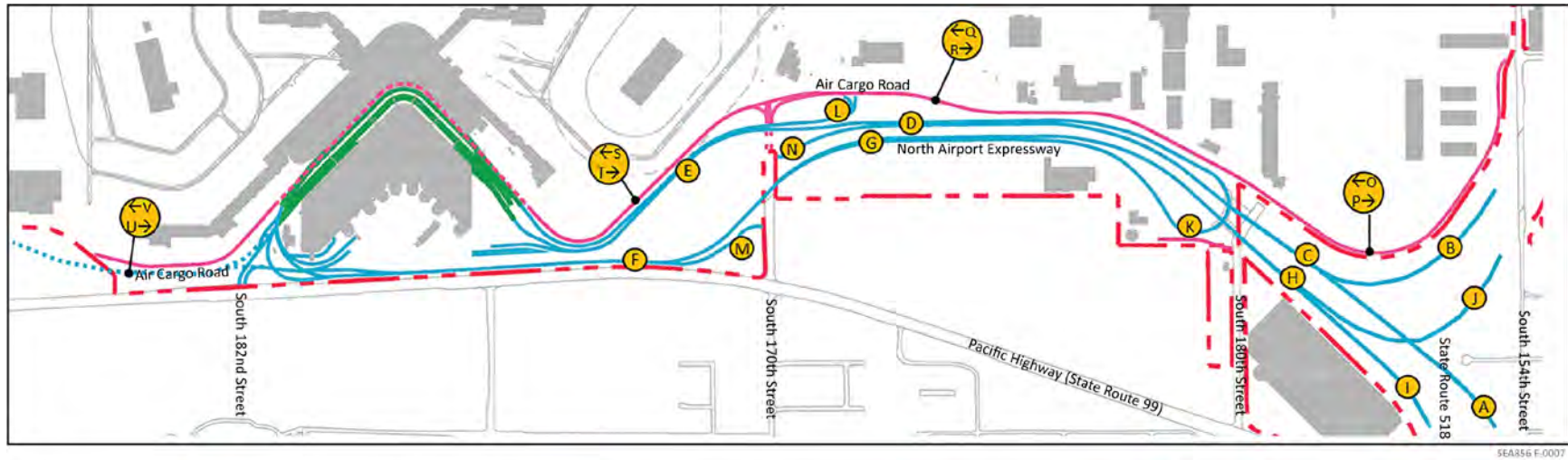

SEA856 F-0007

- Airport property line
- Service road tunnel
- Curbside
- Access and circulation
- Service roads
- Airport buildings
- Roadway link identifier

Note: Roadway link identifiers are keyed to data presented in Table 5-8.

Source: InterVISTAS, from background map provided by Shen Consulting.

Table 4-8
Future On-Airport Access Roadway Volumes and Lanes Required to Achieve Los C or Better (PALS 1 and 2)
 Seattle-Tacoma International Airport

| Link identifier | Facility | Existing (2014) | | | | | | | PAL 1 | | | | PAL 2 | | | |
|-----------------|--|---------------------|-----------------------------|----------------------|-------------------|-------------------|-------|----------|------------|-----------------------|----------------------|----------------------------------|------------|-----------------------|----------------------|----------------------------------|
| | | Assumed speed (mph) | Basic capacity per lane (a) | Heavy vehicle factor | Population factor | Capacity per lane | Lanes | Capacity | Volume (b) | Volume/capacity ratio | Level of service (a) | Lanes to achieve LOS C or better | Volume (b) | Volume/capacity ratio | Level of service (c) | Lanes to achieve LOS C or better |
| A | Ramp from SR 518, westbound | 50 | 2,000 | 0.95 | 0.85 | 1,620 | 2 | 3,240 | 1,828 | 0.56 | C | 2 | 2,114 | 0.65 | D | 3 |
| B | Ramp from SR 518, eastbound | 40 | 1,750 | 0.95 | 0.85 | 1,410 | 1 | 1,410 | 682 | 0.48 | C | 1 | 789 | 0.56 | C | 1 |
| C | North Airport Expressway, southbound, prior to return-to-terminal ramp | 40 | 1,750 | 0.95 | 0.85 | 1,410 | 3 | 4,230 | 2,511 | 0.59 | C | 3 | 2,904 | 0.69 | D | 4 |
| D | North Airport Expressway, southbound, after return-to-terminal ramp | 40 | 1,750 | 0.95 | 0.85 | 1,410 | 3 | 4,230 | 2,857 | 0.68 | D | 4 | 3,304 | 0.78 | D | 4 |
| E | Terminal area entrance | 30 | 1,450 | 0.95 | 0.85 | 1,170 | 4 | 4,680 | 2,798 | 0.60 | C | 4 | 3,236 | 0.69 | D | 5 |
| F | Terminal area exit to north | 40 | 1,750 | 0.95 | 0.85 | 1,410 | 4 | 5,640 | 2,557 | 0.45 | C | 4 | 2,957 | 0.52 | C | 4 |
| G | North Airport Expressway, northbound, prior to return-to-terminal ramp | 40 | 1,750 | 0.95 | 0.85 | 1,410 | 5 | 7,050 | 2,308 | 0.33 | B | 5 | 2,669 | 0.38 | B | 5 |
| H | North Airport Expressway, northbound, after return-to-terminal ramp | 40 | 1,750 | 0.95 | 0.85 | 1,410 | 3 | 4,230 | 1,962 | 0.46 | C | 3 | 2,269 | 0.54 | C | 3 |
| I | Ramp to SR 518, eastbound | 50 | 2,000 | 0.95 | 0.85 | 1,620 | 2 | 3,240 | 1,750 | 0.54 | C | 2 | 2,023 | 0.62 | D | 3 |
| J | Ramp to SR 518, westbound | 45 | 1,900 | 0.95 | 0.85 | 1,530 | 2 | 3,060 | 483 | 0.16 | A | 2 | 559 | 0.18 | A | 2 |
| K | Return-to-terminal ramp | 25 | 1,250 | 0.95 | 0.85 | 1,010 | 2 | 2,020 | 346 | 0.17 | A | 2 | 400 | 0.20 | A | 2 |
| L | On-ramp from Air Cargo Road | 25 | 1,250 | 0.8 | 1.0 | 1,000 | 2 | 2,000 | 253 | 0.13 | A | 2 | 292 | 0.15 | A | 2 |
| M | Northbound exit to South 170th Street | 25 | 1,250 | 0.8 | 1.0 | 1,000 | 1 | 1,000 | 248 | 0.25 | A | 1 | 287 | 0.29 | B | 1 |
| N | Southbound exit to South 170th Street | 25 | 1,250 | 1.0 | 1.0 | 1,250 | 1 | 1,250 | 311 | 0.25 | A | 1 | 360 | 0.29 | B | 1 |
| O | Air Cargo Road, southbound, north of South 160th Street | 35 | 1,600 | 0.75 | 1.0 | 1,200 | 2 | 2,400 | 251 | 0.10 | A (c) | 2 | 290 | 0.12 | A (c) | 2 |
| P | Air Cargo Road, northbound, north of South 160th Street | 35 | 1,600 | 0.75 | 1.0 | 1,200 | 2 | 2,400 | 162 | 0.07 | A (c) | 2 | 188 | 0.08 | A (c) | 2 |
| Q | Air Cargo Road, southbound, north of South 170th Street | 35 | 1,600 | 0.75 | 1.0 | 1,200 | 1 | 1,200 | 141 | 0.12 | A (c) | 1 | 162 | 0.14 | A (c) | 1 |
| R | Air Cargo Road, northbound, north of South 170th Street | 35 | 1,600 | 0.75 | 1.0 | 1,200 | 1 | 1,200 | 56 | 0.05 | A (c) | 1 | 65 | 0.05 | A (c) | 1 |
| S | Air Cargo Road, southbound, south of South 170th Street | 35 | 1,600 | 0.75 | 1.0 | 1,200 | 1 | 1,200 | -- | 0.00 | A (c) | 1 | -- | 0.00 | A (c) | 1 |
| T | Air Cargo Road, northbound, south of South 170th Street | 35 | 1,600 | 0.75 | 1.0 | 1,200 | 1 | 1,200 | -- | 0.00 | A (c) | 1 | -- | 0.00 | A (c) | 1 |
| U | Interim South Access, northbound (d) | 25 | 1,250 | 0.95 | 0.85 | 1,010 | 1 | 1,010 | 454 | 0.45 | C (c) | 1 | 525 | 0.52 | C (c) | 1 |
| V | Interim South Access, southbound (d) | 25 | 1,250 | 0.95 | 0.85 | 1,010 | 1 | 1,010 | 742 | 0.73 | D (c) | 2 | 858 | 0.85 | E (c) | 2 |

(a) Based on Airport Cooperative Research Program (ACRP) Report 40, Table 4-1.
 (b) Based on volumes provided by the Port of Seattle.
 (c) Traffic conditions also impacted by intersections and/or truck turning movements.
 (d) Assumes interim South Access roadways are in-place by PAL 1.

Source: InterVISTAS, from traffic volume data provided by the Port of Seattle.

Table 4-9
Future On-Airport Access Roadway Volumes and Lanes Required to Achieve Los C or Better (PALS 3 and 4)
 Seattle-Tacoma International Airport

| Link identifier | Facility | Assumed speed (mph) | Lanes | Capacity (a) | PAL 3 | | | | PAL 4 | | | |
|-----------------|--|---------------------|-------|--------------|------------|-----------------------|----------------------|----------------------------------|------------|-----------------------|----------------------|----------------------------------|
| | | | | | Volume (b) | Volume/capacity ratio | Level of service (c) | Lanes to achieve LOS C or better | Volume (b) | Volume/capacity ratio | Level of service (c) | Lanes to achieve LOS C or better |
| A | Ramp from SR 518, westbound | 50 | 2 | 3,240 | 2,404 | 0.74 | D | 3 | 2,517 | 0.78 | D | 3 |
| B | Ramp from SR 518, eastbound | 40 | 1 | 1,410 | 897 | 0.64 | D | 2 | 974 | 0.69 | D | 2 |
| C | North Airport Expressway, southbound, prior to return-to-terminal ramp | 40 | 3 | 4,230 | 3,301 | 0.78 | D | 4 | 3,490 | 0.83 | E | 5 |
| D | North Airport Expressway, southbound, after return-to-terminal ramp | 40 | 3 | 4,230 | 3,756 | 0.89 | E | 5 | 4,064 | 0.96 | E | 5 |
| E | Terminal area entrance | 30 | 4 | 4,680 | 3,679 | 0.79 | D | 6 | 4,011 | 0.86 | E | 6 |
| F | Terminal area exit to north | 40 | 4 | 5,640 | 3,361 | 0.60 | C | 4 | 3,874 | 0.69 | D | 5 |
| G | North Airport Expressway, northbound, prior to return-to-terminal ramp | 40 | 5 | 7,050 | 3,035 | 0.43 | C | 5 | 3,396 | 0.48 | C | 5 |
| H | North Airport Expressway, northbound, after return-to-terminal ramp | 40 | 3 | 4,230 | 2,580 | 0.61 | D | 4 | 2,822 | 0.67 | D | 4 |
| I | Ramp to SR 518, eastbound | 50 | 2 | 3,240 | 2,300 | 0.71 | D | 3 | 2,452 | 0.76 | D | 3 |
| J | Ramp to SR 518, westbound | 45 | 2 | 3,060 | 636 | 0.21 | A | 2 | 723 | 0.24 | A | 2 |
| K | Return-to-terminal ramp | 25 | 2 | 2,020 | 455 | 0.23 | A | 2 | 574 | 0.28 | B | 2 |
| L | On-ramp from Air Cargo Road | 25 | 2 | 2,000 | 332 | 0.17 | A | 2 | 377 | 0.19 | A | 2 |
| M | Northbound exit to South 170th Street | 25 | 1 | 1,000 | 327 | 0.33 | B | 1 | 478 | 0.48 | C | 1 |
| N | Southbound exit to South 170th Street | 25 | 1 | 1,250 | 409 | 0.33 | B | 1 | 431 | 0.34 | B | 1 |
| O | Air Cargo Road, southbound, north of South 160th Street | 35 | 2 | 2,400 | 330 | 0.14 | A (d) | 2 | 345 | 0.14 | A (d) | 2 |
| P | Air Cargo Road, northbound, north of South 160th Street | 35 | 2 | 2,400 | 213 | 0.09 | A (d) | 2 | 271 | 0.11 | A (d) | 2 |
| Q | Air Cargo Road, southbound, north of South 170th Street | 35 | 1 | 1,200 | 185 | 0.15 | A (d) | 1 | 217 | 0.18 | A (d) | 1 |
| R | Air Cargo Road, northbound, north of South 170th Street | 35 | 1 | 1,200 | 74 | 0.06 | A (d) | 1 | 109 | 0.09 | A (d) | 1 |
| S | Air Cargo Road, southbound, south of South 170th Street | 35 | 1 | 1,200 | -- | 0.00 | A (d) | 1 | -- | 0.00 | A (d) | 1 |
| T | Air Cargo Road, northbound, south of South 170th Street | 35 | 1 | 1,200 | -- | 0.00 | A (d) | 1 | -- | 0.00 | A (d) | 1 |
| U | Interim South Access, northbound | 25 | 1 | 1,010 | 597 | 0.59 | C (d) | 1 | -- | -- | -- | -- |
| V | Interim South Access, southbound | 25 | 1 | 1,010 | 975 | 0.97 | E (d) | 2 | -- | -- | -- | -- |
| U | South Airport Expressway, northbound | 40 | 1 | 1,410 | -- | -- | -- | -- | 966 | 0.68 | D (d) | 2 |
| V | South Airport Expressway, southbound | 40 | 1 | 1,410 | -- | -- | -- | -- | 1,149 | 0.81 | E (d) | 2 |

(a) See Table 4-8

(b) Based on volumes provided by the Port of Seattle.

(c) Based on Airport Cooperative Research Program (ACRP) Report 40, Table 4-1.

(d) Traffic conditions also impacted by intersections and/or truck turning movements.

Source: InterVISTAS, from traffic volume data provided by the Port of Seattle, 2017.

4.4.3 Terminal-area Circulation Roadways

Figure 4-10 depicts four terminal-area circulation roadways identified as requiring additional capacity during the planning period.

Figure 4-10
Key Terminal-Area Roadways
Seattle-Tacoma International Airport



Source: InterVISTAS Inc., 2016.

Table 4-10 summarizes the existing lane configuration, assumed capacity, and hourly volumes for the four selected terminal-area roadways assuming a one-terminal scenario. Table 4-11 summarizes the calculated volume/capacity ratio and corresponding level-of-service.

Table 4-10
Existing and Future Peak Hour Volumes, Selected Terminal-Area Roadways, One-Terminal Scenario
 Seattle-Tacoma International Airport

| | Number of lanes | Assumed capacity (vehicles per hour) (a) | Design hour volumes | | | | |
|--|-----------------|--|----------------------------|------------|------------|------------|------------|
| | | | 2014 | PAL 1 2019 | PAL 2 2024 | PAL 3 2029 | PAL 4 2034 |
| | | | A. Approach to Lower Drive | 2 | 2,500 | 2,110 | 2,640 |
| B. Approach to Upper Drive | 2 | 2,500 | 1,240 | 1,400 | 1,470 | 1,540 | 1,690 |
| C. Exit from Upper Drive to North Airport Expressway | 1 | 1,450 | 1,240 | 1,400 | 1,470 | 1,540 | 1,690 |
| D. Exit from Lower Drive to North Airport Expressway | 2 | 2,900 | 1,210 | 1,550 | 1,660 | 1,790 | 2,110 |

(a) Based on Airport Cooperative Research Program Report 40, Table 4-1.

Source: LeighFisher, 2015, from data provided by the Port of Seattle.

Table 4-11
Volume/Capacity Ratios and Corresponding Level of Service, Selected Terminal-Area Roadways, One-Terminal Scenario
 Seattle-Tacoma International Airport

| | 2014 | | PAL 1 | | PAL 2 | | PAL 3 | | PAL 4 | |
|--|---------------------|-----|---------------------|-----|---------------------|-----|---------------------|-----|---------------------|-----|
| | Volume/capacity (a) | LOS | Volume/capacity (a) | LOS | Volume/capacity (a) | LOS | Volume/capacity (a) | LOS | Volume/capacity (a) | LOS |
| A. Approach to Lower Drive | 0.84 | E | 1.06 | F | 1.13 | F | 1.29 | F | 1.44 | F |
| B. Approach to Upper Drive | 0.50 | C | 0.56 | C | 0.59 | C | 0.62 | D | 0.68 | D |
| C. Exit from Upper Drive to North Airport Expressway | 0.86 | E | 0.97 | E | 1.01 | F | 1.06 | F | 1.17 | F |
| D. Exit from Lower Drive to North Airport Expressway | 0.42 | C | 0.53 | C | 0.57 | C | 0.65 | D | 0.73 | D |

LOS = level of service

Note: LOS values are based on Airport Cooperative Research Program Report 40, Table 4-1.

(a) See Table for volume and capacity values.

Source: LeighFisher, 2015.

As shown in Table 4-11, the approaches to the Lower Drive and the exit from the Upper Drive operate at a poor LOS today and the LOS is expected to deteriorate in the future. The approaches to the Upper Drive and exit from the Lower Drive are expected to operate at LOS C through PAL 3 and at LOS D by

PAL 4. Table 4-12 summarizes the number of lanes required to achieve LOS C or better for each of the key roadway links.

Table 4-12
Lanes Required to Address Terminal-Area Roadway Deficiencies, One-Terminal Scenario
 Seattle-Tacoma International Airport

| | 2014 | | PAL 1 | | PAL 2 | | PAL 3 | | PAL 4 | | |
|--|----------------|------------------|--------------------|--------------------|--------------------|--------------------|--------------------|--------------------|-------|---|-------|
| | Existing lanes | Baseline LOS (a) | Total lanes | Total lanes | Total lanes | Total lanes | Total lanes | Total lanes | | | |
| | | | required for LOS C | required for LOS C | required for LOS C | required for LOS C | required for LOS C | required for LOS C | | | |
| A. Approach to Lower Drive | 2 | E | 3 | F | 4 | F | 4 | F | 5 (b) | F | 5 (b) |
| B. Approach to Upper Drive | 2 | C | 2 | C | 2 | C | 2 | D | 3 | D | 3 |
| C. Exit from Upper Drive to North Airport Expressway | 1 | E | 2 | E | 2 | F | 2 | F | 2 | F | 2 |
| D. Exit from Lower Drive to North Airport Expressway | 2 | C | 2 | C | 2 | C | 2 | D | 3 | D | 3 |

LOS = level of service

(a) See Table 4-11.

(b) LOS D can be achieved with 4 total lanes.

Source: LeighFisher, 2015.

Table 4-13 summarizes the incremental number of lanes required on each of the four key roadways by each planning horizon.

Table 4-13
Terminal-Area Circulation Roadway Requirements
Seattle-Tacoma International Airport

| Roadway segment (a) | Existing lanes | Period-over-period additional lanes required to achieve LOS C | | | | |
|--|----------------|---|------------|------------|------------|------------|
| | | 2014 | PAL 1 2019 | PAL 2 2024 | PAL 3 2029 | PAL 4 2034 |
| | | A. Approach to Lower Drive | 2 | 1 | 1 | 0 |
| B. Approach to Upper Drive | 2 | 0 | 0 | 0 | 1 | 0 |
| C. Exit from Upper Drive to North Airport Expressway | 1 | 1 | 0 | 0 | 0 | 0 |
| D. Exit from Lower Drive to North Airport Expressway | 2 | 0 | 0 | 0 | 1 | 1 |

LOS = level of service

(a) The locations for roadway segments are identified on Figure 4.

(b) LOS D can be achieved if no additional lane is provided in PAL 3.

Source: InterVISTAS Inc., 2016.

Each roadway requires at least one additional lane prior to the end of the planning period. Though the approach to the Lower Drive requires a total of 5 lanes by PAL 3, there may be insufficient real estate to meet that requirement. In the event five lanes are infeasible, LOS D can be achieved through PAL 4 with a total of 4 lanes.

4.4.4 Curbside Roadways

This section summarizes the existing and future activity levels expected to use curbside facilities, curbside facility requirements, and alternatives for meeting the future activity levels at an acceptable level of service.

For planning purposes, curbside facility requirements are established to provide level-of-service (LOS) C or better during the ‘design hour’ identified for the facility. LOS C, as defined in *Airport Cooperative Research Program (ACRP) Report 40, Airport Curbside and Terminal Area Roadway Operations*, is based on (a) the curbside utilization, which indicates the ability of a roadway to accommodate existing or projected requirements for vehicles loading or unloading at the curbside by comparing the required length of loading or unloading area with the available curbside length and (b) the volume to capacity (v/c) ratio of the curbside roadway, with the poorest LOS of the two governing. Table 4-14 summarizes the curbside utilization ratio associated with LOS A through F. Additionally, because the curbside utilization value impacts the curbside roadway capacity value used in the v/c ratio, Table 4-14 also provides the assumed curbside roadway capacity associated with each curbside utilization LOS threshold.

**Table 4-14
Curbside Utilization Level of Service Ratios**

| | Airport curbside levels of service | | | | | |
|---|------------------------------------|-------|-------|-------|-------|-------------|
| | A | B | C | D | E | F |
| Curbside utilization ratio (<i>a</i>) | 0.90 | 1.10 | 1.30 | 1.70 | 2.00 | > 2.00 |
| Curbside roadway capacity (vehicles per hour) | | | | | | |
| Upper Drive (4 lanes) | 2,830 | 2,790 | 2,680 | 2,220 | 1,800 | Up to 1,800 |
| Lower Drive (5 lanes) | 3,400 | 3,280 | 3,100 | 2,710 | 2,400 | Up to 2,400 |

(a) The ratio between the calculated curbside demand and the available effective curbside length.

Source: Airport Cooperative Research Program Report 40, Table 5-2.

Table 4-15 summarizes the v/c ratio associates with each curbside roadway LOS threshold.

**Table 4-15
Curbside Roadway Level of Service Ratios**

| | Airport curbside levels of service | | | | | |
|--|------------------------------------|------|------|------|------|-------|
| | A | B | C | D | E | F |
| Maximum through lane volume/capacity ratio | 0.25 | 0.40 | 0.60 | 0.80 | 1.00 | >1.00 |

Source: Airport Cooperative Research Program Report 40, Table 5-2.

Figure 4-11 depicts representative curbside conditions associated with each LOS.

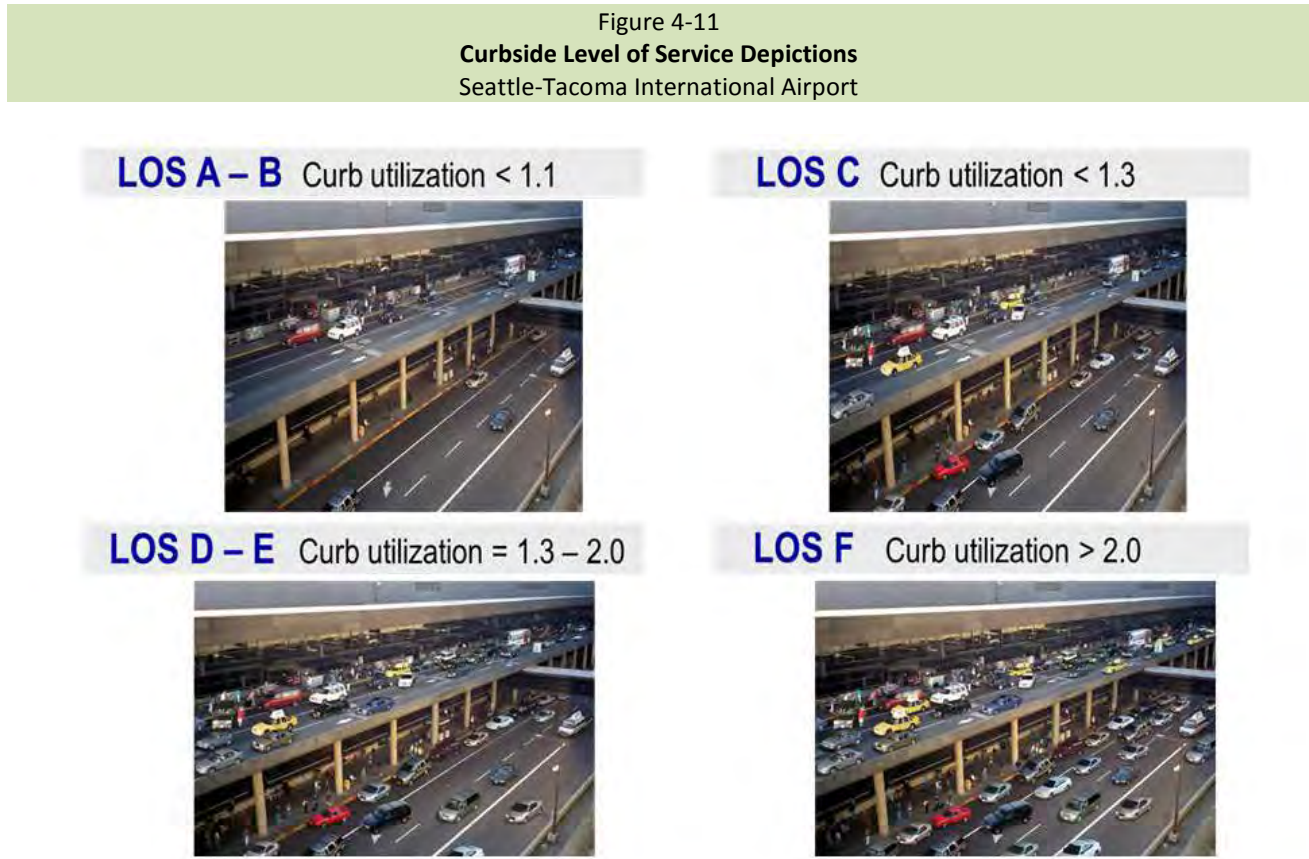

Source: InterVISTAS Inc., 2016.

The goal of the curbside facility requirements is to identify, for each planning activity level, the number of loading and/or unloading vehicles requiring accommodation during the 'design hour' for each curbside. For curbsides where vehicles park in a linear fashion, such as at the Airport, curbside requirements are also typically provided in linear feet of curbside frontage parallel to a functioning terminal building and assume some amount of double-parking.

Key data used in developing the curbside requirements include:

- Design hour traffic volumes using Upper and Lower Level curbsides
- Vehicle classification distribution, as provided by 2009 surveys conducted by the Airport
- Peak period passenger volumes, as provided by the passenger flow model
- Average dwell times of vehicles stopping at the curb to pick up or drop off passengers
- Typical length of curb occupied by a stopped vehicle, by mode. This distance includes the vehicle length as well as distance in front and in back to allow for maneuvering as the vehicle exits or enters the traffic stream.

4.4.4.1 Methodology

Curbside facility requirements are calculated by one of two methods depending on the operating characteristics of the mode.

- **Vehicles operating on an on-demand basis** (e.g., private vehicles, taxicabs, for hire vehicles, selected courtesy shuttles, and 'other' vehicles such as delivery vans). Design hour vehicle volumes are combined with the assumed dwell times to determine the average number of vehicles simultaneously picking up and/or dropping off passengers. This average value is then adjusted to reflect the 95th percentile number of vehicles expected to simultaneously pick up and/or drop off passengers during the design hour. This 95th percentile value is then multiplied by the average vehicle length to estimate the length of occupied linear curb, which is then divided by 1.3 to account for a level of double-parking consistent with industry standards for level-of-service C for curbside roadways.
- **Vehicles operating on a scheduled basis** (e.g., airporters, rental car shuttles, selected courtesy shuttles, and public transit). Consistent with current operations, these vehicles are assumed to require dedicated space on the curbside. For each curbside zone, vehicle volumes are combined with the assumed dwell times to determine the average number of vehicles simultaneously picking up and/or dropping off passengers. Due to the scheduled nature of these vehicles, there is a low likelihood of peaking within the hour. Thus, requirements reflect the average number of vehicles expected to be loading and/or unloading simultaneously.

4.4.4.2 Dwell Times and Vehicle Lengths

Table 4-15 summarizes the dwell times and vehicle lengths assumed for each mode. The dwell time values are based on typical values suggested in *ACRP Report 40* as well as values used in prior curbside analyses at the Airport. These values, however, are not necessarily representative of existing conditions and current dwell times are understood to exceed the values shown on Table 4-16. However, since curbside dwell times are directly related to the Airport's practices regarding enforcement of curbside policies, it is assumed for planning purposes that the values shown in Table 4-16 can be achieved. The vehicle lengths are those typically used in the industry and represent the distance between the front of a vehicle and the front of the vehicle immediately in front or behind. The future curbside requirements assume that these values remain unchanged through the planning period.

Table 4-16
Curbside Vehicle Dwell Times and Lengths
 Seattle-Tacoma International Airport

| | Dwell time (minutes) | | Vehicle length (feet) |
|---|-----------------------|---------------------|--------------------------|
| | Passenger drop-off | Passenger pickup | |
| Private vehicles (a) | 2.0 | 2.0 | 25 |
| Taxicabs (b) | 2.0 | n/a | 25 |
| Limousines (b) | 2.0 | n/a | 25 |
| Shared ride vans (b) | 2.5 | 4.0 | 30 |
| Scheduled buses / vans (airporters) (c) | 5.0 | n/a | Up to 60 |
| Rental car shuttle (d) | 4.0 | 4.0 | 60 |
| Public transit | 2.0 | | 60 |
| Other (service vehicle, police car, etc.) | 3.0 | 3.0 | 30 |

- (a) Includes rental cars using the curbsides.
 (b) Vehicle picks up passengers in the commercial vehicle lanes in the Main Garage.
 (c) Depending on vehicle size, vehicle picks up passengers in the commercial vehicle lanes in the Main Garage or in the South Ground Transportation Lot.
 (d) Vehicle picks up and drops off passengers on the Lower Level.

Source: LeighFisher, August 2015.

4.4.4.3 Vehicle Classification

Table 4-17 presents the assumed vehicle classification percentages for vehicles dropping off enplaning passengers on the Upper Drive, based on visual surveys conducted as part of previous curbside planning efforts.

Table 4-17
Curbside Vehicle Classification, Upper Drive
 Seattle-Tacoma International Airport

| | Share of vehicles using roadway |
|-----------------------------------|------------------------------------|
| Private vehicles | 77% |
| Taxicabs | 11 |
| Limousines | 8 |
| Shared ride vans | 2 |
| Scheduled vans/buses (Airporters) | 1 |
| Charter buses | < 1 |
| Other vehicles | <u>1</u> |
| Total | 100% |

Source: LeighFisher, based on traffic surveys conducted in October 2009 during morning and midday peak periods.

On the Lower Drive, vehicles using the curbsides are limited to private vehicles, the consolidated rental car shuttle, and public transit buses. Given that the rental car shuttle and public transit buses operate on fixed schedules with known hourly volumes, vehicle classification surveys were not conducted.

4.4.4.4 Design Hour Volumes

Table 4-18 and Table 4-19 summarize the design hour curbside volumes for the Upper Drive and Lower Drive, respectively, for baseline (2014) conditions through PAL 4. These volumes are based on (a) 2014 traffic counts conducted in August and September 2014 and (b) vehicle classifications provided in Table 4-17. Volumes are escalated in direct proportion to expected growth in peak period passengers during the Airport’s peak month. As such, the Upper Drive peak, which is predominately linked to enplaning passenger volumes and occurs in the early morning, is assumed to grow at the same rate as the peak 60-minute period for enplaning passengers departing between 6 a.m. and 9 a.m.: a growth factor of 1.42 from 2014 to PAL 4. The Lower Drive peak, which is predominately linked to deplaning passenger volumes and occurs in the middle of the day, is assumed to grow at the same rate as the peak 60-minute period for deplaning passengers arriving between 11 a.m. and 2 p.m.: a growth factor of 1.62 from 2014 to PAL 4.

Table 4-18
Upper Drive Curbside Volumes
Seattle-Tacoma International Airport

| | Base year (2014) | PAL 1 2019 | PAL 2 2024 | PAL 3 2029 | PAL 4 2034 |
|-----------------------------------|------------------|---------------|---------------|---------------|---------------|
| Private vehicles | 953 | 1,077 | 1,149 | 1,218 | 1,352 |
| Taxicabs | 140 | 159 | 169 | 180 | 199 |
| Limousines | 96 | 109 | 116 | 123 | 136 |
| Shared ride vans | 22 | 25 | 27 | 29 | 32 |
| Scheduled vans/buses (Airporters) | 13 | 13 | 13 | 13 | 13 |
| Charter buses | 2 | 2 | 2 | 2 | 2 |
| Other vehicles | <u>14</u> | <u>16</u> | <u>17</u> | <u>18</u> | <u>19</u> |
| Total | 1,240 | 1,401 | 1,493 | 1,583 | 1,753 |

Source: InterVISTAS, October 2016.

Table 4-19
Lower Drive Curbside Volumes
 Seattle-Tacoma International Airport

| | Base year 2014 | PAL 1 2019 | PAL 2 2024 | PAL 3 2029 | PAL 4 2034 |
|--------------------|-------------------|---------------|---------------|---------------|---------------|
| Private vehicles | 1,104 | 1,487 | 1,611 | 1,671 | 1,785 |
| Rental car shuttle | 138 (a) | 167 | 193 | 219 | 245 |
| Public transit | <u>8 (b)</u> | <u>8</u> | <u>8</u> | <u>8</u> | <u>8</u> |
| Total | 1,250 | 1,662 | 1,812 | 1,898 | 2,038 |

(a) Based on schedule required for 2,000 passengers per hour (55 second headways).

(b) Assumes 3 routes operating in two directions at 10-minute headways.

Source: InterVISTAS, October 2016.

4.4.4.5 Curbside Requirements

Curbside requirements are based on the curbside roadway level of service (LOS), which provides an overall indication of the quality of the experience of drivers and passengers using the curbside roadway. The primary element defining the LOS at an airport curbside roadway is the ability of a motorist to enter and exit the curbside space of their choice (e.g., one near their airline door or other chosen destination). As roadway demands and congestion increase, motorists are required to stop in spaces further away from their preferred destination. This requires the motorist to either stop in a downstream curbside space, double-park, or in an extreme case, circle past the curbside area multiple times while searching for an empty space.

The key measures defining the LOS of a curbside roadway are (a) the number of vehicles parked or stopped in the curbside lane, and the percent that are double-parked, triple-parked, or otherwise stopped in a position that interferes with the flow of traffic in adjacent lanes and (b) the volume-to-capacity ratio (v/c) of the total vehicles using the roadway. These measures are a function of the curbside demand versus the available capacity.

Level of service “C” is desirable for design of a new facility or for an existing facility at medium-hub airports, recognizing that during peak hours and days of the year the level of service may fall to “D” or poorer. Level of service on curbside roadways is estimated separately for through traffic and for curbside loading/unloading traffic, but the overall LOS is governed by the poorer of the two components.

Table 4-20 summarizes the curbside facility requirements for the Main Terminal for Baseline (2014) through PAL 4. These requirements reflect the volumes presented in Table 4-18 and Table 4-19, the dwell times and vehicle lengths presented in Table 5-16, and an assumption that demand is uniformly distributed along the curbside length. In practice, dwell times have traditionally been longer and curbside demand has been concentrated in front of major air carriers (i.e., Alaska Airlines). However, dwell times and distribution along the curb can be addressed in whole or in part through increased

curbside enforcement and other operational strategies intended to improve the distribution of demand along the curbside.

**Table 4-20
Curbside Requirements
Seattle-Tacoma International Airport**

| | Required curbside length (linear feet) | | | | | | Required number of total roadway lanes (assuming required curbside length is provided) | | | | | |
|---------------------|--|--------------|--------------|--------------|--------------|--------------|--|----------|------------|------------|--------------|--------------|
| | Existing capacity | 2014 | PAL 1 2019 | PAL 2 2024 | PAL 3 2029 | PAL 4 2034 | Existing lanes | 2014 | PAL 1 2019 | PAL 2 2024 | PAL 3 2029 | PAL 4 2034 |
| | Upper Drive | 1,200 | 1,070 | 1,180 | 1,260 | 1,320 | 1,460 | 4 | 4 | 4 | 4 | 4 |
| Lower Drive | | | | | | | | | | | | |
| Unallocated curb | 1,050 | 960 | 1,250 | 1,350 | 1,390 | 1,480 | - | - | - | - | - | - |
| Rental car shuttles | 360 | 480 | 600 | 720 | 780 | 900 | - | - | - | - | - | - |
| Public transit | 120 | 120 | 120 | 120 | 120 | 120 | - | - | - | - | - | - |
| Total | 1,530 | 1,560 | 1,970 | 2,190 | 2,290 | 2,500 | 5 | 4 | 5 | 5 | 6 (a) | 6 (a) |

LOS = level of service

(a) LOS D can be achieved with 5 lanes.

Source: InterVISTAS Inc., 2016.

4.4.5 Commercial Vehicle Facilities

Currently, commercial vehicles pick up in two areas of the Airport: the 3rd floor of the Main Garage and the South Ground Transportation Lot. In general, the 3rd floor of the Main Garage serves the on-demand modes (such as taxicabs and limousines) and courtesy vehicles (which, during peak periods, typically operate on a schedule). The South Ground Transportation Lot predominately serves charter buses and scheduled van and bus services (airporters).

4.4.5.1 Methodology

Commercial vehicle facility requirements are calculated by one of two methods depending on the operating characteristics of the mode. In general, each discrete mode requires dedicated loading spaces to ensure customers can easily find their desired transportation mode.

- Vehicles operating on an on-demand basis** (e.g., taxicabs, limousines, shared-ride vans). Design hour vehicle volumes are combined with the assumed dwell times to determine the average number of vehicles simultaneously picking up passengers. This average value is then adjusted to reflect the 95th percentile number of vehicles expected to simultaneously pick up passengers during the design hour for that mode, which indicates the number of discrete loading positions required for that mode.

- **Vehicles operating on a scheduled basis** (e.g., airporters, rental car shuttles, courtesy shuttles, and public transit). For each mode, vehicle volumes are combined with the assumed dwell times to determine the average number of vehicles simultaneously picking up passengers. Due to the scheduled nature of these vehicles, there is a low likelihood of peaking within the hour. Thus, requirements reflect the average number of vehicles expected to be loading and/or unloading simultaneously.

4.4.5.2 Dwell Times

Table 4-21 summarizes the dwell times assumed for each mode. The dwell time values are based on typical values suggested in *ACRP Report 40* as well as values used in prior curbside analyses at the Airport and reflect the time required for *active* loading of a vehicle during a typical busy period of the day. During less busy periods, on-demand modes (such as taxicabs) that are expected to wait for customers typically have dwell times exceeding the active loading time, but these longer dwell times should not be used to estimate facility requirements.

Table 4-21
Commercial Vehicle Loading Times
 Seattle-Tacoma International Airport

| | Active loading time (minutes) |
|-------------------------------------|----------------------------------|
| Taxicabs | 1.0 |
| On-call limousines | 2.0 |
| Pre-arranged limousines (a) | 60 |
| Shared ride vans | 4.0 |
| Transportation Network Companies | <i>[to come]</i> |
| Scheduled buses / vans (airporters) | 15.0 |
| Rental car shuttle | 3.5 |
| Public transit | 2.0 |

(a) Provides time for driver to meet customer inside the terminal.

Source: InterVISTAS, October 2016.

4.4.5.2 Design Hour Volumes

Table 4-22 summarizes the design hour volumes for each commercial vehicle mode. These volumes are based on (a) 2014 traffic counts conducted in August and September 2014 and (b) vehicle classifications provided in Table 4-17. Volumes are escalated in direct proportion to expected growth in peak period passengers during the Airport’s peak month. Commercial vehicle volumes, which are predominately linked to deplaning passenger volumes, which peaks in the middle of the day, are assumed to grow at the same rate as the peak 60-minute period for deplaning passengers arriving between 11 a.m. and 2 p.m.: a growth factor of 1.62 from 2014 to PAL 4.

Table 4-22
Commercial Vehicle Pickup Volumes
 Seattle-Tacoma International Airport

| | Base year (2014) | PAL 1 2019 | PAL 2 2024 | PAL 3 2029 | PAL 4 2034 |
|--|---------------------|---------------|---------------|---------------|---------------|
| <i>3rd Floor of the Main Garage</i> | | | | | |
| Taxicabs | 291 | 387 | 405 | 438 | 492 |
| On-call limousines | 11 | 14 | 15 | 16 | 18 |
| Shared-ride vans | 18 | 24 | 25 | 27 | 30 |
| Pre-arranged limousines | 5 | 6 | 6 | 7 | 8 |
| <i>Transportation Network Companies (a)</i> | | | | | |
| Courtesy vehicles (b) | 178 | 190 | 123 | 197 | 215 |
| Crew vans | 12 | 16 | 17 | 18 | 21 |
| Downtown shuttle (c) | 2 | 2 | 2 | 2 | 2 |
| <i>South Ground Transportation Lot</i> | | | | | |
| Scheduled airporters (d) | 8 | 8 | 8 | 8 | 8 |
| Charter buses – drop-off (e) | 30 | 40 | 44 | 45 | 49 |
| Charter buses – pickup (e) | 30 | 40 | 44 | 45 | 49 |

(a) To come.

(b) Includes courtesy vehicles operated by hotels, motels, and off-Airport parking operators. Volume growth reflects estimated increase in the number of operators, not increase in passenger activity.

(c) Scheduled service (two trips per hour).

(d) Scheduled services. Peak hour volumes would increase based on introduction of new operators or increased frequencies. To increase capacity, most existing operators could choose to operate larger vehicles rather than increase the number of trips.

(e) Charter bus peak volumes reflect cruise ship charter bus activity during summer months. Volumes are based predominately on number of cruise ships (and boat capacity) using downtown Seattle piers. Absent cruise ship forecasts, demand is assumed to increase at similar rate as midday arriving passengers.

Source: InterVISTAS, October 2016.

4.4.5.3 Loading Requirements

Table 4-23 summarizes the number of required loading spaces for commercial ground transportation. For taxicabs, on-call limousines, shared-ride vans, and pre-arranged limousines, loading requirements reflect the number of loading spaces needed to accommodate demand during peak periods within the peak hour. For courtesy vehicles, requirements reflect predominately scheduled operations (which are less likely to peak within the peak hour) and two stops along the courtesy van islands. Requirements for scheduled airporters provide an allowance for one additional stall during the planning period, but that is provided only as a reserve in the event a new route is introduced and/or existing operators choose to add departures during the peak hour. Charter bus drop-off requirements reflect the number of loading spaces needed to accommodate demand during peak periods within the peak hour while charter bus pickup requirements assume minimal peaking due to use of access control that meters arrivals of vehicles into the pickup area.

In addition, taxicab operations require a close-proximity feeder queue from which vehicles can rapidly fill loading spaces once they are vacated. Requirements assume this area is sized to provide a 10-minute supply of taxicabs, which is approximately the length of time required to travel from the remote hold lot to the loading areas during congested roadway conditions.

Table 4-23
Commercial Vehicle Loading Area Requirements
 Seattle-Tacoma International Airport

| | Existing capacity (spaces) | Requirements (spaces) | | | | |
|--|----------------------------|-----------------------|------------|------------|------------|------------|
| | | 2014 | PAL 1 2019 | PAL 2 2024 | PAL 3 2029 | PAL 4 2034 |
| <i>3rd Floor of the Main Garage</i> | | | | | | |
| Taxicabs | 13 | 9 | 11 | 11 | 12 | 13 |
| Taxicab feeder queue | 70 | 48 | 64 | 68 | 73 | 82 |
| On-call limousines | 2 | 1 | 2 | 2 | 2 | 2 |
| Shared ride vans | 8 | 3 | 4 | 4 | 4 | 4 |
| Pre-arranged limousines | 48 | 8 | 10 | 11 | 11 | 12 |
| <i>Transportation Network Companies (a)</i> | | | | | | |
| Courtesy vehicles | | 20 | 22 | 22 | 22 | 24 |
| Downtown shuttle | 22 (b) | 1 | 1 | 1 | 1 | 1 |
| Airline crew vans | | 2 | 2 | 3 | 3 | 3 |
| <i>South Ground Transportation Lot</i> | | | | | | |
| Scheduled airporters (c) | 2 (d) | 2 | 2 | 2 | 3 | 3 |
| Charter buses – drop-off (e) | | 8 | 11 | 12 | 12 | 13 |
| Charter buses – pickup (e) | 20 (d) | 6 | 8 | 9 | 9 | 10 |

(a) To come.

(b) These spaces serve courtesy vehicle, the Downtown shuttle, and airline crew vans.

(c) Requirements reflect number of operators and scheduled frequency. Future requirements provide an allowance for one additional loading area through the planning period.

(d) South Ground Transportation Lot may be fully displaced by construction of the International Arrivals Facility. Charter bus spaces serve both pickup and drop-off activity.

(e) Space requirements reflect requirements during peak periods for summer cruise ship charter bus activity.

Source: LeighFisher, *Technical Memorandum No. 5 Facility Requirements and Alternatives*; InterVISTAS Inc., 2016; LeighFisher, *IAF Requirements*.

4.4.5.3 Remote Hold Facilities

Taxicabs, transportation network companies, airporters, and charter buses typically use a remote hold lot to wait until they are dispatched to the Main Terminal or just prior to their scheduled pickup time. Table 4-24 summarizes information provided by the Port of Seattle regarding hold facility capacity available in 2016 and required by PAL 4.

Table 4-24
Commercial Vehicle Hold Lot Requirements
 Seattle-Tacoma International Airport

| | Existing capacity (spaces) | PAL 4 requirement |
|----------------------------------|-------------------------------|----------------------|
| Taxicabs | 98 | 190 |
| Transportation Network Companies | 43 | 80 |
| Scheduled airporters | 9 | 14 |
| Charter buses | 18 | 30 |

Source: Port of Seattle, June 2016.

4.4.6 Public Transit Facilities

As described in Section 4.4.3.5, public transit bus services are expected to require a total of two parking positions through PAL 4, specifically, 120 linear feet if parked on a curbside.

Requirements for public transit facilities at the Airport are predominantly driven by (a) the number of individual services and/or routes serving the Airport and (b) the functional requirements of the service. Currently, transit services at the Airport include the Sound Transit light rail service and two bus routes operated by Sound Transit. As demand for the light rail service increases, it was assumed that more passengers would board each train and/or that Sound Transit would increase the frequency of trains serving the Airport.

Public transit requirements assume no change in the number of transit bus routes operating from the Airport, frequency of service during peak periods, and dwell times. In the event a new transit bus operator begins service at the Airport, the Port will attempt to accommodate the vehicles within the loading areas currently used by the Sound Transit bus services.

4.4.7 Public Parking

The methodology used to establish public parking requirements is similar to that for identifying existing requirements, as described in Section 4.3.6.

4.4.7.1 Key Assumptions

Preliminary future requirements assume:

- Passenger propensity to park (i.e., transactions per passenger) would not change through the planning period. This assumption implies the share of airline passengers choosing to park versus use other access modes (i.e., private vehicles at curbside, taxicabs, airporters, public transit) during periods associated with peak parking demand will be substantially unchanged through the planning period.

- Future parking demand will increase at the same rate as planning day passengers, as opposed to peak hour or annual passenger volumes. This assumption, which is commonly used as part of airport master plans and other long-range airport parking demand studies, reflects that parking space demand is predominately generated by airline passengers parking for long durations and therefore is the result of the accumulation of vehicles over multiple days (as opposed to activity generated by a peak hour). Furthermore, because almost all parking transactions are for 14 days or less, parking demand is more likely to mirror monthly or weekly passenger volumes than annual volumes.
- The Airport will be able to change the share of the overall long-duration parking demand accommodated in on-Airport parking facilities. Even though off-Airport operators typically adjust their prices based on changes in the price of the Main Garage and (to a lesser extent) the Doug Fox Lot, the Airport has the ability to increase or decrease its share of the long-duration parking market by changing its prices and/or services provided.
- To calculate requirements, future demand (i.e., design day vehicle accumulation) is increased by a 10% circulation factor to address a customer’s difficulty in locating available spaces in a large, full parking facility; improperly parked vehicles; out-of-service spaces (i.e., for maintenance); and other factors.

4.4.7.2 Future Demands

Using the baseline demand described in Section 4.3.6 and other key assumptions, future public parking facility requirements were calculated as shown in Table 4-25. The Main Garage and Doug Fox Lot have sufficient capacity to continue to meet demand through PAL 4. Off-Airport facilities, however, will need to increase capacity (or reduce their share of the market). Table 4-25 also shows that of the spaces served in the Main Garage and the Doug Fox Lot, approximately 87% are located in the Main Garage (which can be considered ‘close-in’ parking).

Table 4-25
Public Parking Facility Requirements (a)
 Seattle-Tacoma International Airport

| | Existing 2014 | PAL 1 2019 | PAL 2 2024 | PAL 3 2029 | PAL 4 2034 |
|------------------------------------|------------------|---------------|---------------|---------------|---------------|
| Close-in parking (Main Garage) (b) | 12,800 | 9,260 | 10,440 | 11,590 | 12,740 |
| Remote (Doug Fox Lot) | 1,620 | 1,090 | 1,230 | 1,360 | 1,500 |
| Off-Airport facilities | 18,500 | 20,400 | 23,000 | 25,500 | 28,000 |
| Total | 32,920 | 30,750 | 34,670 | 38,450 | 42,240 |

4.4.8 Employee Parking

Employee parking requirements, shown in Table 4-26, were estimated based on both forecast passenger and air cargo activity. Key assumptions related to the employee parking estimates include the following:

- The forecast number of employees using the employee parking facilities is based upon current commuting trends and assuming a modest shift of 5% of the employees to alternative modes including commuter rail, light rail, public transit, carpools, vanpools, and non-motorized modes.
- The number of passenger terminal employees was forecast based upon forecast passenger growth. The passenger terminal employee group includes employees of the airlines, the ADR program, Port of Seattle, federal agencies, and other airport related services. It was also assumed that 16% of the parking demand was met with parking stalls provided in the Main Terminal and North Terminal parking garages.
- Seattle-Tacoma International Airport Landside Operations staff have determined that to meet customer service goals they will manage the employee parking facilities to 90% occupancy. Based upon current activity levels this corresponds with 2.5 access cards per stall. The number of future parking stalls required was calculated based upon this ratio.

Table 4-26
Employee Parking Requirements
Seattle-Tacoma International Airport

| Description | Existing | PAL 1 2019 | PAL 2 2024 | PAL 3 2029 | PAL 4 2034 |
|--|----------|---------------|---------------|---------------|---------------|
| Passenger terminal | | | | | |
| Employees (a) | 11,656 | 12,300 | 13,800 | 15,600 | 17,200 |
| Employee parking stalls (b) | | | | | |
| Remote parking | 4,056 | 4,160 | 4,670 | 5,270 | 5,870 |
| Terminal garage | 754 | 740 | 830 | 930 | 1,030 |
| Subtotal | 4,810 | 4,900 | 5,500 | 6,200 | 6,900 |
| Air cargo and aircraft maintenance facilities | | | | | |
| Air cargo buildings (sf) (c) | 550,000 | 501,000 | 876,000 | 1,320,700 | 1,275,000 |
| Aircraft maintenance buildings | 346,000 | 346,000 | 346,000 | 324,000 | 324,000 |
| Remote employee parking stalls (d) (e) | 66 | 70 | 70 | 590 | 750 |
| On-site employee parking stalls (d) (e) | 1,271 | 1,280 | 1,810 | 1,720 | 1,490 |
| Total Employee Parking Stalls – Port Facilities | | | | | |
| Remote parking | 4,122 | 4,230 | 4,740 | 5,860 | 6,620 |
| Terminal garage | 754 | 740 | 830 | 930 | 1,030 |
| Subtotal | 4,876 | 4,970 | 5,570 | 6,790 | 7,650 |

(a) Employee parking forecast based upon SAMP passenger forecasts and 5% reduction for alternative modes.

(b) Assumed one stall per 2.5 employees and 85% in remote parking.

(c) Includes allowance for off-site facilities.

(d) Calculated employee parking needs at 1.4 parking stalls per 1,000 sf of building.

(e) Assumed parking remain on-site (existing condition) until facilities are redeveloped then 50% on-site/50% remote.

Source: Port of Seattle, October 2016.

- The number of cargo employee parking stalls was calculated based upon the facilities anticipated to support the cargo functions. We assumed:
 - Initially, cargo facilities will be expanded off-site; off-site facilities will be sized to accommodate employee parking needs.
 - The existing central cargo facilities (e.g., Swissport) will likely be displaced by passenger-related development and that the north cargo (e.g., Transiplex) facilities will be redeveloped in order to maximize the site for air cargo functions. Thus, 50% of the employee parking needs must be accommodated off-site.
 - If the South Aviation Support Area (SASA) is developed to support cargo functions, then that site would be maximized for aircraft and cargo functions, resulting in 50% of the employee parking needs being accommodated off-site.
 - The overall requirement is for 1.4 parking stalls per 1,000 SF of cargo building.
- The number of aircraft maintenance employee parking stalls was calculated based upon the facilities anticipated to support the aircraft maintenance functions. We assumed that if the existing aircraft maintenance facilities are relocated to a different on-Airport location, then 50% of the employee parking needs must be accommodated off-site. The overall forecast assumes 1.4 parking stalls per 1,000 SF of building.

4.4.9 *Rental Car Facilities*

For planning purposes, it is assumed that the total area required for rental car facilities when the Airport serves 66 MAP can be calculated by assuming proportional growth with annual passengers. Thus, by 66 MAP, the existing RCF will need to grow by approximately 15.8%, which equates to an additional 270,000 square feet.

4.4.10 *Non-motorized Access*

Options for pedestrians and bicyclists to access the Airport terminal are limited. The requirement is to ensure that advanced planning and design related to future landside facilities consider maintaining and improving access to the existing terminal as well as connectivity to any future terminals.

4.4.11 *Long-Term Operations*

Cruise ship passengers are an important and growing source of airport passenger activity. Over one million cruise ship passengers are expected on the Seattle waterfront in 2017. A small percentage of cruise passengers also arrive from, and depart to, the Vancouver, BC waterfront.

Mid- and long-term solutions for cruise ship facilities at the airport will be developed by the Advanced Planning Team following completion of the SAMP. These solutions will be planned to accommodate phased implementation of roadways and terminal expansion. Airport and Seaport Operations will also continue to develop and refine strategies for shifting check-in activities away from the airport, although there is limited space at both the airport and waterfront for these facilities. The Port is currently trying a pilot program to provide free bag service as a strategy to deal with the limited space.

Air Cargo

This chapter presents assessments of existing air cargo facilities and summarizes the requirements that must be satisfied to accommodate the aviation activity forecast through the 20-year planning period.

5.1 Introduction

The Port Commission's Century Agenda strategic goal, adopted in January 2012, is to position the Puget Sound region as a premier international logistics hub with the objective to triple 2013 annual air cargo volume to 750,000 metric tons by 2037. This section summarizes the facility requirements for accommodating the volume of air cargo specified by the Century Agenda as well as the volume of air cargo forecast for PALs 1 through 4. The Century agenda air cargo volume exceeds the forecast air cargo activity by approximately 40%.

The scope of the air cargo requirements analyses related to on-Airport facilities and operations and included (1) identifying existing air cargo freighter hardstands and air freight, integrator freight, and airmail warehouse facilities, current tenants, and the cargo volumes able to be accommodated, (2) assessing key issues and limitations related to the existing cargo facilities, including those related to the ramps, warehouses, and landside areas (3) gathering appropriate benchmark data, (4) recognizing key dimensional criteria and necessary functional relationships (e.g., the proximity of freighter hardstands to cargo warehouses), and (5) discussing with operations staff how the Airport's cargo facilities are likely to be operated in the future.

Air cargo requirements were prepared and evaluated using a collaborative approach which involved cargo operators, tenants, and Port planning and operations staff. A key assumption was that all air cargo activity currently accommodated will remain at the Airport through the 20-year planning period.

5.2 Existing Air Cargo Facilities and Operations

The locations of air cargo warehouse facilities and ramp areas are shown on Figure 5-1. The space utilized for air cargo in each of the cargo facilities identified in Figure 51 is summarized in Figure 5-2. Existing air cargo facilities are typically small, inefficient, and accommodate various cargo volumes.

There are 17 aircraft hardstands at the Airport that are currently used to accommodate cargo aircraft; other hardstands could accommodate cargo aircraft if necessary. The aircraft hardstands are located in eight areas, Cargo 1 through Cargo 7 and Alaska Airlines Air Cargo, as shown in Figure 51.

With the exception of FedEx (Building #7), warehouses at the Airport do not employ a high level of mechanization or sophisticated cargo storage & handling systems. Instead their operations rely on simple forklifts, dollies, and tugs; at most warehouses, cargo is stored directly on the floor for processing and storage during its short dwell time.

Figure 5-1
Existing Air Cargo Warehouse Locations
 Seattle-Tacoma International Airport

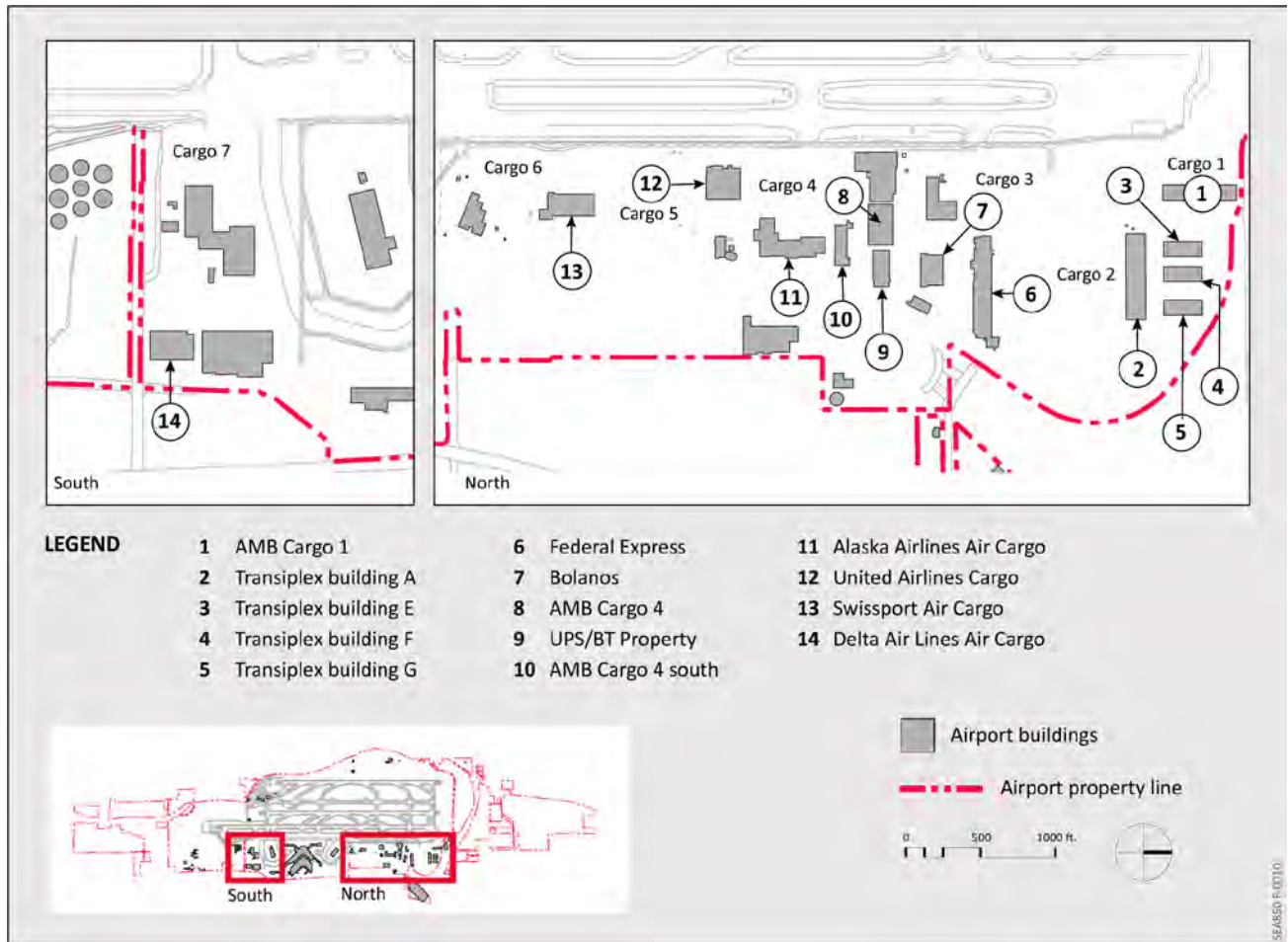

Source: Logplan, 2016.

Current issues at cargo facilities are more attributable to layout-related congestion than to actual capacity deficits. This congestion is exacerbated by activity generated by non-cargo operations, such as the Port's aviation maintenance facility, flight kitchen, and United Airlines maintenance operations interspersed within the cargo campus.

The nature of the commercial relationships between the Airport and its cargo tenants constrains the Airport's ability to impose a strict cargo-oriented policy. Tenants are free to sub-lease Airport property originally designated for cargo to non-cargo users, and the Airport has little ability to control such behavior. Additionally, in contrast with business arrangements at other international airports, Airport staff is not involved in determining or mandating service levels and standards. The result is an assortment of relatively small warehouses, each operating individually as best suits its own interests, and the less than optimum utilization of the relatively large area currently allocated to cargo operations.

Table 5-1
Summary of Air Cargo Warehouse Tenants, Areas, and Utilizations
 Seattle-Tacoma International Airport

| Tenant (Building #) | 2013 Cargo volume (metric tons) | Warehouse (sq. ft.) | Space utilized (sq. ft.) | Utilization (tons/sq. ft. /yr.) |
|--------------------------------------|------------------------------------|------------------------|-----------------------------|------------------------------------|
| Single Tenant | | | | |
| FedEx (#6) | 102,642 | 73,250 | 73,250 | 1.40 |
| Southwest (#10) | 4,838 | 25,700 | 11,000 | 0.44 |
| Alaska Airlines (#11) | 28,125 | 68,730 | 68,730 | 0.41 |
| Delta Air Lines (#14) | 31,478 | 58,000 | 58,000 | 0.54 |
| Cargo Handling Company | | | | |
| Hanjin (#2) | 16,511 | 84,000 | 23,600 | 0.70 |
| CAS (#8) | 29,771 | 48,520 | 48,520 | 0.61 |
| Swissport (#13) | 40,864 | 31,560 | 31,560 | 1.57 |
| WFS – Transiplex E (#3) | 2,866 | 25,000 | unknown | unknown |
| Other Cargo Facilities | | | | |
| Transiplex G – USPS – Matheson (#5) | unknown | 25,000 | 25,000 | unknown |
| FedEx Heavy Freight & Matheson (#1) | 31,989 | 51,720 | 15,000 | 2.13 |
| Building #12 | Vacant | <u>49,260</u> | -- | n/a |
| Total | | 540,740 | 354,660 | |

Sources: Port of Seattle, Webber Air Cargo, and Logplan LLC, May 2014.

5.3 Desired Air Cargo Campus Characteristics and Planning Assumptions

5.3.1 Warehouse Locations

Airport facilities that accommodate belly cargo and freighter cargo, which are cargo accommodated in the cargo compartments of passenger aircrafts and in freighter aircrafts, respectively, should be located to minimize the transfer time of cargo between the aircrafts and the warehouses. Such transfers typically involve using tugs and dollies traveling on the Airport’s vehicle service roads. Therefore, warehouses accommodating belly cargo should be as close as possible to passenger aircraft gates and warehouses accommodating freighter cargo should be as close as possible to the freighter hardstands.

Cargo warehouses should be located to (1) facilitate access to both landside facilities (i.e., the Airport and regional roadway system) and airside facilities (i.e., taxiways and runways), (2) provide adequate airside space to accommodate freighter aircraft parking positions, ground service equipment and unit load device storage and operating space, and (3) provide adequate landside space to facilitate shipping, receiving, and customer access functions.

A single location for air cargo facilities is preferable to multiple locations to (1) reduce truck traffic on the Airport access roadway system, (2) reduce vehicle emissions, and (3) improve customer service.

Assuming that airmail continues to be contracted mainly to FedEx (or a new entrant integrated carrier), the preferred location for any replacement airmail facility would be adjacent to (or integrated with) the integrated carrier facility.

5.3.1.1 Warehouse Utilization

Cargo warehouse utilization is measured by the metric cargo tons per square foot per year. There is considerable variability in the utilization rates in air cargo facilities, depending on a number of factors such as the type of cargo facility (e.g., air freight, integrator, or airmail), level of mechanization and automation, airport size, extent of hubbing and transshipment cargo, characteristics of the cargo and cargo operators, and dwell time.

Benchmarking analyses performed by LeighFisher indicate the following.

- Facilities at large airports with a high percentage of transshipment cargo, such as facilities at Incheon, Dubai, Abu-Dhabi, Shanghai Pudong, and Tokyo Narita international airports, achieve utilization rates of 1.5 - 2.5 ton per square foot per year.
- Facilities at other large airports with less transshipment cargo, such as facilities at Hong Kong, Kansai, Singapore, and Bangkok international airports achieve utilization rates of 1 - 1.5 ton per square foot per year.

All these airports are equipped with modern mechanized and automated storage and handling systems to handle over 1 million tons of cargo per year. In contrast to these modern facilities, some older facilities experience long dwell times due to outdated customs and security procedures. As a result, their utilization rates are approximately 0.65 ton per square foot per year.

Utilization rates at most U.S. airports are estimated at 0.5 -1.0 tons per square foot per year.

5.3.1.2 Potential Long-Term Utilization Rates at the Airport

- **Air freight:** If the Airport's current system of multiple, decentralized, multiple operator warehouses continue, it is assumed that the average utilization rate can be improved up to 0.7 tons per square foot per year by improving manual equipment and handling techniques.
- **Integrator Freight:** In the absence of specific information regarding the operation of other integrators at the Airport, it has been assumed that (1) future utilization will be based on FedEx's existing facility utilization of 1.84 tons per square foot per year, (2) FedEx's existing facility will reach capacity at 2018, at which it will reach utilization of about 2.0 tons per square foot per year, and (3) a utilization of 1.5 tons per square foot per year will be used to estimate requirements for all future integrator freight facilities.
- **Airmail:** Airmail volume has decreased significantly, as the internet has replaced postal services over the past 10 years. This trend is expected to continue and airmail will remain marginal at most airports, including SEA. It is assumed that the current utilization of

approximately 1.0 tons per square foot per year should be used for future planning purposes.

5.3.1.3 Air Freight Warehouse Operating Concepts (Business Models)

Air freight warehouse operating Concept #1 refers to multiple warehouses, multiple operators, single- and multiple-tenants, and non-mechanized facilities and reflects the existing facilities and business arrangements at the Airport. With some improvements in operating methods, it is believed the long-term utilization of air freight warehouses under this operating concept could be improved to 0.7 tons per square feet annually.

Air freight warehouse operating Concept #2 refers to a limited number of warehouses and operators with multiple users and mechanized facilities. The long-term utilization of air freight warehouses under this operating concept is expected to be approximately 1 ton per square foot per annually. Implementation of this operating concept would require significant changes in business practices at the Airport.

Given the Airport's limited land area, it is believed that cargo productivity must increase. However, the adoption of a business model incorporating large mechanized and automated multi user air freight warehouses, possibly employing multi-level cargo processing is not believed to be feasible at the Airport.

A feasible approach is to limit air freight warehouse facilities to conventional single level warehouses designed for moderate levels of automation, such as employing elevating transfer vehicle or lift and run container handling and storage techniques. This should permit productivity increases to a range of 0.7 to 1.0 tons per square foot per year.

5.3.1.4 Cargo Warehouse Site Components and Recommended Dimensions

Cargo warehouse site components and their concept dimensions were coordinated extensively with Port staff in a series of workshops.

Warehouse dimensions were developed for the key airside and landside site components based on experience of the planning team at other airports, the experience of Airport staff, and the practical limitations of land available at the Airport. The objective was to not to dictate the width of a future integrator warehouse, for example, but rather to ensure sufficient space for cargo campus development. The recommended dimensions for key cargo site components are shown graphically on Figure 5-2.

Figure 5-2
Recommended Dimensions for Key Cargo Warehouse Site Components
 Seattle-Tacoma International Airport

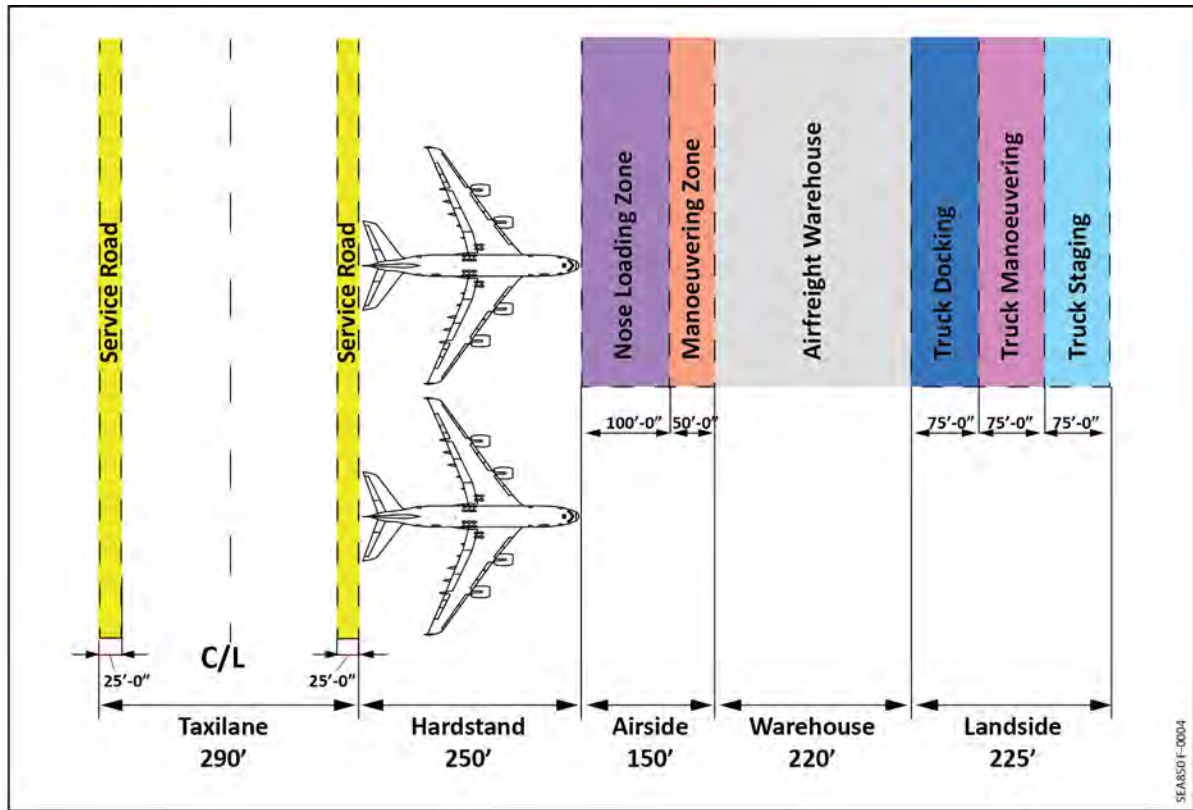

Source: LeighFisher, 2015.

5.4 Cargo Activity Forecasts

The cargo facilities requirements were based on forecasts of total cargo volumes from *Technical Memorandum No. 4 Forecasts of Aviation Activity*. The planning activity levels and the forecast years corresponding with these planning levels are summarized in Table 52.

Table 5-2
Forecast Cargo Activity (metric tons)
 Seattle-Tacoma International Airport

| | Estimated 2014 | PAL 1 2019 | PAL 2 2024 | PAL 3 2029 | PAL 4 2034 |
|--------------------|-------------------|---------------|---------------|---------------|---------------|
| Cargo volume | | | | | |
| Air freight | 163,233 | 188,370 | 211,770 | 234,090 | 253,400 |
| Integrator freight | 105,505 | 110,590 | 116,990 | 123,750 | 130,900 |
| Air mail | <u>50,752</u> | <u>52,520</u> | <u>54,160</u> | <u>55,820</u> | <u>57,470</u> |
| Total | 319,490 | 351,480 | 382,920 | 413,660 | 441,770 |

Source: *Technical Memorandum No. 4 Forecasts of Aviation Activity*, LeighFisher, March 2015.

If the level of cargo activity proposed in the Century Agenda were to be achieved by 2037, the estimated cargo volumes that would be accommodated in the intervening years are shown in Table 53.

**Table 5-3
Potential Cargo Activity Based on Century Agenda Goal for 2037 (tons)
Seattle-Tacoma International Airport**

| | Estimated 2014 | PAL 1 2019 | PAL 2 2024 | PAL 3 2029 | PAL 4 2034 | 2037 |
|--------------------|-------------------|---------------|---------------|---------------|---------------|---------------|
| Cargo volume | | | | | | |
| Air freight | 164,444 | 201,895 | 247,784 | 304,325 | 373,631 | 422,578 |
| Integrator freight | 104,535 | 128,342 | 157,571 | 193,456 | 237,513 | 268,628 |
| Air mail | <u>50,863</u> | <u>52,520</u> | <u>54,160</u> | <u>55,820</u> | <u>57,470</u> | <u>58,794</u> |
| Total | 319,842 | 382,757 | 459,515 | 553,601 | 668,614 | 750,000 |

Sources:

Cargo volumes estimated by LeighFisher based on Port of Seattle Commission Century Agenda.

Activity for PALs 1 - 4 estimated by Logplan assuming (a) historical relationships among air freight, integrator freight, and mail, and (b) uniform compound annual growth between 2014 and 2037.

5.5 Cargo Warehouse and Freighter Hardstand Requirements

5.5.1 Cargo Warehouse Requirements

Cargo warehouse requirements were estimated (1) based on forecast cargo activity, shown in Table 52, (2) potential cargo activity based on the Century Agenda goal, shown in Table 53, and (3) assuming two operating concepts, as described in Section 5.3.1.3. Cargo warehouse requirements were estimated by dividing the annual forecast cargo volumes for air freight, integrator freight, and mail by assumed warehouse utilization rates. Utilization rates are shown in Table 54. Cargo warehouse requirements are presented in Table 55 and Table 56 for forecast activity and Century Agenda activity, respectively.

**Table 5-4
Long-Term Warehouse Utilization Rates (tons/sq. ft. /yr.)
Seattle-Tacoma International Airport**

| | Air freight | | Integrator Freight | Air Mail |
|-------------|--------------------|--------------------|--------------------|----------|
| | Operating Model #1 | Operating Model #2 | | |
| Utilization | 0.7 | 1.0 | 1.5 | 1.0 |

Source: Logplan, November 2014.

Table 5-5
Cargo Warehouse Requirements for Forecast Cargo Activity (sq. ft.)
 Seattle-Tacoma International Airport

| Cargo type | Utilization (tons/sq. ft./yr.) | Forecast | | | |
|-----------------------------|-----------------------------------|---------------|---------------|---------------|---------------|
| | | PAL 1 2019 | PAL 2 2024 | PAL 3 2029 | PAL 4 2034 |
| Operating Concept #1 | | | | | |
| Air freight | 0.7 | 270,000 | 303,000 | 335,000 | 362,000 |
| Integrator freight | 1.5 | 74,000 | 78,000 | 83,000 | 87,000 |
| Air mail | 1.0 | <u>53,000</u> | <u>54,000</u> | <u>56,000</u> | <u>57,000</u> |
| Total | n/a | 397,000 | 435,000 | 474,000 | 506,000 |
| Operating Concept #2 | | | | | |
| Air freight | 1.0 | 188,000 | 212,000 | 234,000 | 253,000 |
| Integrator freight | 1.5 | 74,000 | 78,000 | 83,000 | 87,000 |
| Air mail | 1.0 | <u>53,000</u> | <u>54,000</u> | <u>56,000</u> | <u>57,000</u> |
| Total | n/a | 315,000 | 344,000 | 373,000 | 397,000 |

Source: Logplan, November 2014.

Table 5-6
Cargo Warehouse Requirements for Century Agenda Cargo Activity (sq. ft.)
 Seattle-Tacoma International Airport

| Cargo type | Utilization (tons/sq. ft./yr.) | Forecast | | | |
|-----------------------------|-----------------------------------|---------------|---------------|---------------|---------------|
| | | PAL 1 2019 | PAL 2 2024 | PAL 3 2029 | PAL 4 2034 |
| Operating Concept #1 | | | | | |
| Air freight | 0.7 | 288,000 | 354,000 | 435,000 | 534,000 |
| Integrator freight | 1.5 | 86,000 | 105,000 | 129,000 | 158,000 |
| Air mail | 1.0 | <u>53,000</u> | <u>54,000</u> | <u>56,000</u> | <u>57,000</u> |
| Total | n/a | 427,000 | 513,000 | 620,000 | 749,000 |
| Operating Concept #2 | | | | | |
| Air freight | 1.0 | 202,000 | 248,000 | 304,000 | 374,000 |
| Integrator freight | 1.5 | 86,000 | 105,000 | 129,000 | 158,000 |
| Air mail | 1.0 | <u>53,000</u> | <u>54,000</u> | <u>56,000</u> | <u>57,000</u> |
| Total | n/a | 341,000 | 407,000 | 489,000 | 589,000 |

Source: Logplan, November 2014.

5.5.2 Freighter Hardstand Requirements

Freighter airline hardstand requirements, summarized in 5-7, were estimated based on an evaluation of scheduled and actual international freighter operations during the peak month, July 2014.

**Table 5-7
Freighter Hardstand Requirements
Seattle-Tacoma International Airport**

| | Typical Aircraft | Estimated 2014 | Forecast | | | |
|----------------------------------|------------------|----------------|------------|------------|------------|------------|
| | | | PAL 1 2019 | PAL 2 2024 | PAL 3 2029 | PAL 4 2034 |
| International freighters | B747-8F | 4 | 5 | 5 | 6 | 6 |
| Diverted flights and maintenance | B747-8F | 2 | 2 | 3 | 3 | 3 |
| Integrator freighters | B777-F | 6 | 6 | 7 | 8 | 8 |
| Domestic freighters | B737-F | 2 | 2 | 2 | 2 | 2 |
| Total | | 14 | 15 | 17 | 19 | 19 |

Source: LeighFisher, November 2014.

The strategy for planning freighter aircraft hardstands was to plan to accommodate B747-8F aircraft on new hardstands. The recommended dimensions for hardstands and the airside operating area are shown in Figure 5-3. If the present FedEx facility remains or is redeveloped at its present location, it is proposed that the existing freighter stands for this site will remain unchanged.

5.5.3 Landside Cargo Facilities Requirements

This section summarizes landside facilities requirements for air freight truck docks and maneuvering areas, truck staging areas, employee parking, customer parking, and access roads. These requirements are specifically applicable to air freight warehouses. Landside requirements associated with integrator and airmail warehouses or other warehouse support facilities should be developed as part of follow-on planning and design efforts.

Air freight truck dock requirements were estimated based on a planning factor of 0.3 truck docks per 1,000 square feet of air freight warehouse building, as recommended by the Airports Council International North America in its *Air Cargo Guide*. This planning factor is suitable for master planning only. These requirements are summarized in Table 5-8.

A distance of 150 feet from the face of the cargo warehouse to the access roadway would provide sufficient space for truck maneuvering. A one way traffic flow in the truck maneuvering area is preferred for maneuvering efficiency and safety.

Truck access to the truck docking and maneuvering area can be either controlled or un-controlled. With controlled access, a landside gate would be required to restrict vehicle access so that vehicles are only able to enter the truck docking or staging areas when sufficient docking or staging space is

available. At present, uncontrolled access is the norm at the Airport; this approach should continue until conditions necessitate the implementation of controlled access.

**Table 5-8
Air Freight Warehouse Dock Requirements
Seattle-Tacoma International Airport**

| | Estimated 2014 | Forecast | | | |
|--------------------------------------|-------------------|---------------|---------------|---------------|---------------|
| | | PAL 1 2019 | PAL 2 2024 | PAL 3 2029 | PAL 4 2034 |
| Forecast cargo activity | | | | | |
| Operating concept #1 | 70 | 81 | 91 | 100 | 109 |
| Operating concept #2 | 49 | 57 | 64 | 70 | 76 |
| Century Agenda cargo activity | | | | | |
| Operating concept #1 | 63 | 78 | 96 | 118 | 146 |
| Operating concept #2 | 44 | 56 | 67 | 83 | 102 |

Source: Logplan, November 2014.

Truck staging areas contribute to efficient cargo operations, particularly when docks are occupied. These areas should be as close as possible to the truck docks. As cargo tonnage at the warehouses increases it may become necessary to provide remote staging areas and require trucks without a confirmed drop off or pick up reservation to report initially to the remote staging area, prior to being released to the assigned truck dock.

Typically, a minimum of two to eight employee parking spaces should be provided for every 1,000 square feet of warehouse and two to eight spaces for 1,000 square feet of office. Where development area is limited, alternative locations for employee parking should be considered. Employee and customer parking areas should be separate from truck maneuvering areas to improve efficiency and safety.

On-airport cargo warehouses are not typically high customer activity areas. An industry standard planning parameter for single tenant warehouses is a requirement of one customer parking space per 10,000 square feet of cargo building. If the warehouse is allocated to multiple tenants, a higher ratio is appropriate.

Airline Support

This chapter presents assessments of existing airline support facilities and summarizes the requirements that must be satisfied to accommodate the aviation activity forecast through the 20-year planning period.

6.1 Introduction

Airline support facilities include aircraft maintenance hangars, flight kitchens, ground handling service facilities, fuel storage and distribution facilities, and office space. This section identifies the airline support facilities considered during the SAMP, describes the existing facilities and operations, describes key planning assumptions, and summarizes airline support facility requirements for PAL 1 through PAL 4 (2019, 2024, 2029, and 2034, respectively).

6.2 Airline Support Facilities, Operations, and Requirements

6.2.1 Aircraft Maintenance Hangars

Alaska Airlines has two aircraft maintenance hangars located to the south of the South Satellite. Delta Air Lines has a single aircraft maintenance hangar located adjacent and to the east of the Alaska hangars. Neither Alaska Airlines nor Delta Air Lines has stated the requirement for additional aircraft maintenance hangars during the planning period. It is assumed therefore, that the current facilities are adequate for the planning period and, should they need to be relocated, they would be replaced in kind at a different on-Airport location.

6.2.2 Flight Kitchens

There are currently three providers of aircraft food and beverage services to the airlines (i.e., flight kitchens) operating at the Airport—Gate Gourmet, Flying Foods and SkyChef.

The airlines and their service providers are responsible for determining the requirements for the flight kitchens. Locating the flight kitchens on Airport property is a convenience but not a necessity. The Port's intention is to continue leasing convenient on-Airport property to the service providers as long as the property is not needed for a higher-priority use.

6.2.3 Ground Handling Services Facilities

Airline ground handling services include aircraft loading and unloading, fueling, de-icing; baggage sorting, ground power unit service, aircraft push-back and towing, aircraft servicing and cleaning, aircraft security, and ground service equipment repair and maintenance. Ground handling services are currently provided at the Airport by airline personnel and third party providers Aircraft Service International Group and Swissport operating from leased facilities.

The future requirements for ground handling services facilities at the Airport will increase as the volume of passenger and aircraft activity increases. Because the Airport is land poor, most facilities accommodating ground handling services will be demolished to allow the development of additional gates. Therefore, both the ground handling services facilities requirements and locations will be changing. The specific requirements for such new facilities will be determined during the advanced planning after the SAMP is completed.

6.2.4 Fuel Storage and Distribution Facilities

Jet fuel is delivered to the Airport from multiple refineries in Northern Washington via the Olympic Pipeline. The deliveries of jet fuel share capacity in the pipeline with other petroleum products being delivered as far south as Eugene Oregon. There is concern about the operational impact at the Airport, of supply disruptions and the potential requirement for a backup delivery source other than over-the-road tankers (e.g., a second pipeline). The need for, and ability to implement, such a backup delivery source would involve off-Airport facilities and should be explored in advanced planning.

The Airport's airline fuel storage facilities (i.e., the fuel "farm") consist of eight above-ground storage tanks with a total gross capacity of 17,331,000 gallons of fuel. The Port leases the fuel farm land to the fuel system owner, SeaTac Fuel Facilities Inc. Fuel for general aviation is stored separately by the FBO in underground storage tanks located on the FBO leasehold.

Requirements for the future fuel tank storage capacity were based on an analysis of historical fuel flowage and aircraft operations data for 2014 and the following planning guidelines and assumptions:

- Peak fuel demand calculations are based upon the average day peak month (ADPM) operations.
- In July 2014 (the peak month for fuel flowage), an average of 3,342 gallons of jet fuel per departure was dispensed and the fuel farm had 8.8 days of fuel reserves.
- Future jet fuel requirements were projected by determining the product of three factors: forecast ADPM for passenger and cargo airline departures, average jet fuel dispensed per aircraft departure in the peak month, and the number of day's reserves desired.

Projected jet fuel storage requirements are presented in Table 6-1.

The existing underground fuel distribution system delivers fuel to 167 hydrant pits located at fixed aircraft parking positions. The system is well maintained and can be expanded to meet future fueling needs as the Airport's gate facilities are expanded.

Table 6-1
Projected ADPM Airline Jet Fuel Demand and Gross Storage Required
to Provide 3-, 5-, 7-, and 10-Day Reserves
Seattle-Tacoma International Airport

| | 2014 Baseline | PAL 1 2019 | PAL 2 2024 | PAL 3 2029 | PAL 4 2034 |
|--|------------------|---------------|---------------|---------------|---------------|
| Annual aircraft operations (a) | 340,478 | 398,910 | 448,860 | 497,180 | 540,400 |
| Peak month aircraft operations (b) | 32,615 | 38,264 | 43,098 | 47,774 | 51,956 |
| ADPM aircraft operations (c) | 1,302 | 1,417 | 1,571 | 1,743 | 1,901 |
| ADPM average jet fuel dispensed per departure (gallons) (d) | 3,348 | 3,348 | 3,348 | 3,348 | 3,348 |
| ADPM jet fuel demand (gallons) (e) | 2,179,500 | 2,372,100 | 2,629,900 | 2,917,800 | 3,182,300 |
| Gross jet fuel storage requirements (gallons) (f) | | | | | |
| 3-day reserve supply | 7,265,000 | 7,907,000 | 8,766,300 | 9,726,000 | 10,607,700 |
| 5-day reserve supply | 12,108,300 | 13,178,300 | 14,610,600 | 16,210,000 | 17,679,400 |
| 7-day reserve supply | 16,951,700 | 18,449,700 | 20,454,800 | 22,694,000 | 24,751,200 |
| 10-day reserve supply | 24,216,700 | 26,356,700 | 29,221,100 | 32,420,000 | 35,358,900 |

(a) From LeighFisher, *Technical Memorandum 2 - Aviation Demand Forecasts, March 2015*.

(b) Calculated based upon flight schedules for both passenger and cargo airlines.

(c) Calculated based upon flight schedules for both passenger and cargo airlines.

(d) Based on jet fuel dispensed per departure in July 2014.

(e) Calculated by multiplying ADPM departures (total operations divided by two) by the ADPM average jet fuel dispensed per departure.

(f) Includes adjustment factor to account for "bottoms" in the tank (90% of gross tank capacity contains usable fuel).

Source: Corich Group LLC based on Port of Seattle data, March 2015.

6.2.5 Office Space

Airline office space is located both in non-secure areas (e.g., the Main Terminal) and secure areas (e.g., apron level areas beneath the concourses and satellites). As part of the SAMP, the airlines have not stated requirements for additional office space. Nevertheless, it is anticipated that such requirements at the Airport will change as the volume of passenger and aircraft activity increases.

It is assumed that (a) the amount of space available for airline offices will increase in the future as additional passenger terminal and gate facilities are provided, (b) the specific needs for office space will be determined following completion of the SAMP, and (c) the Port will continue to reallocate existing office space to meet changing future needs.

Airport Support

This chapter presents assessments of existing airport support facilities and summarizes the requirements that must be satisfied to accommodate the aviation activity forecast through the 20-year planning period.

7.1 Introduction

Airport support facilities considered in the SAMP include those related to aviation maintenance, aircraft rescue and firefighting, aircraft ground run-up, concessions distribution, recycling and composting, and utilities. This section summarizes these Airport support facilities and their requirements for PAL 1 through PAL 4 (2019, 2024, 2029, and 2034, respectively).

7.2 Aviation Maintenance Facilities

The Aviation Maintenance Department maintains and supervises all Port-owned assets that are necessary for the Airport to function. The work of the Maintenance Department is conducted from facilities shown on Figure 7-1.

We anticipate that the recommended development plan may result in the need to relocate aviation maintenance facilities within SASA (i.e., the aviation maintenance distribution center, Port employee parking, and the rental car shuttle bus maintenance facility), the Cargo 4 complex, and possibly some or all of the facilities near the snow removal and large equipment storage area. The functions at each of these locations were analyzed to estimate the requirements for siting replacement facilities, should they be needed.

- **SASA.** The specific program for the replacement maintenance distribution center, Port employee parking lot, and rental car shuttle bus maintenance facility should be determined during advanced planning. For the purposes of SAMP, we assumed that if facilities are relocated, sites sufficient to accommodate facilities similar to those being relocated will be required.
- **Cargo 4.** The Cargo 4 complex accommodates functions that include vehicle maintenance, vehicle storage, the carpentry shop, and the paint shop. The largest most demanding function is vehicle maintenance. The current footprint for the facilities at Cargo 4 is approximately 4.5 acres. If Cargo 4 is relocated, a 6 acre site with access to public streets as well as direct access to the airfield is recommended. The specific program for the replacement facilities, if needed, should be determined during advanced planning.
- **Snow removal equipment and large vehicle storage.** The snow equipment and large vehicle storage shed provide open storage for snow plows, airfield runway de-icing chemicals, large trucks, and mowers. The current footprint for the facilities is approximately 5.3 acres. If these facilities are relocated, a site footprint of 7 acres is

recommended. The specific program for the replacement facilities, if needed, should be determined during advanced planning.

Figure 7-1
Location of Existing Maintenance Facilities and Shops
Seattle-Tacoma International Airport



Source: Port of Seattle, 2016.

7.3 Aircraft Rescue and Firefighting Facilities

The Airport's existing fire station is on a site of approximately 3.8 acres located at 2400 South 170th Street. We anticipate that the expansion of the Airport's passenger terminal facilities will require that the existing fire station be demolished and replaced with one or more new facilities. The requirements that will dictate the future ARFF facility or facilities and allow the Department to continue providing its existing (excellent) level of service are summarized below.

- **ARFF vehicle response time.** The FAA mandates that (a) the Department's first aircraft crash truck be able to reach the center of the runway that is furthest from the station within three minutes of the alarm sounding, and (b) two additional vehicles be able to reach the same point within four minutes.

- **ARFF fuel spill response.** An ARFF truck must be located near the terminal gates in order to quickly respond to fuel spills to prevent or extinguish any fires and to reduce the chances of environmental contamination.
- **Medical response.** A new fire station must be close enough to the passenger terminal to maintain the Department’s ability to respond rapidly to medical emergencies.
- **Structural fire response.** The station or stations must be located to permit rapid responses to structural fires at any of the Airport’s facilities.

The requirements for replacement fire station sites were developed based on Advisory Circular AC150-5210-15A Aircraft Rescue and Fire Fighting Station Building Design and discussions with the Fire Chief regarding the operating characteristics of the SEA fire department.

If the existing fire station is replaced by a single station, then a site with an area of approximately four acres is required. If the existing fire station is replaced by two stations (e.g., one east-side station and one west-side station), then each site would require approximately two acres.

7.4 Aircraft Ground Run-up Enclosure

A ground run-up enclosure (GRE) is a three-sided structure used to minimize aircraft ground run-up noise generated when maintenance personnel test aircraft engines. There is no GRE at the Airport.

A site of approximately two acres with taxiway access is required for an aircraft ground run up enclosure. We recommend that such a site be identified and included in SAMP.

7.5 Centralized Receiving Warehouse

Goods utilized by the Airport’s concessionaires currently arrive via multiple daily semi-truck deliveries. The trucks enter the Airport through security gates and travel across the apron to reach multiple receiving docks where the goods are unloaded.

A centralized receiving warehouse is required to (1) eliminate unneeded vehicle traffic from the apron, (2) provide a single location for all Airport deliveries, and (3) enhance security by providing a centralized location at which all Airport deliveries are inspected, prior to delivery to the concessionaires.

7.6 Trash, Recycling, and Compost

Trash collecting, recycling, and composting functions are currently accomplished using dumpsters and compactors at several locations in the terminals and on the airfield. The current facilities are at or nearing capacity and have no room to accommodate growth. The operational “work arounds” currently employed to manage the solid waste streams are increasingly difficult, costly, and are generating significant additional waste hauler truck traffic within the Airport Operations Area.

The requirement is for a centralized waste processing facility at which compactors and dumpsters may be dropped off and picked up and waste may be sorted and pre-processed. Such a facility is expected to facilitate the Port's ability to manage the movement of waste, minimize long-term costs, free airfield space for higher and better uses, contribute to more sustainable operations, and keep third-party waste hauling trucks off the airfield.

7.7 Utilities

The Airport's existing utility infrastructure systems (i.e., electrical, mechanical, sanitary sewer, storm water drainage, and industrial waste) are described in Section 7.2.4 of *Technical Memorandum No. 2 Existing Conditions Inventory*. This existing utility infrastructure and the supply of supporting regional infrastructure (e.g., power, water, and sewerage) are generally adequate to meet current and future needs.

The facilities changes needed to permit the Airport to accommodate the forecast PAL 4 (2034) demand of approximately 66 million annual passengers will be extensive as will be the number of projects required to support this growth. The utilities requirements associated with these future projects will be determined by the specifics of each project (e.g., we know that a second passenger terminal, if desired, will require a stand-alone utility plant).

Accordingly, the recommended approach to utilities requirements is to estimate utilities issues and requirements to the extent appropriate for the purposes of cost estimating during the alternatives phase of SAMP and conduct more detailed requirements analyses during detailed planning and design that will follow the SAMP.

There are known requirements for utility system modifications that are currently being planned outside the SAMP (e.g., modifications required to the industrial waste system).

General Aviation

This chapter summarizes the requirements for general aviation facilities through the 20-year planning period.

General aviation (GA) facilities at the airport consist of a corporate aircraft hangar located on a site leased by the Weyerhaeuser Corporation, a fixed base operator (FBO) building, and an adjacent 48,000-square foot (approximate) itinerant aircraft apron owned by the Port. These facilities are located in the southwest quadrant of the Airport as shown on Figure 8-1.

In 2014, the Airport accommodated an average of approximately 11 daily GA operations. In 2016, the number of average daily GA operations decreased to approximately 8 operations. By PAL 4, the average number of daily GA operations is forecast to increase slightly, to approximately 12 daily operations.

Consistent with the Port's philosophy of compliance with FAA grant assurances, it is recommended that the site utilized to accommodate itinerant GA aircraft (i.e., the site accommodating both the FBO building and itinerant GA aircraft apron) be retained; it is adequate to accommodate demand through PAL 4 (2034); no increase in size is recommended. There is no requirement to continue leasing land to the Weyerhaeuser Corporation for its corporate hangar.

Figure 8-1
General Aviation Facilities
Seattle-Tacoma International Airport

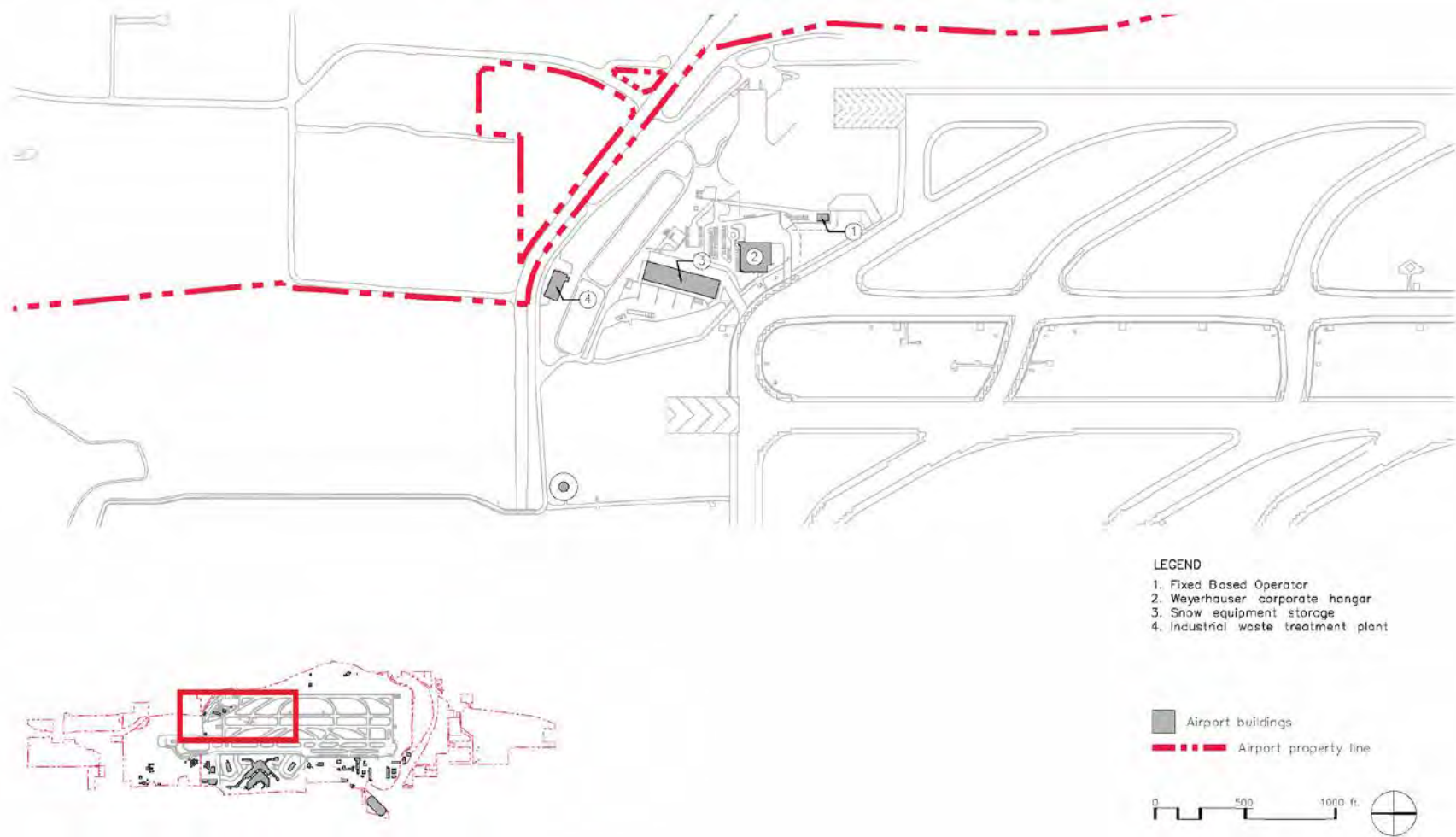

Source: Port of Seattle, 2014.

Appendix A—Approach to Developing Design Day Flight Schedules

Appendix A—Approach to Developing Design Day Flight Schedules

Development of Design Day Future Schedules

This section summarizes the development of design day future schedules (DDFS) for the average day peak month (ADPM) at the Airport for 2014, 2016, 2019, 2024, 2029, and 2034. The forecasts of ADPM aircraft operations and passengers are derived from the annual forecasts presented in the technical memorandum “Forecasts of Aviation Activity”.

Design Day Future Schedules

A DDFS is defined as “a constructed schedule showing individual aircraft arrivals and departures by time of day and aircraft type that can also show airline, O&D, and the number of passengers associated with each flight, depending on the level of detail required.”* For the SEA SAMP, the DDFSs were used to evaluate the requirements for the airfield/airspace and the passenger terminal complex.

Approach

DDFSs represent the level of activity that typically occurs on an average day in the peak month. The historical relationship between annual, peak month, and ADPM activity is evaluated to provide a basis for the selection of a representative week day from published airline schedules, as shown in Figure A-1.

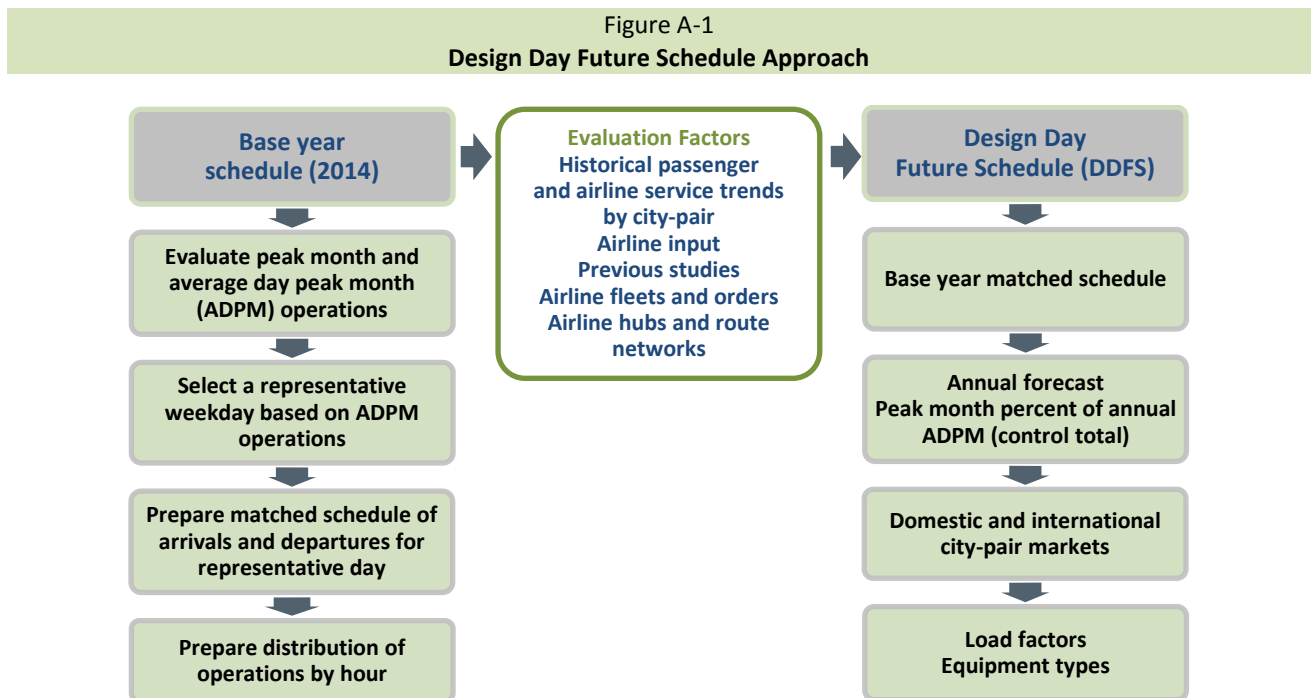

*ACRP Report 163, Guidebook for Preparing and Using Airport Design Day Flight Schedules, 2016.

Average Day Peak Month

In 2014, the peak month (July) accounted for 9.9% of passenger airline operations and 10.2% of passengers, as shown in Table A-1. It was assumed that the peak month would continue to account for the same percentages of annual operations and passengers in future years. ADPM activity, calculated by dividing the peak month by 31 days, represents the “control totals” for the selection of a representative day from published airline schedules in 2014 and for the development of schedules for future years.

Table A-1
Historical and Forecast Peak Period Demand
Seattle-Tacoma International Airport

| | Historical | | Baseline forecast | | | |
|--|------------|------------|-------------------|------------|------------|------------|
| | 2014 | 2016 | 2019 | 2024 | 2029 | 2034 |
| Total passengers (enplaned and deplaned) | | | | | | |
| Annual | 37,498,267 | 45,736,700 | 44,815,200 | 51,827,400 | 58,921,600 | 65,647,200 |
| Peak month | 3,824,823 | 4,665,143 | 4,571,150 | 5,286,395 | 6,010,003 | 6,696,014 |
| Peak month percent of annual | 10.2% | 10.2% | 10.2% | 10.2% | 10.2% | 10.2% |
| Average day peak month (ADPM) | 123,381 | 150,488 | 147,456 | 170,529 | 193,871 | 216,000 |
| Peak hour passengers | 9,928 | 10,657 | 11,021 | 12,106 | 12,938 | 14,132 |
| Passenger airline scheduled aircraft operations (arrivals and departures) | | | | | | |
| Annual operations | 324,372 | 400,000 | 381,100 | 430,300 | 477,820 | 520,400 |
| Peak month | 31,996 | 39,456 | 37,592 | 42,445 | 47,132 | 51,332 |
| Peak month percent of annual | 9.9% | 9.9% | 9.9% | 9.9% | 9.9% | 9.9% |
| Average day peak month (ADPM) | 1,032 | 1,273 | 1,213 | 1,369 | 1,520 | 1,656 |
| Peak hour operations | 88 | 95 | 95 | 102 | 113 | 125 |

Note: The forecasts presented in this table were prepared using the information and assumptions given in the accompanying text. Inevitably, some of the assumptions used to develop the forecasts will not be realized and unanticipated events and circumstances may occur. Therefore, there are likely to be differences between the forecast and actual results, and those differences may be material.

The base year for the forecasts is 2014.

Sources: Historical--Seattle-Tacoma International Airport records and OAG Worldwide Aviation Ltd, online database, accessed August 2014 and September 2016.
Forecast--LeighFisher, September 2014.

Base Year Matched Schedule

A matched schedule of arrivals and departures for 2014 was prepared using LeighFisher’s proprietary software. Arriving and departing flights with the same aircraft type, seat configuration, and airline were matched and evaluated based on reasonable stand times. In addition, a review of airline schedules for 2016 was conducted to evaluate changes related to the development of Delta’s hubbing operations at SEA and the competitive responses by other airlines. As shown in Figure A-2, a comparison of the hourly distribution of flights in the 2014 and 2016 schedules indicates that:

- The 2016 schedule is more peaked than the 2014 schedule
- The morning peak in 2016 occurs earlier in the day
- The valley between 6:00 am and 8:00 am in 2016 has been filled
- The evening peak in 2016 occurs later in the day
- An additional peak or bank occurs at approximately 5:00 pm
- Considerable down time (valleys) is included in the 2016 schedule

In consideration of the changes noted above, the DDFSs were revised to reflect the hourly distribution in the 2016 matched schedule. Figure A-3 shows the hourly distribution of operations in 2016 and the future years.

Figure A-2
Comparison of Rolling Hour Arrivals and Departures in 2014 and 2016
Seattle-Tacoma International Airport

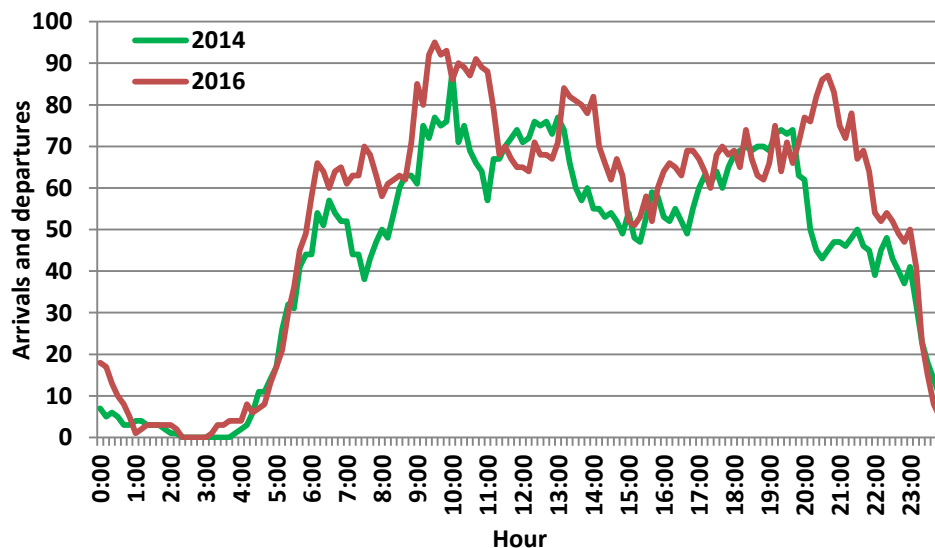

Note: Rolling hour is a 10-minute look ahead.

Source: OAG Worldwide Aviation Ltd, Schedules Analyser, accessed August 2014 and September 2016.

Figure A-3
Historical and Forecast Rolling Hour Arrivals and Departures
 Seattle-Tacoma International Airport

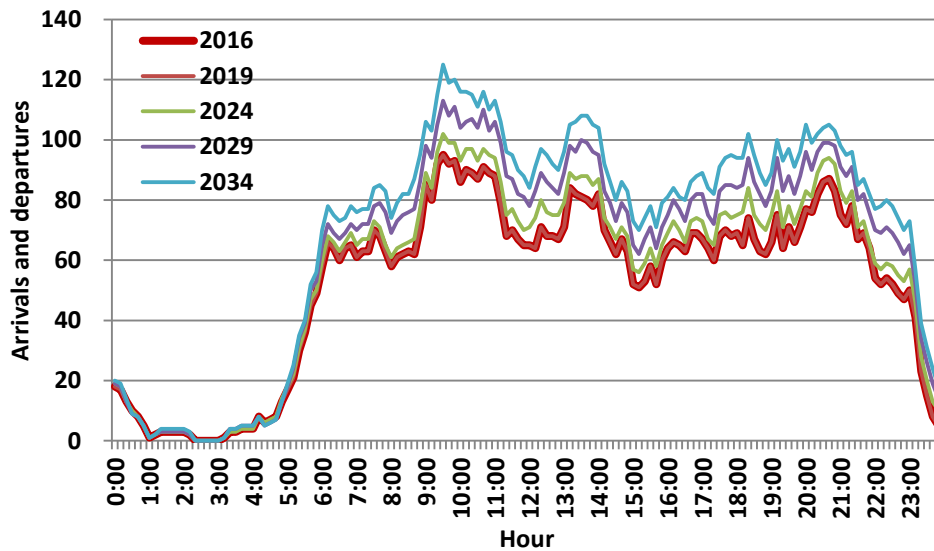

Note: Rolling hour is a 10-minute look ahead.

Sources: 2016—OAG Worldwide Aviation Ltd, Schedules Analyser, accessed September 2016.
 Forecast—LeighFisher, September 2014.

Evaluation Factors

A number of factors were used to evaluate and develop DDFSs for SEA, including:

- A bottom-up analysis of passenger airline service and passenger traffic by city-pair market for domestic and international sectors
- Analyses conducted in previous studies for NorthStar and the International Arrivals Facility
- Input from airlines, the Port of Seattle air service department, and other stakeholders
- Airline fleets and aircraft orders, including the average age of existing aircraft, estimated useful lives, and the timing of aircraft deliveries
- Airline hubs, route networks, and banking patterns

Appendix B—Working Paper – Gate Requirements Summary

Leigh|Fisher



Gate Requirements Summary

Sustainable Airport Master Plan

Prepared for:
Port of Seattle

June 2, 2015

CONTENTS

Approach to Estimating Gate Requirements 1
Gate Model Assumptions 3

TABLES

1 Minimum Arrival and Departure Times (Minutes)..... 4
2 Buffer and Turn Times (Minutes) 4
3 Existing Gate and Off-Gate Parking Inventory 5
4 Aircraft Gate and Parking Requirements – 2019 5
5 Aircraft Gate and Parking Requirements – 2024 5
6 Aircraft Gate and Parking Requirements – 2029 6
7 Aircraft Gate and Parking Requirements – 2034 6
8 Incremental Gate Requirements – 2019, 2024, 2029, and 2034 7

FIGURES

1 Illustration of Mix A – Maximum Aircraft Mix 8
2 Illustration of Mix B – Maximum Widebody Mix 9

APPENDICES

- 2019 Ramp Chart
- 2024 Ramp Chart
- 2029 Ramp Chart
- 2034 Ramp Chart

APPROACH TO ESTIMATING GATE REQUIREMENTS

- In this document, the term “gate” refers to an aircraft parking position
 - A contact gate is an aircraft parking position equipped with a passenger boarding bridge connected to the passenger terminal
 - An “off-gate” parking position is typically located away from, but relatively near to contact gates and is also known as a hardstand or remain overnight aircraft parking position
- Contact gate requirements and off-gate aircraft parking requirements were estimated for 2019, 2024, 2029, and 2034 (Planning Activity Levels (PAL) 1, 2, 3, and 4, respectively)
- Estimating tool was LeighFisher’s gate model; inputs to gate model included:
 - Planning day flight schedules developed for each PAL (schedules included aircraft type, arrival time, and departure time for each scheduled flight)
 - Buffer time required between scheduled gate activity (refer to attached gate model assumptions and Tables 1 and 2)
 - Rules related to gate sharing among airlines (sharing is always permitted within the groups of activity described below, sharing between groups is permitted on an exception basis)
 - Rules governing aircraft towing to and from remain overnight and off-gate parking positions (all towing operations are estimated to require 15 minutes)
- Contact gate requirements were estimated for four groups of activity that reflect differing requirements to be included in the long-range development plan
 - **International** gates were grouped because of the requirement that each be connected to the FIS facilities by a sterile corridor and the need to prioritize their use for international arrivals
 - **Delta domestic** gates were grouped because of Delta’s increasing volume of activity on the south half of the Airport and the relationship of its domestic network to its growing international hub
 - **Alaska Air Group** gates were grouped because of the Group’s market share at the Airport (greater than 50%) and dominant position
 - **Other domestic** gates were grouped as a logical consequence of the three primary groups
- Off-gate aircraft parking requirements were estimated for two groups of activity that reflect a potential split between requirements for the south and north Airport)
 - International and Delta domestic
 - Other domestic
- Gate requirements are summarized graphically in “ramp charts” (i.e., Gantt charts) produced by the gate model

- Approach ensures the estimated requirements represent the minimum number of new gates (i.e., aircraft parking positions) needed to accommodate the scheduled activity
 - Gate requirements were unconstrained by existing infrastructure (e.g., gate requirements were estimated by gating aircraft based on model inputs and the capabilities of parking positions created by the model; existing restrictions related to geometry, passenger boarding bridges, or ramp striping were not considered)
 - Maximum gate sharing
 - Benchmark comparison against existing gate inventory
- The number of gates required to accommodate a given schedule is not a single number, but a range of numbers. The number of gates required can vary depending on factors such as fleet mix, the allowance provided for off-schedule operations, gate sharing

GATE MODEL ASSUMPTIONS

Minimum Arrival and Departure Times

Assumptions for the minimum duration of time required on gate to process arrival and departure operations are shown in Table 1. These are the amounts of time that an aircraft occupies a gate to complete an arrival or a departure operation, respectively.

Earliness and Lateness Buffers

Earliness and lateness buffers allow for schedule variability by reserving blocks of gate time for flights that may be early or late relative to schedule. In the Gate Model all flights are assumed to arrive and depart on schedule. These buffers provide a time “cushion” between successive gate operations. The earliness and lateness buffers used for international flights were derived by analyzing historic operations data for SEA. The earliness and lateness buffers shown in Table 2 represent the 85th percentile values for arrival time variance; i.e., 85 percent of the time the flight arrives within the span of time given by: (Scheduled Arrival Time -Earliness Buffer) + (Scheduled Arrival Time + Lateness Buffer).

Minimum Turn Times

The assumed minimum time on gate to turn an aircraft, i.e., the minimum time to unload arriving passengers, exchange baggage, refuel, cater, and load departing passengers in quick succession, is shown in Table 2. In the Gate Model, aircraft with scheduled ground times less than or equal to the minimum turn time will have a full lateness buffer applied after the scheduled departure time. Aircraft with scheduled ground times greater than the minimum turn time will have either a shortened lateness buffer or no lateness buffer applied depending on how much “slack” is provided in their scheduled ground time.

Maneuver Buffer

The assumed amount of time that a gate is unavailable while aircraft and equipment are maneuvered into and out of position is shown in Table 2. In the Gate Model, a maneuver buffer is applied after each departure from a gate.

Aircraft Towing

The Gate Model permits aircraft with scheduled ground times significantly greater than the sum of the minimum arrival and minimum departure times to be towed and parked remotely in order to make gates available for active operations. “Significantly greater” is defined as 45 minutes.

All aircraft towing operations to move an idle aircraft to a remote position or another gate from its starting position are allotted 15 minutes. Similarly, an aircraft towing operation from a remote position to an active gate for departure is also allotted 15 minutes.

Table 1
Minimum Arrival and Departure Times (Minutes)

| Aircraft Seats | Arrival | Departure |
|----------------|-------------------------------------|-------------------------------------|
| 400+ | NA | NA |
| 200-399 | 45 (domestic) 60 (international) | 45 (domestic) 60 (international) |
| 100-199 | 30 (domestic) 60 (international) | 30 (domestic) 60 (international) |
| 0-99 | 25 | 25 |

Table 2
Buffer and Turn Times (Minutes)

| Region | Earliness Buffer | Lateness Buffer | Maneuver Buffer |
|----------|------------------|-----------------|-----------------|
| Asia | 43 | 42 | 10 |
| Canada | 21 | 10 | 10 |
| Europe | 37 | 30 | 10 |
| Mexico | 10 | 10 | 10 |
| Domestic | 10 | 10 | 5 |

TABLE 3
EXISTING GATE AND OFF-GATE PARKING INVENTORY

Summary of detailed inventory on tab 'Positions'

| POSITION TYPE Sector Location | Mix A (b) | | | | | | Mix B (b) | | | | | |
|-------------------------------------|------------------------|-----------|-----------|----------|----------|-----------|------------------------|-----------|-----------|-----------|----------|-----------|
| | Aircraft size category | | | | | Total | Aircraft size category | | | | | Total |
| | RJ/TP | Jet III | Jet IV | Jet V | Jet VI | Mix A | RJ/TP | Jet III | Jet IV | Jet V | Jet VI | Mix B |
| GATES (a) | | | | | | | | | | | | |
| International | 1 | 1 | 6 | 5 | 2 | 15 | 1 | - | 2 | 8 | 2 | 13 |
| Domestic | 26 | 31 | 18 | 2 | - | 77 | 20 | 32 | 12 | 6 | - | 70 |
| TOTAL GATES | 27 | 32 | 24 | 7 | 2 | 92 | 21 | 32 | 14 | 14 | 2 | 83 |

Notes

(a) Parking positions that can accommodate loading/unloading of passenger airline aircraft.

(b) The number positions that can be simultaneously occupied on a given ramp area may vary based on configuration and layout. Flexibly configured aprons can accommodate various discrete combinations of small and large aircraft. 'Mix A' presents the upper bound of the number of aircraft that can be accommodated assuming the smallest aircraft size mix and 'Mix B' presents the lower bound assuming the largest aircraft size mix.

TABLE 4
AIRCRAFT GATE AND PARKING REQUIREMENTS - 2019

Gate Model results assuming no infrastructure constraints

Based on the 2019 ramp chart

Comparable with Mix B of existing gate inventory

| POSITION TYPE Sector or Activity Description Activity group | Aircraft size category | | | | | Total |
|---|------------------------|-----------|-----------|-----------|----------|-----------|
| | RJ/TP | Jet III | Jet IV | Jet V | Jet VI | |
| | GATES (a) | | | | | |
| International | - | - | 2 | 16 | - | 18 |
| Domestic | 19 | 47 | 10 | 1 | - | 77 |
| TOTAL GATES | 19 | 47 | 12 | 17 | - | 95 |
| OFF-GATE PARKING | | | | | | |
| Total Demand | 6 | 31 | 5 | 4 | - | 46 |
| Demand accommodated at gates (b) | 5 | 11 | 2 | - | - | 18 |
| NET OFF-GATE PARKING REQUIREMENT | 1 | 20 | 3 | 4 | - | 28 |

GATE / OFF-GATE PARKING RATIO 3.4
TOTAL GATE + OFF-GATE POSITIONS 123

Notes

(a) Includes all activity by foreign flag carriers (except Air Canada) and international arrivals by Alaska Air Group and Delta.

(b) Off-gate parking demand that could be accommodated on available gates as determined by visual inspection of Gate Model ramp charts.

TABLE 5
AIRCRAFT GATE AND PARKING REQUIREMENTS - 2024

Gate Model results assuming no infrastructure constraints

Based on the 2024 ramp chart

Comparable with Mix B of existing gate inventory

| POSITION TYPE Sector or Activity Description Activity group | Aircraft size category | | | | | Total |
|---|------------------------|-----------|-----------|-----------|----------|------------|
| | RJ/TP | Jet III | Jet IV | Jet V | Jet VI | |
| | GATES (a) | | | | | |
| International | - | 1 | 2 | 19 | - | 22 |
| Domestic | 21 | 50 | 10 | 1 | - | 82 |
| TOTAL GATES | 21 | 51 | 12 | 20 | - | 104 |
| OFF-GATE PARKING | | | | | | |
| Total Demand | 7 | 38 | 4 | 3 | - | 52 |
| Demand accommodated at gates (b) | 5 | 16 | - | - | - | 21 |
| NET OFF-GATE PARKING REQUIREMENT | 2 | 22 | 4 | 3 | - | 31 |

GATE / OFF-GATE PARKING RATIO 3.4
TOTAL GATE + OFF-GATE POSITIONS 135

Notes

(a) Includes all activity by foreign flag carriers (except Air Canada) and international arrivals by Alaska Air Group and Delta.

(b) Off-gate parking demand that could be accommodated on available gates as determined by visual inspection of Gate Model ramp charts.

TABLE 6
AIRCRAFT GATE AND PARKING REQUIREMENTS - 2029

Gate Model results assuming no infrastructure constraints

Based on the 2029 ramp chart

Comparable with Mix B of existing gate inventory

| POSITION TYPE Sector or Activity Description Activity group | Aircraft size category | | | | | Total |
|---|------------------------|-----------|-----------|-----------|----------|------------|
| | RJ/TP | Jet III | Jet IV | Jet V | Jet VI | |
| GATES (a) | | | | | | |
| International | - | - | 2 | 22 | - | 24 |
| Domestic | 21 | 51 | 8 | 2 | - | 82 |
| TOTAL GATES | 21 | 51 | 10 | 24 | - | 106 |
| OFF-GATE PARKING | | | | | | |
| Total Demand | 7 | 42 | 6 | 4 | - | 59 |
| Demand accommodated at gates (b) | 4 | 15 | 3 | - | - | 22 |
| NET OFF-GATE PARKING REQUIREMENT | 3 | 27 | 3 | 4 | - | 37 |

GATE / OFF-GATE PARKING RATIO 2.9
TOTAL GATE + OFF-GATE POSITIONS 143

Notes

(a) Includes all activity by foreign flag carriers (except Air Canada) and international arrivals by Alaska Air Group and Delta.

(b) Off-gate parking demand that could be accommodated on available gates as determined by visual inspection of Gate Model ramp charts.

TABLE 7
AIRCRAFT GATE AND PARKING REQUIREMENTS - 2034

Gate Model results assuming no infrastructure constraints

Based on the 2034 ramp chart

Comparable with Mix B of existing gate inventory

| POSITION TYPE Sector or Activity Description Activity group | Aircraft size category | | | | | Total |
|---|------------------------|-----------|----------|-----------|----------|------------|
| | RJ/TP | Jet III | Jet IV | Jet V | Jet VI | |
| GATES (a) | | | | | | |
| International | - | 2 | - | 27 | - | 29 |
| Domestic | 12 | 63 | 6 | 3 | - | 84 |
| TOTAL GATES | 12 | 65 | 6 | 30 | - | 113 |
| OFF-GATE PARKING | | | | | | |
| Total Demand | 7 | 47 | 5 | 7 | - | 66 |
| Demand accommodated at gates (b) | 3 | 17 | 2 | - | - | 22 |
| NET OFF-GATE PARKING REQUIREMENT | 4 | 30 | 3 | 7 | - | 44 |

GATE / OFF-GATE PARKING RATIO 2.6
TOTAL GATE + OFF-GATE POSITIONS 157

Notes

(a) Includes all activity by foreign flag carriers (except Air Canada) and international arrivals by Alaska Air Group and Delta.

(b) Off-gate parking demand that could be accommodated on available gates as determined by visual inspection of Gate Model ramp charts.





Table 8
INCREMENTAL GATE REQUIREMENTS - 2019, 2024, 2029, and 2034

| Existing Gate Inventory | | | | 2019 Requirements | | | | | | Existing Gate Inventory | | | | 2024 Requirements | | | | | |
|-----------------------------|----------------|-----|-----------------|-----------------------|-----|-------|-----------------------------|-----|-------|-----------------------------|----------------|-----|-------|-----------------------|-----|-------|-----------------------------|-----|-------|
| Widebody Mix B ^a | | | | Absolute ^b | | | Incremental (over existing) | | | Widebody Mix B ^a | | | | Absolute ^b | | | Incremental (over existing) | | |
| | Int | Dom | Total | Int | Dom | Total | Int | Dom | Total | | Int | Dom | Total | Int | Dom | Total | Int | Dom | Total |
| RJ/TP | 1 ^c | 20 | 20 | - | 19 | 19 | - | - | - | RJ/TP | 1 ^c | 20 | 20 | - | 21 | 21 | - | 1 | 1 |
| Jet III | - | 32 | 32 | - | 47 | 47 | - | 15 | 15 | Jet III | - | 32 | 32 | 1 | 50 | 51 | 1 | 18 | 19 |
| Jet IV | 2 | 12 | 14 | 2 | 10 | 12 | - | (2) | (2) | Jet IV | 2 | 12 | 14 | 2 | 10 | 12 | - | (2) | (2) |
| Jet V | 8 | 6 | 14 | 16 | 1 | 17 | 8 | (5) | 3 | Jet V | 8 | 6 | 14 | 19 | 1 | 20 | 11 | (5) | 6 |
| Jet VI | 2 | 0 | 2 | - | - | - | (2) | - | (2) | Jet VI | 2 | 0 | 2 | - | - | - | (2) | - | (2) |
| Total | 12 | 70 | 82 ^d | 18 | 77 | 95 | 6 | 8 | 14 | Total | 12 | 70 | 82 | 22 | 82 | 104 | 10 | 12 | 22 |

| Existing Gate Inventory | | | | 2029 Requirements | | | | | | Existing Gate Inventory | | | | 2034 Requirements | | | | | |
|-----------------------------|----------------|-----|-------|-----------------------|-----|-------|-----------------------------|-----|-------|-----------------------------|----------------|-----|-----------------|-----------------------|-----|-------|-----------------------------|------------------|------------------|
| Widebody Mix B ^a | | | | Absolute ^b | | | Incremental (over existing) | | | Widebody Mix B ^a | | | | Absolute ^b | | | Incremental (over existing) | | |
| | Int | Dom | Total | Int | Dom | Total | Int | Dom | Total | | Int | Dom | Total | Int | Dom | Total | Int | Dom | Total |
| RJ/TP | 1 ^c | 20 | 20 | - | 21 | 21 | - | 1 | 1 | RJ/TP | 1 ^c | 20 | 20 | - | 12 | 12 | - | (4) ^e | (4) ^e |
| Jet III | - | 32 | 32 | - | 51 | 51 | - | 19 | 19 | Jet III | - | 32 | 32 | 2 | 63 | 65 | 2 | 31 | 33 |
| Jet IV | 2 | 12 | 14 | 2 | 8 | 10 | - | (4) | (4) | Jet IV | 2 | 12 | 14 | - | 6 | 6 | (2) | (6) | (8) |
| Jet V | 8 | 6 | 14 | 22 | 2 | 24 | 14 | (4) | 10 | Jet V | 8 | 6 | 14 | 27 | 3 | 30 | 19 | (3) | 16 |
| Jet VI | 2 | 0 | 2 | - | - | - | (2) | - | (2) | Jet VI | 2 | 0 | 2 | - | - | - | (2) | - | (2) |
| Total | 12 | 70 | 82 | 24 | 82 | 106 | 12 | 12 | 24 | Total | 12 | 70 | 82 ^e | 29 | 84 | 113 | 17 | 18 | 35 |

- a. The number of aircraft that can be accommodated on the Airport's existing gates depends on the number of widebody aircraft included in the mix.
- Mix A is the mix that yields the maximum number of aircraft.
 - Mix B is the mix that yields the maximum number of widebody aircraft.
- The gate count shown excludes one RJ position at the South Satellite.
- b. Source: Redacted gate charts
- c. One existing international RJ position was not counted in the current total since it cannot be used to accommodate any aircraft during future planning periods.
- d. One RJ position is not needed in the 2019 requirements, so the total usable number of positions (as seen in the 2019 Gantt Chart) is 81 instead of 82.
- e. Eight RJ positions are unneeded in the 2034 forecast and can be replaced with 4 Jet III positions. The 8 unneeded positions are the southernmost Concourse C gates (Q1 - Q8). Therefore, the total usable number of positions (as seen in the 2034 Gantt Chart) is 78 instead of 82.

LEGEND

-  Jet VI
-  Jet V
-  Jet IV
-  Jet III
-  Jet RJ/P

| Location | Aircraft size category | | | | | Total |
|--------------------|------------------------|-----------|-----------|----------|----------|-----------|
| | RJ/TP | Jet III | Jet IV | Jet V | Jet VI | |
| International | | | | | | |
| South Satellite | 1 | 1 | 6 | 5 | 2 | 15 |
| Domestic | | | | | | |
| Concourse A | 2 | 4 | 7 | 2 | | 15 |
| Concourse B | 1 | 5 | 7 | | | 13 |
| Concourse C | 14 | 5 | | | | 19 |
| Concourse D | | 5 | 4 | | | 9 |
| North Satellite | 5 | 10 | | | | 15 |
| Subtotal | 25 | 32 | 18 | 2 | | 77 |
| TOTAL GATES | 27 | 32 | 24 | 7 | 2 | 92 |



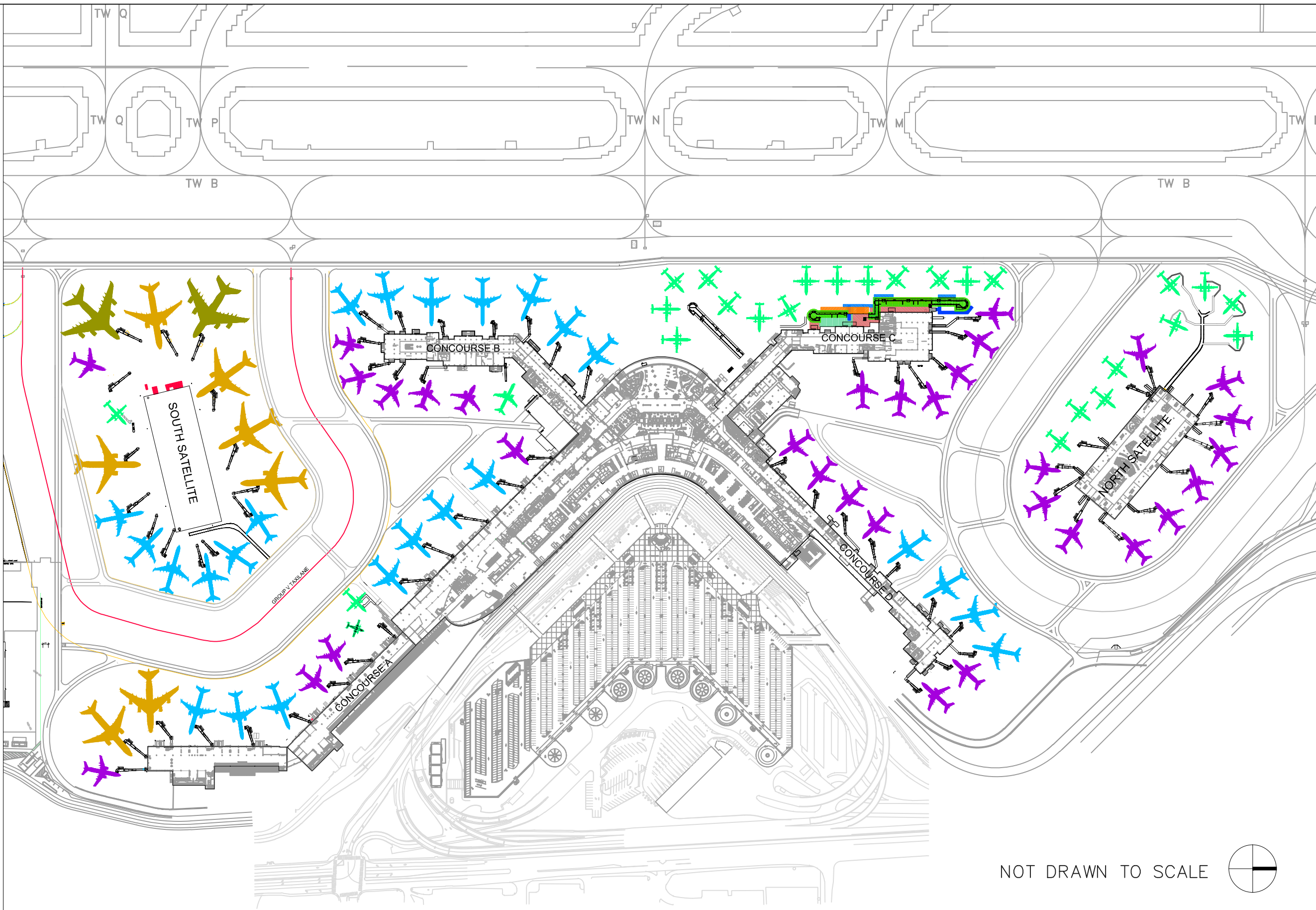

Note: The number of aircraft that can be accommodated on the available ramp varies based on factors including facilities, operating practice, and aircraft mix. "Mix A" represents an upper bound of the number of aircraft assuming fewer widebody aircraft.

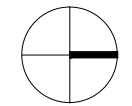

NOT DRAWN TO SCALE



LEGEND

-  Jet VI
-  Jet V
-  Jet IV
-  Jet III
-  Jet RJ/P

| Location | Aircraft size category | | | | | Total |
|--------------------|------------------------|-----------|-----------|-----------|----------|-----------|
| | RJ/TP | Jet III | Jet IV | Jet V | Jet VI | |
| International | | | | | | |
| South Satellite | 1 | - | 2 | 8 | 2 | 13 |
| Domestic | | | | | | |
| Concourse A | | 3 | 5 | 4 | | 12 |
| Concourse B | 1 | 3 | 5 | 2 | | 11 |
| Concourse C | 14 | 6 | | | | 20 |
| Concourse D | | 6 | 4 | | | 10 |
| North Satellite | 3 | 12 | | | | 15 |
| Subtotal | 20 | 32 | 12 | 6 | - | 70 |
| TOTAL GATES | 21 | 32 | 14 | 14 | 2 | 83 |

Note: The number of aircraft that can be accommodated on the available ramp varies based on factors including facilities, operating practice, and aircraft mix. "Mix B" represents a lower bound of the number of aircraft assuming a maximum number of wide body aircraft.

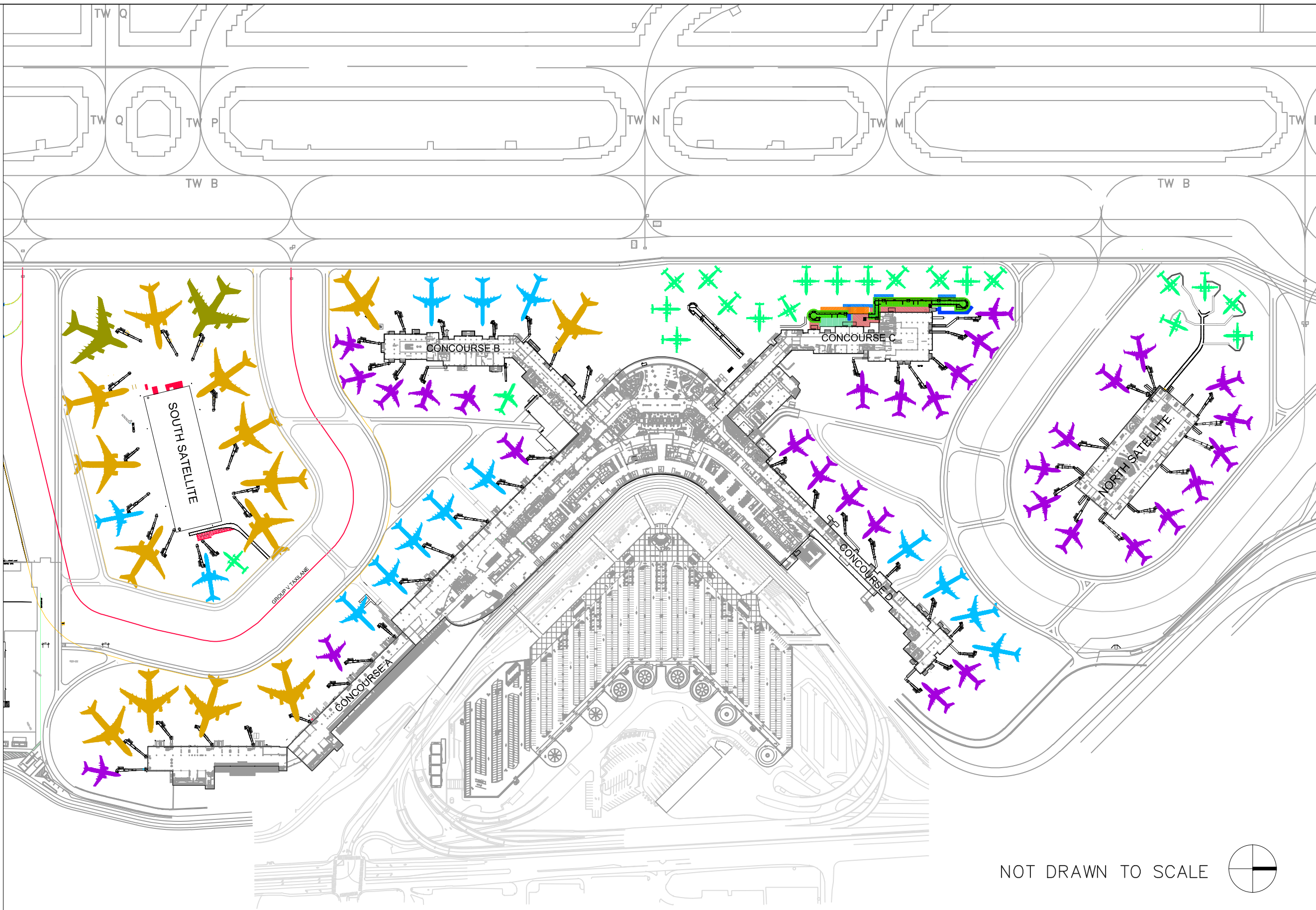

NOT DRAWN TO SCALE

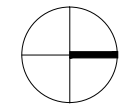

APPENDICES

2019 Ramp Chart

| Position | Based on 'Mix B' assuming the largest aircraft size mix | Jet Type | Jet Type Count | Max Wingspan Acft | Max Length Acft |
|----------|---|----------|----------------|-------------------|-----------------|
| INT 1 | Existing | V | 1 | B-777-300ER | |
| INT 2 | Existing | V | 2 | B-777-300ER | |
| INT 3 | Existing | V | 3 | B-777-300ER | |
| INT 4 | Existing | V | 4 | B-777-300ER | |
| INT 5 | Existing | V | 5 | B-777-300ER | |
| INT 6 | Existing | V | 6 | B-777-300ER | |
| INT 7 | Existing | V | 7 | B-777-300ER | |
| INT 8 | Existing | V | 8 | B-777-300ER | |
| INT 9 | Existing | V | 9 | B-777-300ER | |
| INT 10 | Existing | V | 10 | B-777-300ER | |
| INT 11 | New | | | B-777-300ER | |
| INT 12 | New | | | B-777-300ER | |
| INT 13 | New | | | B-777-300ER | |
| INT 14 | New | | | B-777-300ER | |
| INT 15 | New | | | B-777-300ER | |
| INT 16 | New | | | B-777-300ER | |
| INT 17 | Existing | IV | 1 | B-767-300ERWL | |
| INT 18 | Existing | IV | 2 | B-767-300ERWL | |

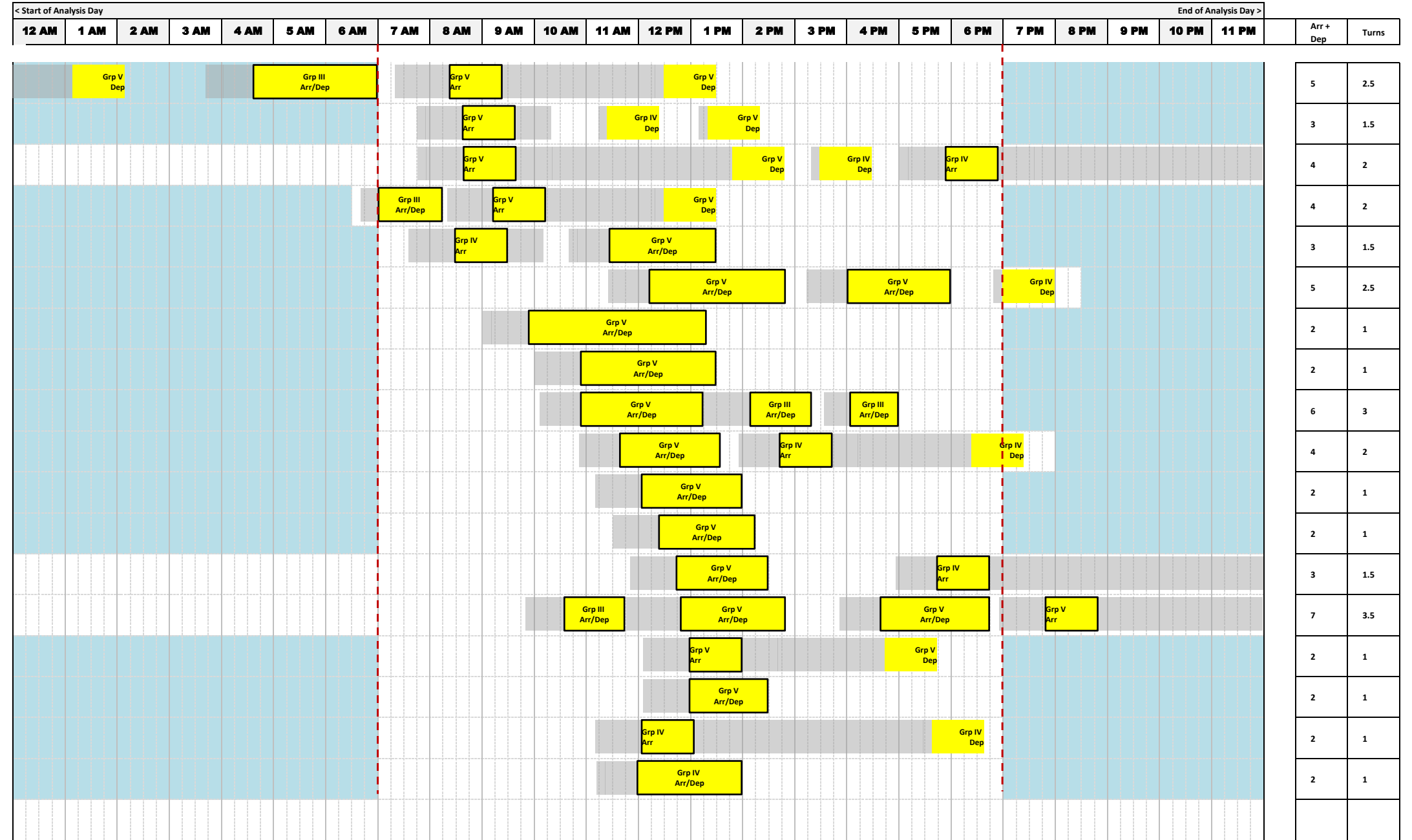

2019 Ramp Chart

| Position | Based on 'Mix B' assuming the largest aircraft size mix | Jet Type | Jet Type Count | Max Wingspan Acft | Max Length Acft |
|----------|---|----------|----------------|-------------------|-----------------|
| DOM 1 | Existing | IV | 1 | B-767-300ERWL | |
| DOM 2 | Existing | IV | 2 | B-767-300ERWL | |
| DOM 3 | Existing | IV | 3 | B-767-300ERWL | |
| DOM 4 | Existing | IV | 4 | B-767-300ERWL | |
| DOM 5 | Existing | IV | 5 | B-767-300ERWL | |
| DOM 6 | Existing | IV | 6 | B-767-300ERWL | |
| DOM 7 | Existing | III | 1 | B-737-900WL | MD-80 |
| DOM 8 | Existing | III | 2 | B-737-900WL | MD-80 |
| DOM 9 | Existing | III | 3 | B-737-900WL | MD-80 |
| DOM 10 | Existing | III | 4 | B-737-900WL | MD-80 |
| DOM 11 | Existing | III | 5 | B-737-900WL | MD-80 |
| DOM 12 | Existing | III | 6 | B-737-900WL | MD-80 |
| DOM 13 | Existing | RJ | 1 | E-190 | CRJ-900 |
| DOM 14 | Existing | RJ | 2 | E-190 | CRJ-900 |
| DOM 15 | Existing | RJ | 3 | E-190 | CRJ-900 |
| DOM 16 | Existing | RJ | 4 | E-190 | CRJ-900 |
| DOM 17 | Existing | RJ | 5 | E-190 | CRJ-900 |
| DOM 18 | Existing | RJ | 6 | E-190 | CRJ-900 |
| DOM 19 | Existing | RJ | 7 | E-190 | CRJ-900 |
| DOM 20 | Existing | RJ | 8 | E-190 | CRJ-900 |
| DOM 21 | Existing | RJ | 9 | E-190 | CRJ-900 |

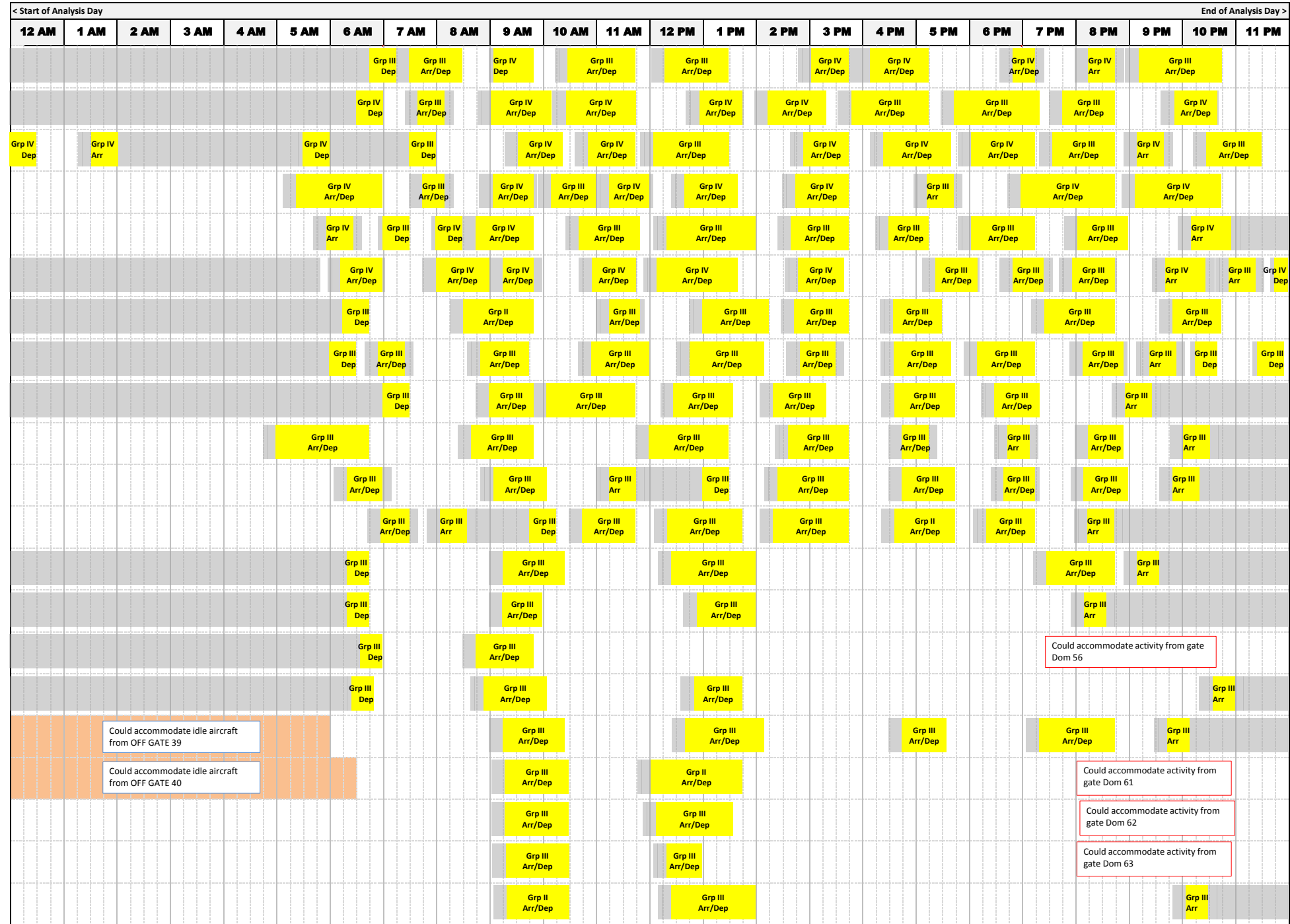

| Arr + Dep | Turns |
|-----------|-------|
| 17 | 8.5 |
| 19 | 9.5 |
| 21 | 10.5 |
| 19 | 9.5 |
| 18 | 9 |
| 21 | 10.5 |
| 15 | 7.5 |
| 20 | 10 |
| 14 | 7 |
| 14 | 7 |
| 15 | 7.5 |
| 15 | 7.5 |
| 8 | 4 |
| 6 | 3 |
| 3 | 1.5 |
| 6 | 3 |
| 9 | 4.5 |
| 4 | 2 |
| 4 | 2 |
| 4 | 2 |
| 5 | 2.5 |

2019 Ramp Chart

| Position | Based on 'Mix B' assuming the largest aircraft size mix | Jet Type | Jet Type Count | Max Wingspan Acft | Max Length Acft |
|----------|---|----------|----------------|-------------------|-----------------|
| DOM 48 | Existing | RJ | 10 | E-190 | CRJ-900 |
| DOM 49 | Existing | RJ | 11 | E-190 | CRJ-900 |
| DOM 50 | Existing | RJ | 12 | E-190 | CRJ-900 |
| DOM 51 | Existing | RJ | 13 | E-190 | CRJ-900 |
| DOM 52 | Existing | RJ | 14 | E-190 | CRJ-900 |
| DOM 53 | Existing | RJ | 15 | E-190 | CRJ-900 |
| DOM 54 | Existing | RJ | 16 | E-190 | CRJ-900 |
| DOM 55 | Existing | RJ | 17 | E-190 | CRJ-900 |
| DOM 56 | Not Needed | | | E-190 | CRJ-900 |
| DOM 57 | Not Needed | | | E-190 | CRJ-900 |
| DOM 58 | Existing | RJ | 18 | E-190 | CRJ-900 |
| DOM 59 | Existing | RJ | 19 | E-190 | CRJ-900 |
| DOM 60 | Not Needed | | | E-190 | CRJ-900 |
| DOM 61 | Not Needed | | | E-190 | CRJ-900 |
| DOM 62 | Not Needed | | | E-190 | CRJ-900 |
| DOM 63 | Not Needed | | | E-190 | CRJ-900 |
| DOM 64 | Existing | V | 1 | B-777-300ER | |
| DOM 65 | Existing | IV | 7 | B-767-300ERWL | |
| DOM 66 | Existing | IV | 8 | B-767-300ERWL | |
| DOM 67 | Existing | IV | 9 | B-767-300ERWL | |
| DOM 68 | Existing | IV | 10 | B-767-300ERWL | |

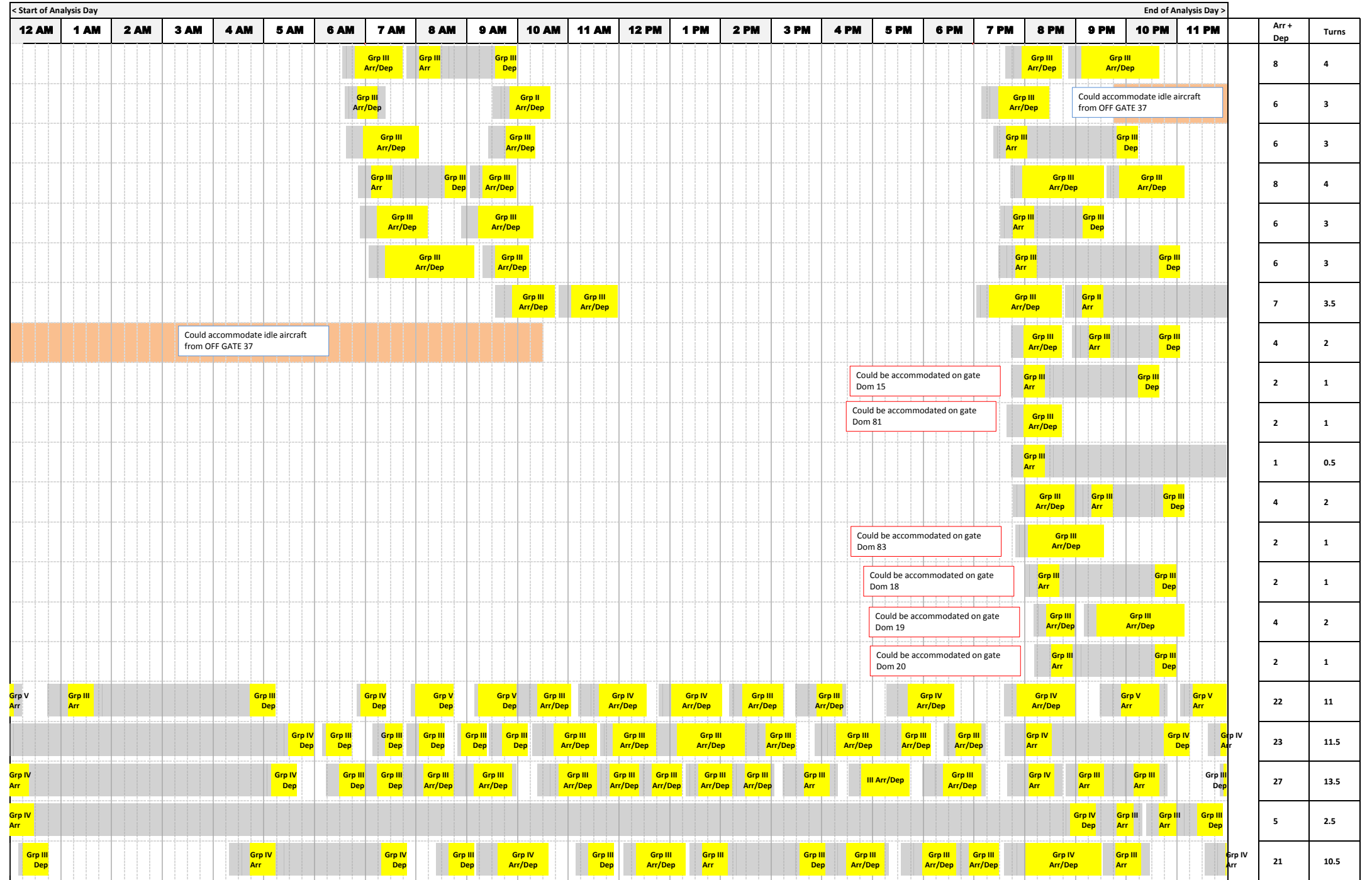

2019 Ramp Chart

| Position | Based on 'Mix B' assuming the largest aircraft size mix | Jet Type | Jet Type Count | Max Wingspan Acft | Max Length Acft |
|----------|---|----------|----------------|-------------------|-----------------|
| DOM 69 | Existing | III | 33 | B-737-900WL | MD-80 |
| DOM 70 | Existing | III | 34 | B-737-900WL | MD-80 |
| DOM 71 | Existing | III | 35 | B-737-900WL | MD-80 |
| DOM 72 | Existing | III | 36 | B-737-900WL | MD-80 |
| DOM 73 | Existing | III | 37 | B-737-900WL | MD-80 |
| DOM 74 | Existing | III | 38 | B-737-900WL | MD-80 |
| DOM 75 | Existing | III | 39 | B-737-900WL | MD-80 |
| DOM 76 | New | | | B-737-900WL | MD-80 |
| DOM 77 | New | | | B-737-900WL | MD-80 |
| DOM 78 | New | | | B-737-900WL | MD-80 |
| DOM 79 | New | | | B-737-900WL | MD-80 |
| DOM 80 | New | | | B-737-900WL | MD-80 |
| DOM 81 | New | | | B-737-900WL | MD-80 |
| DOM 82 | New | | | B-737-900WL | MD-80 |
| DOM 83 | New | | | B-737-900WL | MD-80 |

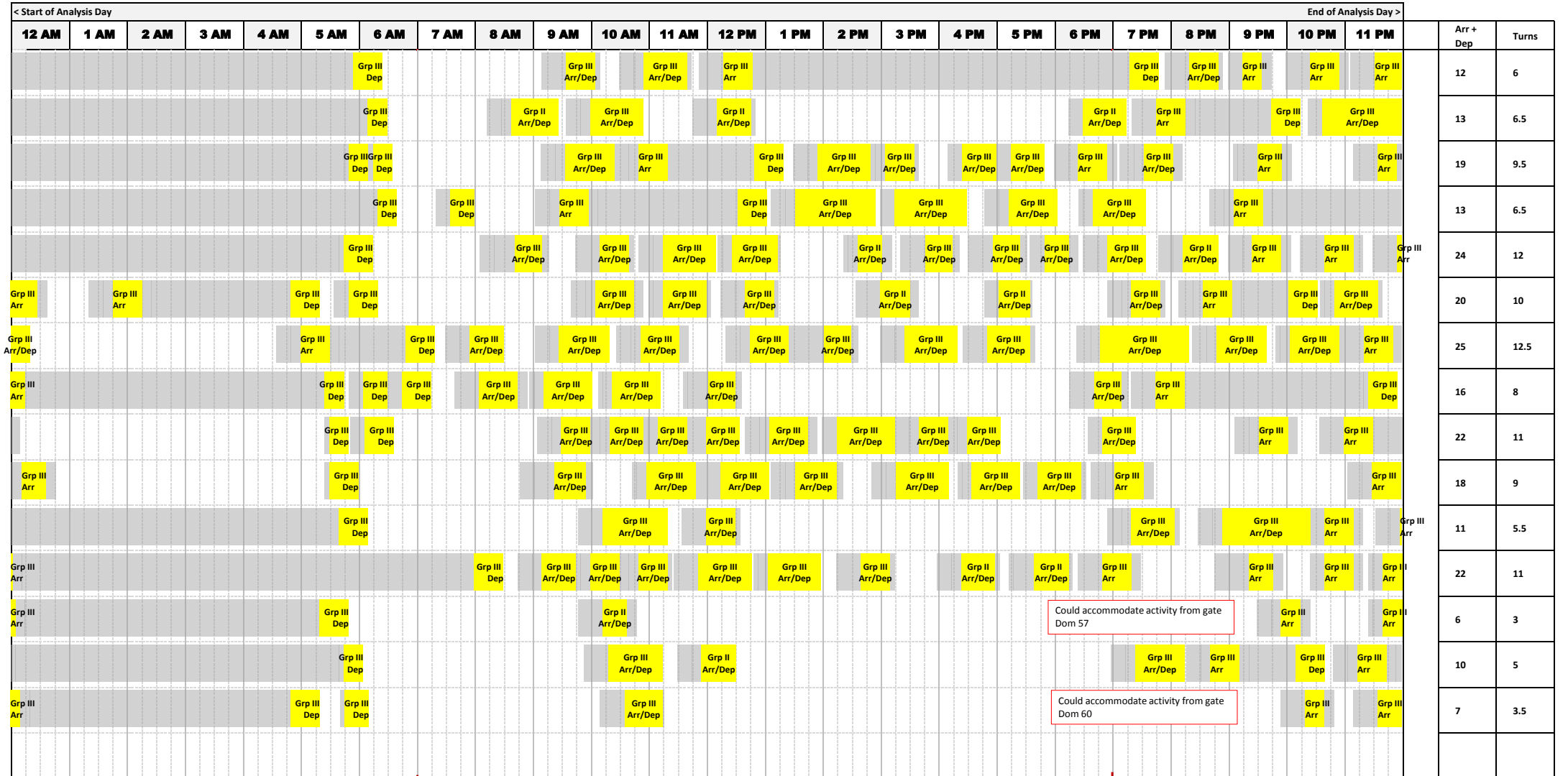

2019 Ramp Chart

| Position | Based on 'Mix B' assuming the largest aircraft size mix | Jet Type | Jet Type Count | Max Wingspan Acft | Max Length Acft | < Start of Analysis Day > | | | | | | | | | | | | | | | | End of Analysis Day > | | | | | Arr + Dep | Turns |
|-------------|---|----------|----------------|-------------------|-----------------|---------------------------|-----------------|------|------|------|------|------|------|------|------|-------|-------|-------|------|------|------|-----------------------|------|------|------|------|-----------|-------|
| | | | | | | 12 AM | 1 AM | 2 AM | 3 AM | 4 AM | 5 AM | 6 AM | 7 AM | 8 AM | 9 AM | 10 AM | 11 AM | 12 PM | 1 PM | 2 PM | 3 PM | 4 PM | 5 PM | 6 PM | 7 PM | 8 PM | | |
| OFF GATE 1 | RON Offgate | | | B-777-300ER | | Grp V Arr/Dep | | | | | | | | | | | | | | | | Grp V Arr/Dep | 2 | 1 | | | | |
| OFF GATE 2 | RON Offgate | | | B-777-300ER | | Grp V Arr/Dep | | | | | | | | | | | | | | | | | 2 | 1 | | | | |
| OFF GATE 3 | RON FIS Gate | | | B-767-300ERWL | | Grp IV Arr/Dep | | | | | | | | | | | | | | | | Grp IV Arr/Dep | 2 | 1 | | | | |
| OFF GATE 4 | RON Offgate | | | B-767-300ERWL | | Grp III Arr/Dep | | | | | | | | | | | | | | | | Grp III Arr/Dep | 4 | 2 | | | | |
| OFF GATE 5 | RON Offgate | | | B-737-900WL | MD-80 | Grp III Arr/Dep | | | | | | | | | | | | | | | | Grp III Arr/Dep | 4 | 2 | | | | |
| OFF GATE 6 | RON Offgate | | | B-737-900WL | MD-80 | Grp III Arr/Dep | | | | | | | | | | | | | | | | Grp III Arr/Dep | 4 | 2 | | | | |
| OFF GATE 7 | RON Offgate | | | B-737-900WL | MD-80 | Grp III Arr/Dep | | | | | | | | | | | | | | | | Grp III Arr/Dep | 2 | 1 | | | | |
| OFF GATE 8 | RON FIS Gate | | | B-737-900WL | MD-80 | Grp III Arr/Dep | | | | | | | | | | | | | | | | Grp III Arr/Dep | 2 | 1 | | | | |
| OFF GATE 9 | RON Offgate | | | B-737-900WL | MD-80 | Grp III Arr/Dep | | | | | | | | | | | | | | | | Grp III Arr/Dep | 2 | 1 | | | | |
| OFF GATE 10 | RON Offgate | | | B-737-900WL | MD-80 | Grp III Arr/Dep | | | | | | | | | | | | | | | | Grp III Arr/Dep | 2 | 1 | | | | |
| OFF GATE 11 | RON Offgate | | | B-737-900WL | MD-80 | Grp III Arr/Dep | | | | | | | | | | | | | | | | Grp III Arr/Dep | 2 | 1 | | | | |
| OFF GATE 12 | RON Offgate | | | B-737-900WL | MD-80 | Grp III Arr/Dep | | | | | | | | | | | | | | | | Grp III Arr/Dep | 2 | 1 | | | | |
| OFF GATE 13 | RON Offgate | | | B-737-900WL | MD-80 | Grp III Arr/Dep | | | | | | | | | | | | | | | | Grp III Arr/Dep | 2 | 1 | | | | |
| OFF GATE 14 | RON Offgate | | | B-737-900WL | MD-80 | Grp III Arr/Dep | | | | | | | | | | | | | | | | Grp III Arr/Dep | 2 | 1 | | | | |
| OFF GATE 15 | RON Offgate | | | B-737-900WL | MD-80 | Grp III Arr/Dep | | | | | | | | | | | | | | | | Grp III Arr/Dep | 2 | 1 | | | | |
| OFF GATE 16 | RON Offgate | | | B-737-900WL | MD-80 | Grp III Arr/Dep | | | | | | | | | | | | | | | | Grp III Arr/Dep | 2 | 1 | | | | |
| OFF GATE 17 | RON Offgate | | | B-737-900WL | MD-80 | Grp III Arr/Dep | Grp III Arr/Dep | | | | | | | | | | | | | | | Grp III Arr/Dep | 3 | 1.5 | | | | |
| OFF GATE 18 | RON Offgate | | | B-737-900WL | MD-80 | Grp III Arr/Dep | | | | | | | | | | | | | | | | Grp III Arr/Dep | 2 | 1 | | | | |
| OFF GATE 19 | RON Offgate | | | B-737-900WL | MD-80 | Grp III Arr/Dep | | | | | | | | | | | | | | | | Grp III Arr/Dep | 2 | 1 | | | | |
| OFF GATE 20 | RON Offgate | | | B-737-900WL | MD-80 | Grp III Arr/Dep | | | | | | | | | | | | | | | | Grp III Arr/Dep | 4 | 2 | | | | |
| OFF GATE 21 | RON Offgate | | | B-737-900WL | MD-80 | Grp III Arr/Dep | | | | | | | | | | | | | | | | Grp III Arr/Dep | 2 | 1 | | | | |
| OFF GATE 22 | RON Offgate | | | B-737-900WL | MD-80 | III Arr/Dep | | | | | | | | | | | | | | | | Grp III Arr/Dep | 4 | 2 | | | | |
| OFF GATE 23 | RON Offgate | | | B-737-900WL | MD-80 | Grp III Arr/Dep | | | | | | | | | | | | | | | | Grp III Arr/Dep | 4 | 2 | | | | |
| OFF GATE 24 | RON Offgate | | | B-737-900WL | MD-80 | Grp III Arr/Dep | | | | | | | | | | | | | | | | Grp III Arr/Dep | 2 | 1 | | | | |
| OFF GATE 25 | RON Offgate | | | B-737-900WL | MD-80 | Grp III Arr/Dep | | | | | | | | | | | | | | | | Grp III Arr/Dep | 2 | 1 | | | | |

2019 Ramp Chart

| Position | Based on 'Mix B' assuming the largest aircraft size mix | Jet Type | Jet Type Count | Max Wingspan Acft | Max Length Acft | < Start of Analysis Day > | | | | | | | | | | | | | | | | | | < End of Analysis Day > | | | | | Arr + Dep | Turns | | | | | | |
|-------------|---|----------|----------------|-------------------|-----------------|---------------------------|------|------|------|------|------|------|------|------|------|-------|-------|-------|------|------|------|------|------|-------------------------|------|------|------|-------|-----------|-------|-------|--|---|-----|-----|-----|
| | | | | | | 12 AM | 1 AM | 2 AM | 3 AM | 4 AM | 5 AM | 6 AM | 7 AM | 8 AM | 9 AM | 10 AM | 11 AM | 12 PM | 1 PM | 2 PM | 3 PM | 4 PM | 5 PM | 6 PM | 7 PM | 8 PM | 9 PM | 10 PM | | | 11 PM | | | | | |
| OFF GATE 26 | RON FIS Gate | | | B-737-900WL | MD-80 | Grp III Arr/Dep | | | | | | | | | | | | | | | | | | | | | | | | | | | 2 | 1 | | |
| OFF GATE 27 | RON FIS Gate | | | B-737-900WL | MD-80 | Grp III Arr/Dep | | | | | | | | | | | | | | | | | | | | | | | | | | | | | 2 | 1 |
| OFF GATE 28 | RON Offgate | | | B-737-900WL | MD-80 | Grp III Arr/Dep | | | | | | | | | | | | | | | | | | | | | | | | | | | | | 2 | 1 |
| OFF GATE 29 | RON FIS Gate | | | B-737-900WL | MD-80 | Grp III Arr/Dep | | | | | | | | | | | | | | | | | | | | | | | | | | | | | 2 | 1 |
| OFF GATE 30 | RON FIS Gate | | | B-737-900WL | MD-80 | Grp III Arr/Dep | | | | | | | | | | | | | | | | | | | | | | | | | | | | | 2 | 1 |
| OFF GATE 31 | RON Offgate | | | B-737-900WL | MD-80 | Grp III Arr/Dep | | | | | | | | | | | | | | | | | | | | | | | | | | | | | 3 | 1.5 |
| OFF GATE 32 | RON FIS Gate | | | B-737-900WL | MD-80 | Grp III Arr/Dep | | | | | | | | | | | | | | | | | | | | | | | | | | | | | 3 | 1.5 |
| OFF GATE 33 | RON FIS Gate | | | B-737-900WL | MD-80 | Grp III Arr/Dep | | | | | | | | | | | | | | | | | | | | | | | | | | | | | 2 | 1 |
| OFF GATE 34 | RON FIS Gate | | | B-737-900WL | MD-80 | Grp III Arr/Dep | | | | | | | | | | | | | | | | | | | | | | | | | | | | | 2 | 1 |
| OFF GATE 35 | RON FIS Gate | | | B-737-900WL | MD-80 | Grp III Arr/Dep | | | | | | | | | | | | | | | | | | | | | | | | | | | | | 2 | 1 |
| OFF GATE 36 | RON Offgate | | | E-190 | CRJ-900 | Grp III Arr/Dep | | | | | | | | | | | | | | | | | | | | | | | | | | | | 5 | 2.5 | |
| OFF GATE 37 | RON Offgate | | | E-190 | CRJ-900 | Grp II Arr/Dep | | | | | | | | | | | | | | | | | | | | | | | | | | | | | 2 | 1 |
| OFF GATE 38 | RON Offgate | | | E-190 | CRJ-900 | Grp III Arr/Dep | | | | | | | | | | | | | | | | | | | | | | | | | | | | | 3 | 1.5 |
| OFF GATE 39 | RON Offgate | | | E-190 | CRJ-900 | Grp III Arr/Dep | | | | | | | | | | | | | | | | | | | | | | | | | | | | | 1 | 0.5 |
| OFF GATE 40 | RON Offgate | | | E-190 | CRJ-900 | Grp III Arr/Dep | | | | | | | | | | | | | | | | | | | | | | | | | | | | | 1 | 0.5 |
| OFF GATE 41 | RON Offgate | | | E-190 | CRJ-900 | Grp III Arr/Dep | | | | | | | | | | | | | | | | | | | | | | | | | | | | | 2 | 1 |
| OFF GATE 42 | RON Offgate | | | B-777-300ER | | Grp IV Arr/Dep | | | | | | | | | | | | | | | | | | | | | | | | | | | | 2 | 1 | |
| OFF GATE 43 | RON Offgate | | | B-777-300ER | | | | | | | | | | | | | | | | | | | | | | | | | | 5 | 2.5 | | | | | |
| OFF GATE 44 | RON FIS Gate | | | B-767-300ERWL | | Grp III Arr/Dep | | | | | | | | | | | | | | | | | | | | | | | | | | | 5 | 2.5 | | |
| OFF GATE 45 | RON Offgate | | | B-767-300ERWL | | Grp IV Arr/Dep | | | | | | | | | | | | | | | | | | | | | | | | | | | | 4 | 2 | |
| OFF GATE 46 | RON Offgate | | | B-767-300ERWL | | Grp IV Arr/Dep | | | | | | | | | | | | | | | | | | | | | | | | | | | | 4 | 2 | |

2024 Ramp Chart

| Position | Based on 'Mix B' assuming the largest aircraft size mix | Jet Type | Jet Type Count | Max Wingspan Acrft | Max Length Acrft | Depend Group |
|----------|---|----------|----------------|--------------------|------------------|--------------|
| INT 1 | Existing | V | 1 | B-777-300ER | | |
| INT 2 | Existing | V | 2 | B-777-300ER | | |
| INT 3 | Existing | V | 3 | B-777-300ER | | |
| INT 4 | Existing | V | 4 | B-777-300ER | | |
| INT 5 | Existing | V | 5 | B-777-300ER | | |
| INT 6 | Existing | V | 6 | B-777-300ER | | |
| INT 7 | Existing | V | 7 | B-777-300ER | | |
| INT 8 | Existing | V | 8 | B-777-300ER | | |
| INT 9 | Existing | V | 9 | B-777-300ER | | |
| INT 10 | Existing | V | 10 | B-777-300ER | | |
| INT 11 | New | | | B-777-300ER | | |
| INT 12 | New | | | B-777-300ER | | |
| INT 13 | New | | | B-777-300ER | | |
| INT 14 | New | | | B-777-300ER | | |
| INT 15 | New | | | B-777-300ER | | |
| INT 16 | New | | | B-777-300ER | | |
| INT 17 | New | | | B-777-300ER | | |
| INT 18 | New | | | B-777-300ER | | |
| INT 19 | New | | | B-777-300ER | | |
| INT 20 | Existing | IV | 1 | B-767-300ERWL | | |
| INT 21 | Existing | IV | 2 | B-767-300ERWL | | |
| INT 22 | New | | | B-737-900WL | MD-80 | |

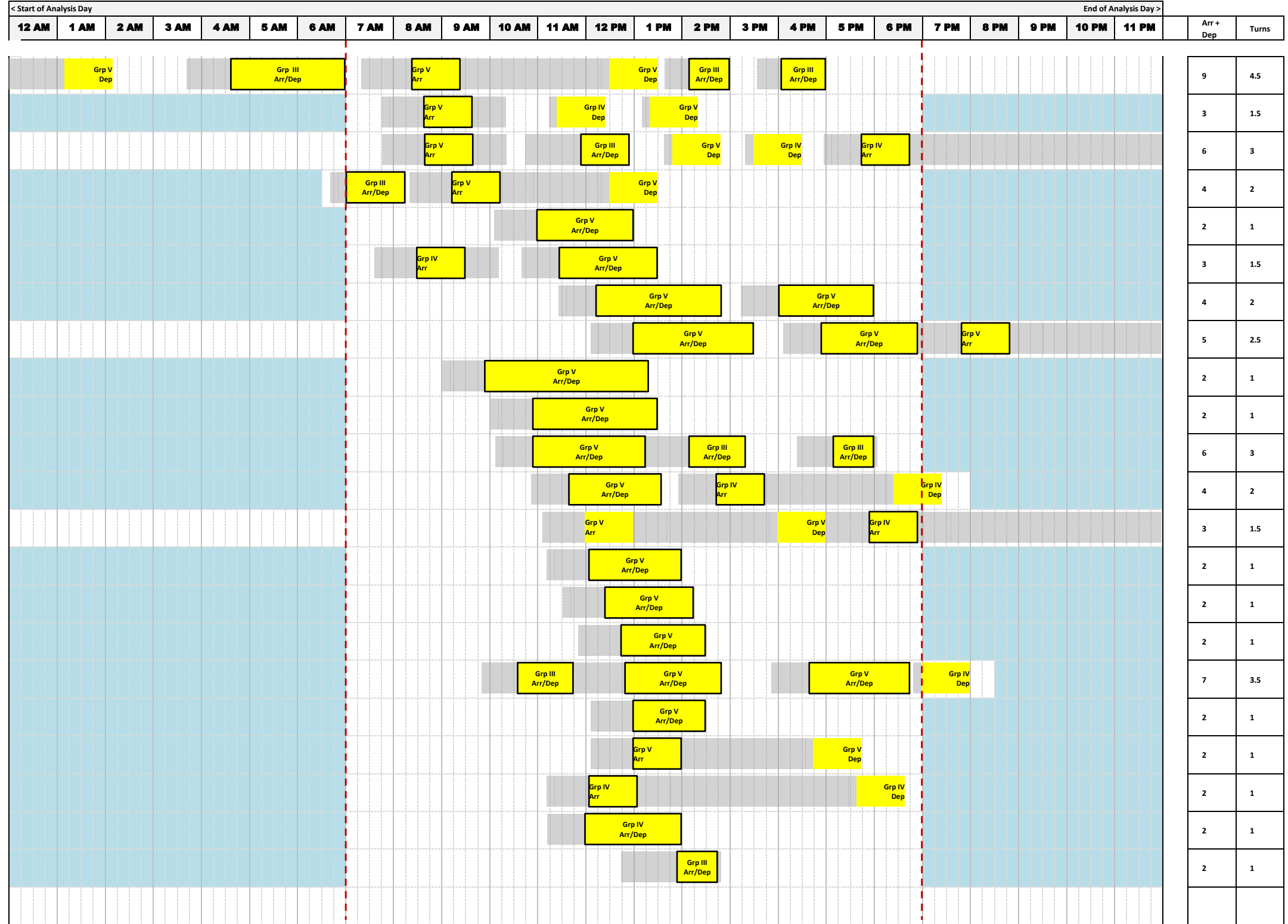

2024 Ramp Chart

| Position | Based on 'Mix B' assuming the largest aircraft size mix | Jet Type | Jet Type Count | Max Wingspan Acrft | Max Length Acrft | Depend Group |
|----------|---|----------|----------------|--------------------|------------------|--------------|
| DOM 1 | Existing | IV | 1 | B-767-300ERWL | | |
| DOM 2 | Existing | IV | 2 | B-767-300ERWL | | |
| DOM 3 | Existing | IV | 3 | B-767-300ERWL | | |
| DOM 4 | Existing | IV | 4 | B-767-300ERWL | | |
| DOM 5 | Existing | IV | 5 | B-767-300ERWL | | |
| DOM 6 | Existing | IV | 6 | B-767-300ERWL | | |
| DOM 7 | Existing | III | 1 | B-737-900WL | MD-80 | |
| DOM 8 | Existing | III | 2 | B-737-900WL | MD-80 | |
| DOM 9 | Existing | III | 3 | B-737-900WL | MD-80 | |
| DOM 10 | Existing | III | 4 | B-737-900WL | MD-80 | |
| DOM 11 | Existing | III | 5 | B-737-900WL | MD-80 | |
| DOM 12 | Existing | III | 6 | B-737-900WL | MD-80 | |
| DOM 13 | Existing | III | 7 | B-737-900WL | MD-80 | |
| DOM 14 | Existing | III | 8 | B-737-900WL | MD-80 | |
| DOM 15 | Existing | III | 9 | B-737-900WL | MD-80 | |
| DOM 16 | Existing | RJ | 1 | E-190 | CRJ-900 | |
| DOM 17 | Existing | RJ | 2 | E-190 | CRJ-900 | |
| DOM 18 | Existing | RJ | 3 | E-190 | CRJ-900 | |
| DOM 19 | Existing | RJ | 4 | E-190 | CRJ-900 | |
| DOM 20 | Existing | RJ | 5 | E-190 | CRJ-900 | |
| DOM 21 | Existing | RJ | 6 | E-190 | CRJ-900 | |
| DOM 22 | Existing | RJ | 7 | E-190 | CRJ-900 | |
| DOM 23 | Existing | RJ | 8 | E-190 | CRJ-900 | |

| < Start of Analysis Day > | | | | | | | | | | | | | | | | | | | | | | > End of Analysis Day > | | | |
|---------------------------|------------|-------------|------|-------------|-------------|----------------|-----------------|-----------------|-----------------|-----------------|-----------------|-----------------|-----------------|-----------------|-----------------|-----------------|-----------------|-----------------|-----------------|-----------------|-----------------|-------------------------|-----------------|-----------|-------|
| 12 AM | 1 AM | 2 AM | 3 AM | 4 AM | 5 AM | 6 AM | 7 AM | 8 AM | 9 AM | 10 AM | 11 AM | 12 PM | 1 PM | 2 PM | 3 PM | 4 PM | 5 PM | 6 PM | 7 PM | 8 PM | 9 PM | 10 PM | 11 PM | Arr + Dep | Turns |
| | | | | | | Grp III Dep | Grp III Dep | Grp III Arr/Dep | Grp IV Dep | Grp III Arr/Dep | Grp III Arr/Dep | Grp III Arr/Dep | Grp III Arr/Dep | Grp III Arr/Dep | Grp III Arr/Dep | Grp III Arr/Dep | Grp III Arr/Dep | Grp III Arr/Dep | Grp III Arr/Dep | Grp III Arr/Dep | Grp III Arr/Dep | Grp III Arr/Dep | Grp III Arr/Dep | 20 | 10 |
| | | | | | | | | Grp IV Dep | Grp III Arr/Dep | Grp IV Arr/Dep | Grp IV Arr/Dep | | Grp IV Arr/Dep | Grp IV Arr/Dep | Grp III Arr/Dep | Grp III Arr/Dep | Grp III Arr/Dep | Grp III Arr/Dep | Grp III Arr/Dep | Grp III Arr/Dep | Grp III Arr/Dep | Grp III Arr/Dep | Grp III Arr/Dep | 21 | 10.5 |
| | Grp IV Dep | Grp IV Arr | | | | Grp IV Dep | Grp III Dep | | Grp IV Arr/Dep | Grp IV Arr/Dep | Grp III Arr/Dep | | Grp IV Arr/Dep | Grp IV Arr/Dep | Grp III Arr/Dep | Grp III Arr/Dep | Grp III Arr/Dep | Grp III Arr/Dep | Grp III Arr/Dep | Grp III Arr/Dep | Grp III Arr/Dep | Grp III Arr/Dep | Grp III Arr/Dep | 20 | 10 |
| | | Grp III Dep | | Grp III Arr | | Grp IV Arr/Dep | Grp III Arr/Dep | Grp IV Arr/Dep | Grp III Arr/Dep | Grp IV Arr/Dep | Grp III Arr/Dep | Grp IV Arr/Dep | Grp IV Arr/Dep | Grp IV Arr/Dep | Grp III Arr/Dep | Grp III Arr/Dep | Grp III Arr/Dep | Grp III Arr/Dep | Grp III Arr/Dep | Grp III Arr/Dep | Grp III Arr/Dep | Grp III Arr/Dep | Grp III Arr/Dep | 25 | 12.5 |
| | | | | | Grp III Arr | Grp IV Arr | Grp III Dep | Grp IV Dep | Grp IV Arr/Dep | Grp III Arr/Dep | | Grp III Arr/Dep | Grp III Arr/Dep | Grp III Arr/Dep | Grp III Arr/Dep | Grp III Arr/Dep | Grp III Arr/Dep | Grp III Arr/Dep | Grp III Arr/Dep | Grp III Arr/Dep | Grp III Arr/Dep | Grp III Arr/Dep | Grp III Arr/Dep | 22 | 11 |
| | | | | | | Grp IV Arr/Dep | Grp IV Arr/Dep | Grp IV Arr/Dep | Grp IV Arr/Dep | Grp IV Arr/Dep | Grp IV Arr/Dep | Grp IV Arr/Dep | Grp IV Arr/Dep | Grp IV Arr/Dep | Grp III Arr/Dep | Grp III Arr/Dep | Grp III Arr/Dep | Grp III Arr/Dep | Grp III Arr/Dep | Grp III Arr/Dep | Grp III Arr/Dep | Grp III Arr/Dep | Grp IV Arr/Dep | 22 | 11 |
| | | | | | | | | Grp III Dep | Grp III Arr/Dep | Grp III Arr/Dep | Grp III Arr/Dep | Grp III Arr/Dep | Grp III Arr/Dep | Grp III Arr/Dep | Grp III Arr/Dep | Grp III Arr/Dep | Grp III Arr/Dep | Grp III Arr/Dep | Grp III Arr/Dep | Grp III Arr/Dep | Grp III Arr/Dep | Grp III Arr/Dep | Grp III Arr/Dep | 14 | 7 |
| | | | | | | | Grp III Dep | | Grp II Arr/Dep | Grp III Arr/Dep | | Grp III Arr/Dep | Grp III Arr/Dep | Grp III Arr/Dep | Grp III Arr/Dep | Grp III Arr/Dep | Grp III Arr/Dep | Grp III Arr/Dep | Grp III Arr/Dep | Grp III Arr/Dep | Grp III Arr/Dep | Grp III Arr/Dep | Grp III Arr/Dep | 17 | 8.5 |
| | | | | | | | | | Grp III Dep | Grp III Arr/Dep | Grp III Arr/Dep | Grp III Arr/Dep | Grp III Arr/Dep | Grp III Arr/Dep | Grp III Arr/Dep | Grp III Arr/Dep | Grp III Arr/Dep | Grp III Arr/Dep | Grp III Arr/Dep | Grp III Arr/Dep | Grp III Arr/Dep | Grp III Arr/Dep | Grp III Arr/Dep | 12 | 6 |
| | | | | | | | | | Grp III Dep | Grp III Arr/Dep | Grp III Arr/Dep | Grp III Arr/Dep | Grp III Arr/Dep | Grp III Arr/Dep | Grp III Arr/Dep | Grp III Arr/Dep | Grp III Arr/Dep | Grp III Arr/Dep | Grp III Arr/Dep | Grp III Arr/Dep | Grp III Arr/Dep | Grp III Arr/Dep | Grp III Arr/Dep | 17 | 8.5 |
| | | | | | | | | | Grp III Dep | Grp III Arr/Dep | Grp III Arr/Dep | Grp III Arr/Dep | Grp III Arr/Dep | Grp III Arr/Dep | Grp III Arr/Dep | Grp III Arr/Dep | Grp III Arr/Dep | Grp III Arr/Dep | Grp III Arr/Dep | Grp III Arr/Dep | Grp III Arr/Dep | Grp III Arr/Dep | Grp III Arr/Dep | 21 | 10.5 |
| | | | | | | | | | Grp III Dep | Grp III Arr/Dep | Grp III Arr/Dep | Grp III Arr/Dep | Grp III Arr/Dep | Grp III Arr/Dep | Grp III Arr/Dep | Grp III Arr/Dep | Grp III Arr/Dep | Grp III Arr/Dep | Grp III Arr/Dep | Grp III Arr/Dep | Grp III Arr/Dep | Grp III Arr/Dep | Grp III Arr/Dep | 16 | 8 |
| | | | | | | | Grp III Arr/Dep | | Grp III Arr/Dep | Grp III Arr/Dep | Grp III Arr/Dep | Grp III Arr/Dep | Grp III Arr/Dep | Grp III Arr/Dep | Grp III Arr/Dep | Grp III Arr/Dep | Grp III Arr/Dep | Grp III Arr/Dep | Grp III Arr/Dep | Grp III Arr/Dep | Grp III Arr/Dep | Grp III Arr/Dep | Grp III Arr/Dep | 18 | 9 |
| | | | | | | | | Grp III Arr/Dep | Grp III Arr/Dep | Grp III Arr/Dep | Grp III Arr/Dep | Grp III Arr/Dep | Grp III Arr/Dep | Grp III Arr/Dep | Grp III Arr/Dep | Grp III Arr/Dep | Grp III Arr/Dep | Grp III Arr/Dep | Grp III Arr/Dep | Grp III Arr/Dep | Grp III Arr/Dep | Grp III Arr/Dep | Grp III Arr/Dep | 17 | 8.5 |
| | | | | | | | | Grp III Arr/Dep | Grp III Arr | Grp III Arr/Dep | Grp III Arr/Dep | Grp III Arr/Dep | Grp III Arr/Dep | Grp III Arr/Dep | Grp III Arr/Dep | Grp III Arr/Dep | Grp III Arr/Dep | Grp III Arr/Dep | Grp III Arr/Dep | Grp III Arr/Dep | Grp III Arr/Dep | Grp III Arr/Dep | Grp III Arr/Dep | 19 | 9.5 |
| | | | | | | | | Grp III Dep | | Grp III Arr/Dep | | Grp III Arr/Dep | Grp III Arr/Dep | Grp III Arr/Dep | Grp III Arr/Dep | Grp III Arr/Dep | Grp III Arr/Dep | Grp III Arr/Dep | Grp III Arr/Dep | Grp III Arr/Dep | Grp III Arr/Dep | Grp III Arr/Dep | Grp III Arr/Dep | 9 | 4.5 |
| | | | | | | | | Grp III Dep | | Grp III Arr/Dep | | Grp III Arr/Dep | Grp III Arr/Dep | Grp III Arr/Dep | Grp III Arr/Dep | Grp III Arr/Dep | Grp III Arr/Dep | Grp III Arr/Dep | Grp III Arr/Dep | Grp III Arr/Dep | Grp III Arr/Dep | Grp III Arr/Dep | Grp III Arr/Dep | 10 | 5 |
| | | | | | | | | Grp III Dep | | Grp III Arr/Dep | | Grp III Arr/Dep | Grp III Arr/Dep | Grp III Arr/Dep | Grp III Arr/Dep | Grp III Arr/Dep | Grp III Arr/Dep | Grp III Arr/Dep | Grp III Arr/Dep | Grp III Arr/Dep | Grp III Arr/Dep | Grp III Arr/Dep | Grp III Arr/Dep | 12 | 6 |
| | | | | | | | | Grp III Dep | | Grp III Arr/Dep | | Grp III Arr/Dep | Grp III Arr/Dep | Grp III Arr/Dep | Grp III Arr/Dep | Grp III Arr/Dep | Grp III Arr/Dep | Grp III Arr/Dep | Grp III Arr/Dep | Grp III Arr/Dep | Grp III Arr/Dep | Grp III Arr/Dep | Grp III Arr/Dep | 10 | 5 |
| | | | | | | | | | Grp III Arr/Dep | | Grp II Arr/Dep | | Grp III Arr/Dep | | Grp III Arr/Dep | | Grp III Arr/Dep | Grp III Arr | Grp III Arr | | | Grp III Arr/Dep | Grp III Arr/Dep | 8 | 4 |
| | | | | | | | | | Grp III Arr/Dep | | Grp III Arr/Dep | | Grp III Arr/Dep | | Grp III Arr/Dep | | Grp III Arr/Dep | | | | | | Grp III Arr/Dep | 4 | 2 |
| | | | | | | | | | Grp III Arr/Dep | | Grp III Arr/Dep | | Grp III Arr/Dep | | Grp III Arr/Dep | | Grp III Arr/Dep | | | | | Grp III Arr/Dep | 6 | 3 | |
| | | | | | | | | | Grp II Arr/Dep | | Grp III Arr/Dep | | Grp III Arr/Dep | | Grp III Arr/Dep | | Grp III Arr/Dep | | | | | Grp III Arr/Dep | 6 | 3 | |

2024 Ramp Chart

| Position | Based on 'Mix B' assuming the largest aircraft size mix | Jet Type | Jet Type Count | Max Wingspan Acft | Max Length Acft | Depend Group |
|----------|---|----------|----------------|-------------------|-----------------|--------------|
| DOM 24 | Existing | III | 10 | B-737-900WL | MD-80 | |
| DOM 25 | Existing | III | 11 | B-737-900WL | MD-80 | |
| DOM 26 | Existing | III | 12 | B-737-900WL | MD-80 | |
| DOM 27 | Existing | III | 13 | B-737-900WL | MD-80 | |
| DOM 28 | Existing | III | 14 | B-737-900WL | MD-80 | |
| DOM 29 | Existing | III | 15 | B-737-900WL | MD-80 | |
| DOM 30 | Existing | III | 16 | B-737-900WL | MD-80 | |
| DOM 31 | Existing | III | 17 | B-737-900WL | MD-80 | |
| DOM 32 | Existing | III | 18 | B-737-900WL | MD-80 | |
| DOM 33 | Existing | III | 19 | B-737-900WL | MD-80 | |
| DOM 34 | Existing | III | 20 | B-737-900WL | MD-80 | |
| DOM 35 | Existing | III | 21 | B-737-900WL | MD-80 | |
| DOM 36 | Existing | III | 22 | B-737-900WL | MD-80 | |
| DOM 37 | Existing | III | 23 | B-737-900WL | MD-80 | |
| DOM 38 | Existing | III | 24 | B-737-900WL | MD-80 | |
| DOM 39 | Existing | III | 25 | B-737-900WL | MD-80 | |
| DOM 40 | Existing | III | 26 | B-737-900WL | MD-80 | |
| DOM 41 | Existing | III | 27 | B-737-900WL | MD-80 | |
| DOM 42 | Existing | III | 28 | B-737-900WL | MD-80 | |
| DOM 43 | Existing | III | 29 | B-737-900WL | MD-80 | |
| DOM 44 | Existing | III | 30 | B-737-900WL | MD-80 | |
| DOM 45 | Existing | III | 31 | B-737-900WL | MD-80 | |
| DOM 46 | Existing | III | 32 | B-737-900WL | MD-80 | |
| DOM 47 | Existing | III | 33 | B-737-900WL | MD-80 | |
| DOM 48 | Existing | III | 34 | B-737-900WL | MD-80 | |
| DOM 49 | Existing | III | 35 | B-737-900WL | MD-80 | |

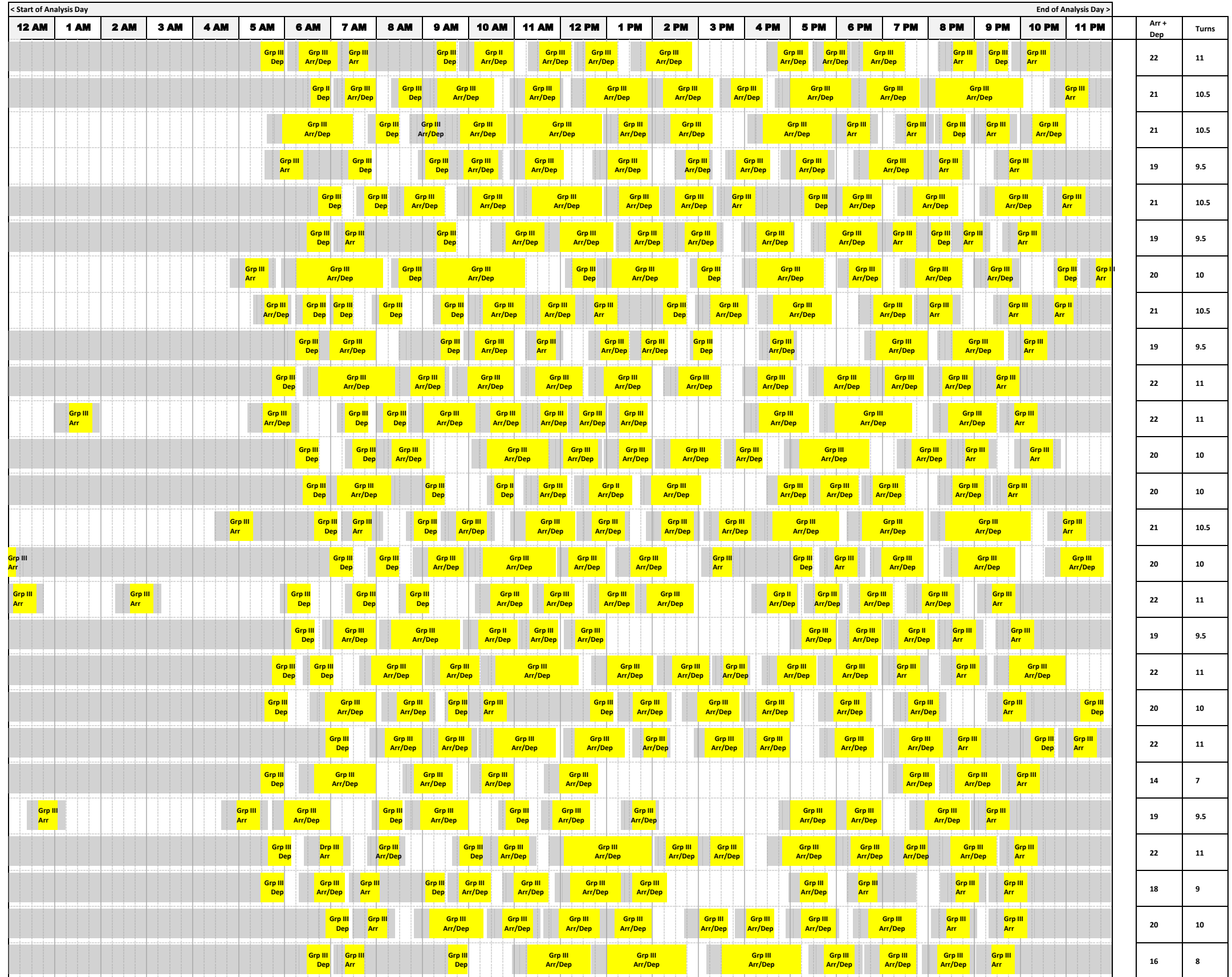

2024 Ramp Chart

| Position | Based on 'Mix B' assuming the largest aircraft size mix | Jet Type | Jet Type Count | Max Wingspan Acft | Max Length Acft | Depend Group |
|----------|---|----------|----------------|-------------------|-----------------|--------------|
| DOM 50 | Existing | RJ | 9 | E-190 | CRJ-900 | |
| DOM 51 | Existing | RJ | 10 | E-190 | CRJ-900 | |
| DOM 52 | Existing | RJ | 11 | E-190 | CRJ-900 | |
| DOM 53 | Not Needed | | | E-190 | CRJ-900 | |
| DOM 54 | Existing | RJ | 12 | E-190 | CRJ-900 | |
| DOM 55 | Existing | RJ | 13 | E-190 | CRJ-900 | |
| DOM 56 | Existing | RJ | 14 | E-190 | CRJ-900 | |
| DOM 57 | Existing | RJ | 15 | E-190 | CRJ-900 | |
| DOM 58 | Existing | RJ | 16 | E-190 | CRJ-900 | |
| DOM 59 | Existing | RJ | 17 | E-190 | CRJ-900 | |
| DOM 60 | Not Needed | | | E-190 | CRJ-900 | |
| DOM 61 | Existing | RJ | 18 | E-190 | CRJ-900 | |
| DOM 62 | Not Needed | | | E-190 | CRJ-900 | |
| DOM 63 | Existing | RJ | 19 | E-190 | CRJ-900 | |
| DOM 64 | Existing | RJ | 20 | E-190 | CRJ-900 | |
| DOM 65 | New | | | E-190 | CRJ-900 | |

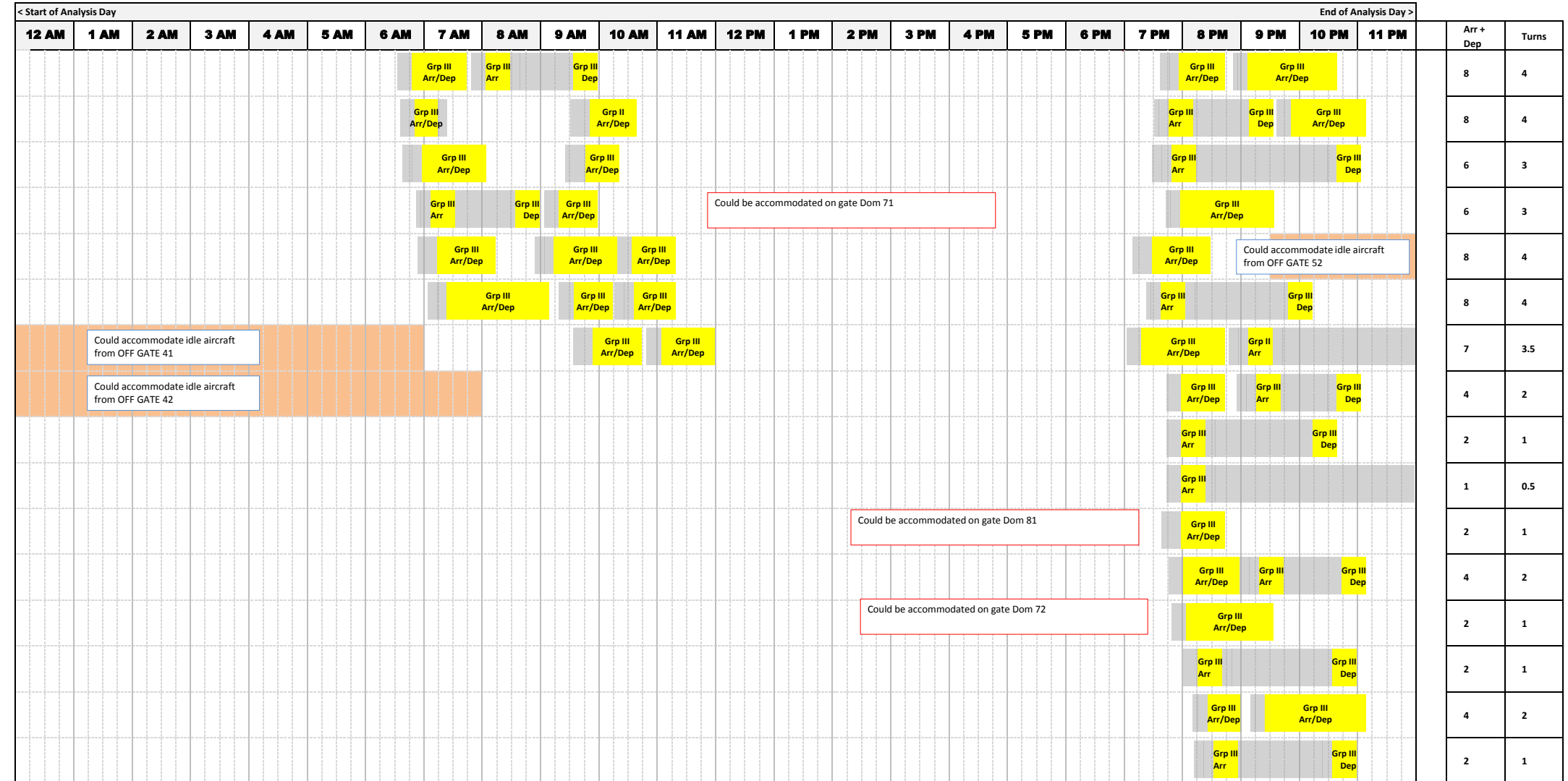

| Arr + Dep | Turns |
|-----------|-------|
| 8 | 4 |
| 8 | 4 |
| 6 | 3 |
| 6 | 3 |
| 8 | 4 |
| 8 | 4 |
| 7 | 3.5 |
| 4 | 2 |
| 2 | 1 |
| 1 | 0.5 |
| 2 | 1 |
| 4 | 2 |
| 2 | 1 |
| 2 | 1 |
| 4 | 2 |
| 2 | 1 |

2024 Ramp Chart

| Position | Based on 'Mix B' assuming the largest aircraft size mix | Jet Type | Jet Type Count | Max Wingspan Acft | Max Length Acft | Depend Group |
|----------|---|----------|----------------|-------------------|-----------------|--------------|
| DOM 66 | Existing | V | 1 | B-777-300ER | | |
| DOM 67 | Existing | IV | 7 | B-767-300ERWL | | |
| DOM 68 | Existing | IV | 8 | B-767-300ERWL | | |
| DOM 69 | Existing | IV | 9 | B-767-300ERWL | | |
| DOM 70 | Existing | IV | 10 | B-767-300ERWL | | |
| DOM 71 | Existing | III | 36 | B-737-900WL | MD-80 | |
| DOM 72 | Existing | III | 37 | B-737-900WL | MD-80 | |
| DOM 73 | Existing | III | 38 | B-737-900WL | MD-80 | |
| DOM 74 | Existing | III | 39 | B-737-900WL | MD-80 | |
| DOM 75 | New | | | B-737-900WL | MD-80 | |
| DOM 76 | New | | | B-737-900WL | MD-80 | |
| DOM 77 | New | | | B-737-900WL | MD-80 | |
| DOM 78 | New | | | B-737-900WL | MD-80 | |
| DOM 79 | New | | | B-737-900WL | MD-80 | |
| DOM 80 | New | | | B-737-900WL | MD-80 | |
| DOM 81 | New | | | B-737-900WL | MD-80 | |
| DOM 82 | New | | | B-737-900WL | MD-80 | |
| DOM 83 | New | | | B-737-900WL | MD-80 | |
| DOM 84 | New | | | B-737-900WL | MD-80 | |
| DOM 85 | New | | | B-737-900WL | MD-80 | |

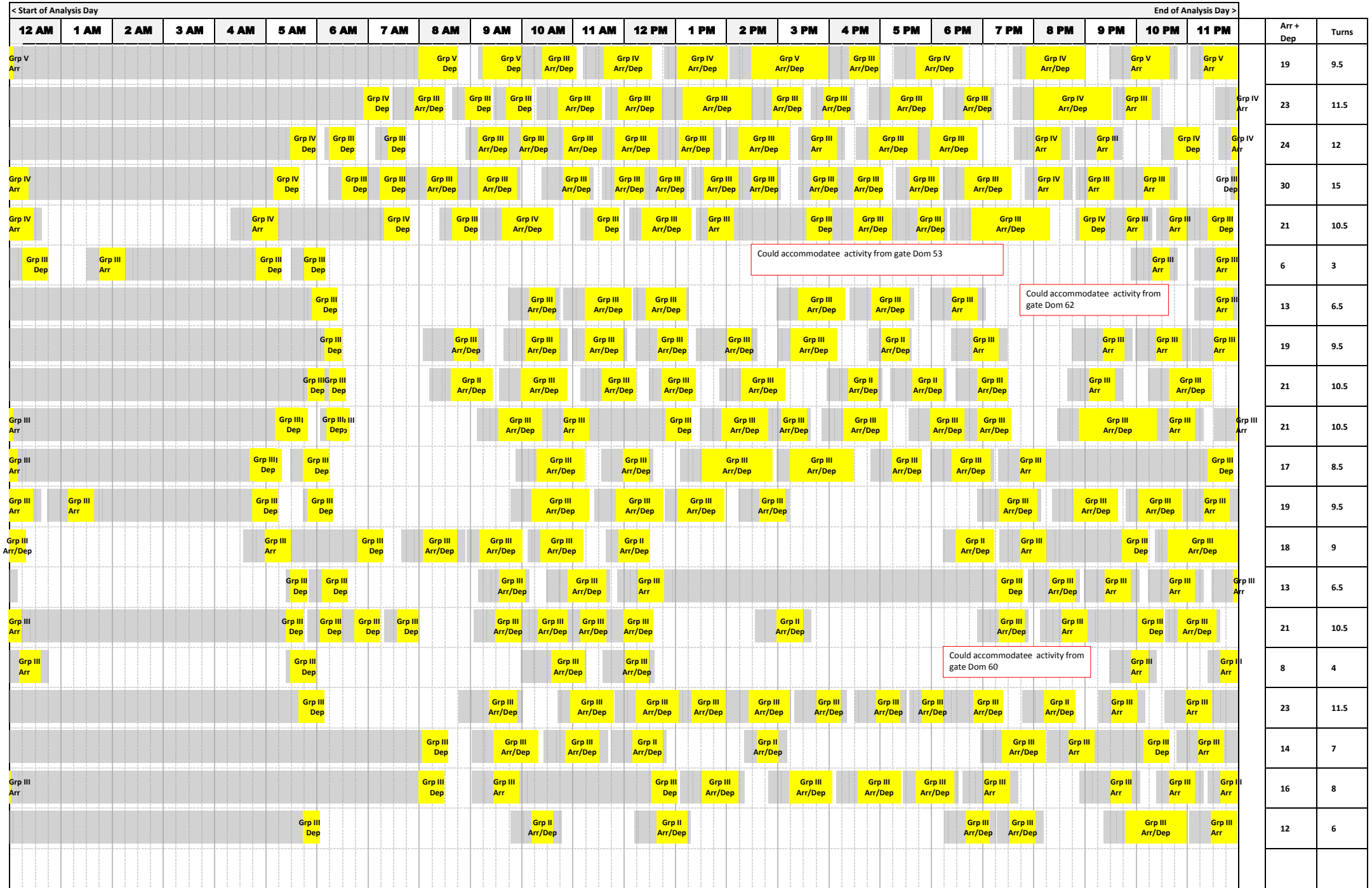

2024 Ramp Chart

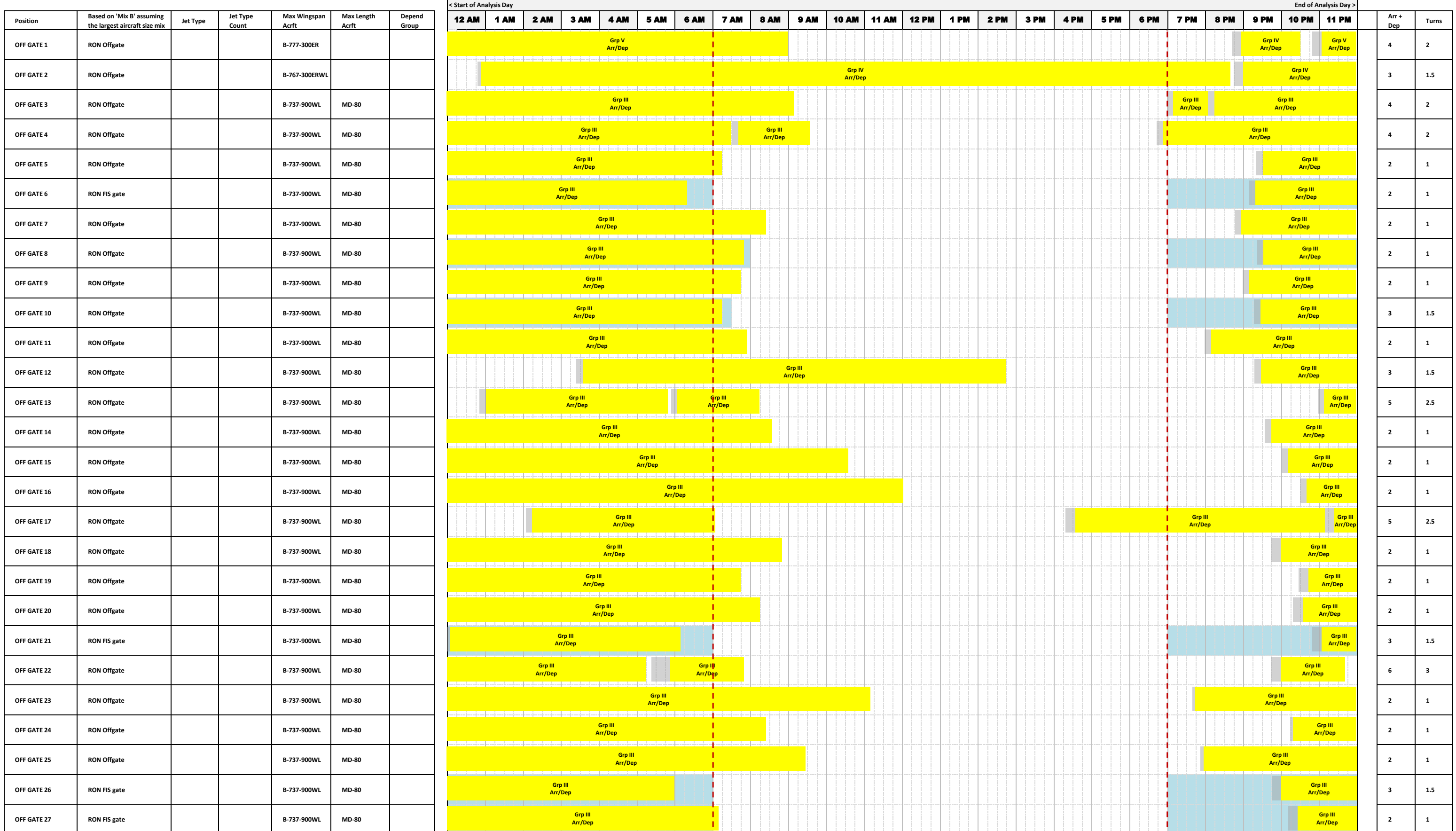

2024 Ramp Chart

| Position | Based on 'Mix B' assuming the largest aircraft size mix | Jet Type | Jet Type Count | Max Wingspan Acft | Max Length Acft | Depend Group |
|-------------|---|----------|----------------|-------------------|-----------------|--------------|
| OFF GATE 28 | RON Offgate | | | B-737-900WL | MD-80 | |
| OFF GATE 29 | RON FIS gate | | | B-737-900WL | MD-80 | |
| OFF GATE 30 | RON FIS gate | | | B-737-900WL | MD-80 | |
| OFF GATE 31 | RON FIS gate | | | B-737-900WL | MD-80 | |
| OFF GATE 32 | RON FIS gate | | | B-737-900WL | MD-80 | |
| OFF GATE 33 | RON FIS gate | | | B-737-900WL | MD-80 | |
| OFF GATE 34 | RON FIS gate | | | B-737-900WL | MD-80 | |
| OFF GATE 35 | RON FIS gate | | | B-737-900WL | MD-80 | |
| OFF GATE 36 | RON FIS gate | | | B-737-900WL | MD-80 | |
| OFF GATE 37 | RON FIS gate | | | B-737-900WL | MD-80 | |
| OFF GATE 38 | RON Offgate | | | E-190 | CRJ-900 | |
| OFF GATE 39 | RON Offgate | | | E-190 | CRJ-900 | |
| OFF GATE 40 | RON FIS gate | | | E-190 | CRJ-900 | |
| OFF GATE 41 | RON FIS gate | | | E-190 | CRJ-900 | |
| OFF GATE 42 | RON Offgate | | | E-190 | CRJ-900 | |
| OFF GATE 43 | RON Offgate | | | E-190 | CRJ-900 | |
| OFF GATE 44 | RON Offgate | | | B-777-300ER | | |
| OFF GATE 45 | RON Offgate | | | B-777-300ER | | |
| OFF GATE 46 | RON Offgate | | | B-767-300ERWL | | |
| OFF GATE 47 | RON Offgate | | | B-767-300ERWL | | |
| OFF GATE 48 | RON Offgate | | | B-767-300ERWL | | |
| OFF GATE 49 | RON Offgate | | | B-737-900WL | MD-80 | |
| OFF GATE 50 | RON Offgate | | | B-737-900WL | MD-80 | |
| OFF GATE 51 | RON Offgate | | | B-737-900WL | MD-80 | |
| OFF GATE 52 | RON Offgate | | | E-190 | CRJ-900 | |

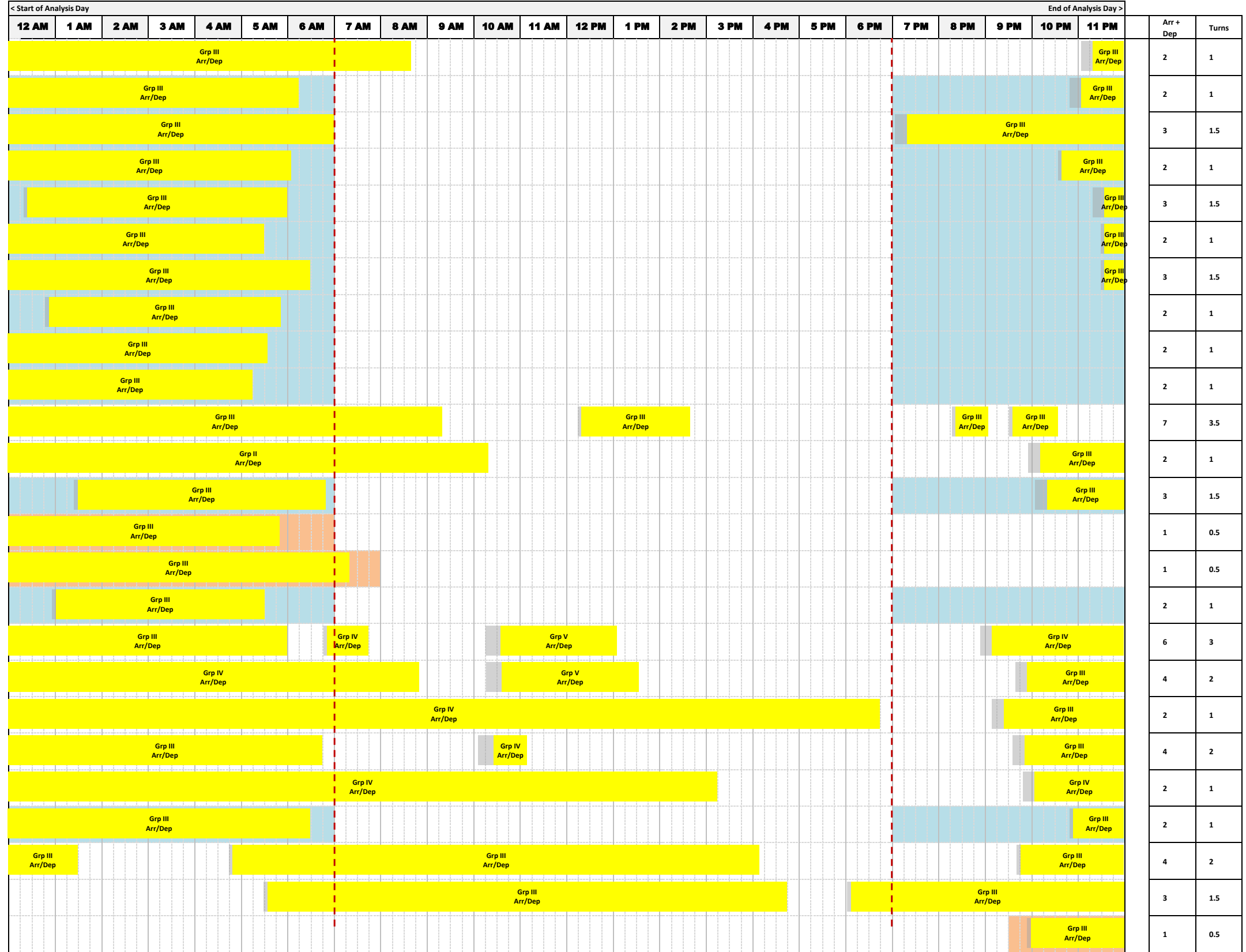

2029 Ramp Chart

| Position | Based on 'Mix B' assuming the largest aircraft size mix | Jet Type | Jet Type Count | Max Wingspan Acft | Max Length Acft | Depend Group |
|----------|---|----------|----------------|-------------------|-----------------|--------------|
| INT 1 | Existing | V | 1 | B-777-300ER | | |
| INT 2 | Existing | V | 2 | B-777-300ER | | |
| INT 3 | Existing | V | 3 | B-777-300ER | | |
| INT 4 | Existing | V | 4 | B-777-300ER | | |
| INT 5 | Existing | V | 5 | B-777-300ER | | |
| INT 6 | Existing | V | 6 | B-777-300ER | | |
| INT 7 | Existing | V | 7 | B-777-300ER | | |
| INT 8 | Existing | V | 8 | B-777-300ER | | |
| INT 9 | Existing | V | 9 | B-777-300ER | | |
| INT 10 | Existing | V | 10 | B-777-300ER | | |
| INT 11 | New | | | B-777-300ER | | |
| INT 12 | New | | | B-777-300ER | | |
| INT 13 | New | | | B-777-300ER | | |
| INT 14 | New | | | B-777-300ER | | |
| INT 15 | New | | | B-777-300ER | | |
| INT 16 | New | | | B-777-300ER | | |
| INT 17 | New | | | B-777-300ER | | |
| INT 18 | New | | | B-777-300ER | | |
| INT 19 | New | | | B-777-300ER | | |
| INT 20 | New | | | B-777-300ER | | |
| INT 21 | New | | | B-777-300ER | | |
| INT 22 | New | | | B-777-300ER | | |
| INT 23 | Existing | IV | 1 | B-767-300ERWL | | |
| INT 24 | Existing | IV | 2 | B-737-900WL | MD-80 | |

| | | | | | | |
|-------|----------|----|---|---------------|--|--|
| DOM 1 | Existing | V | 1 | B-777-300ER | | |
| DOM 2 | Existing | IV | 1 | B-767-300ERWL | | |

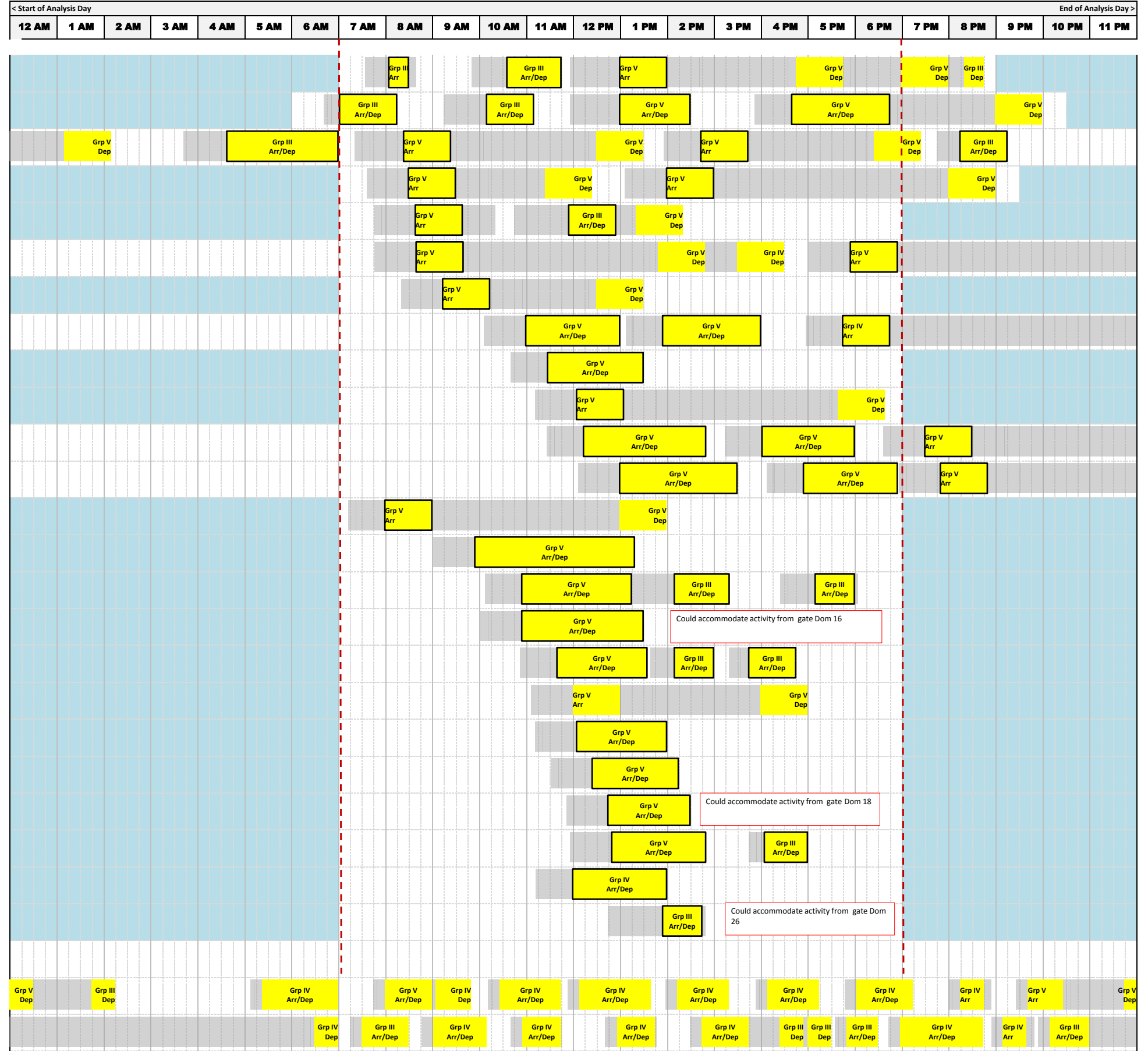

| Arr + Dep | Turns |
|-----------|-------|
| 7 | 3.5 |
| 9 | 4.5 |
| 9 | 4.5 |
| 4 | 2 |
| 4 | 2 |
| 4 | 2 |
| 2 | 1 |
| 5 | 2.5 |
| 2 | 1 |
| 2 | 1 |
| 5 | 2.5 |
| 5 | 2.5 |
| 2 | 1 |
| 2 | 1 |
| 6 | 3 |
| 2 | 1 |
| 6 | 3 |
| 2 | 1 |
| 2 | 1 |
| 2 | 1 |
| 4 | 2 |
| 2 | 1 |
| 2 | 1 |
| 20 | 10 |
| 20 | 10 |

2029 Ramp Chart

| Position | Based on 'Mix B' assuming the largest aircraft size mix | Jet Type | Jet Type Count | Max Wingspan Acft | Max Length Acft | Depend Group |
|----------|---|----------|----------------|-------------------|-----------------|--------------|
| DOM 3 | Existing | IV | 2 | B-767-300ERWL | | |
| DOM 4 | Existing | IV | 3 | B-767-300ERWL | | |
| DOM 5 | Existing | IV | 4 | B-767-300ERWL | | |
| DOM 6 | Existing | IV | 5 | B-767-300ERWL | | |
| DOM 7 | Existing | III | 1 | B-737-900WL | MD-80 | |
| DOM 8 | Existing | III | 2 | B-737-900WL | MD-80 | |
| DOM 9 | Existing | III | 3 | B-737-900WL | MD-80 | |

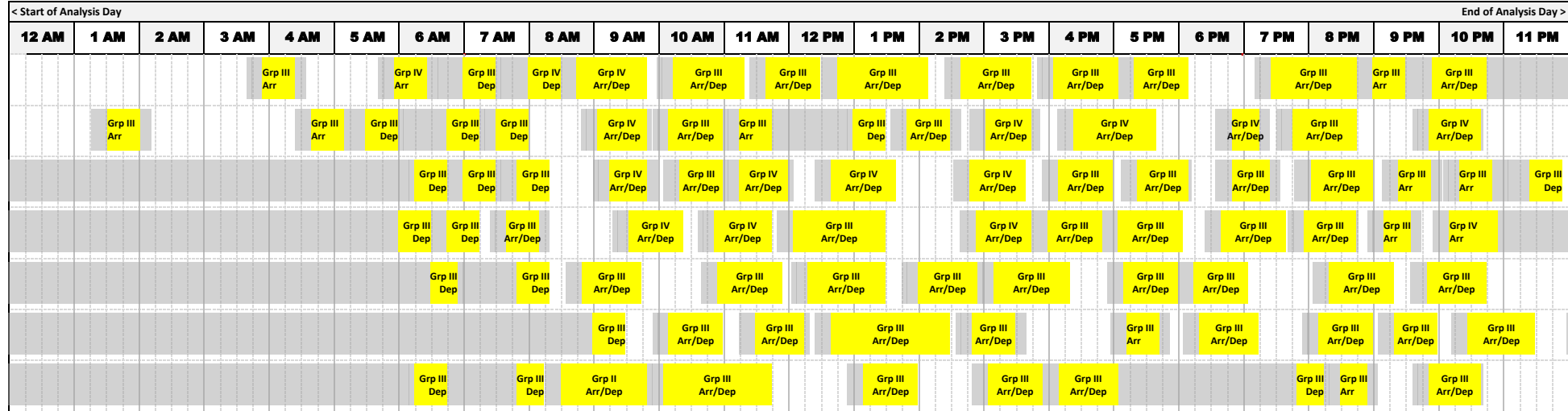

| Arr + Dep | Turns |
|-----------|-------|
| 23 | 11.5 |
| 23 | 11.5 |
| 24 | 12 |
| 22 | 11 |
| 20 | 10 |
| 18 | 9 |
| 16 | 8 |

2029 Ramp Chart

| Position | Based on 'Mix B' assuming the largest aircraft size mix | Jet Type | Jet Type Count | Max Wingspan Acft | Max Length Acft | Depend Group |
|----------|---|----------|----------------|-------------------|-----------------|--------------|
| DOM 10 | Existing | III | 4 | B-737-900WL | MD-80 | |
| DOM 11 | Existing | III | 5 | B-737-900WL | MD-80 | |
| DOM 12 | Existing | III | 6 | B-737-900WL | MD-80 | |
| DOM 13 | Existing | III | 7 | B-737-900WL | MD-80 | |
| DOM 14 | Existing | III | 8 | B-737-900WL | MD-80 | |
| DOM 15 | Existing | III | 9 | B-737-900WL | MD-80 | |
| DOM 16 | Not Needed | | | B-737-900WL | MD-80 | |
| DOM 17 | Existing | RJ | 1 | E-190 | CRJ-900 | |
| DOM 18 | Not Needed | | | E-190 | CRJ-900 | |
| DOM 19 | Existing | RJ | 2 | E-190 | CRJ-900 | |
| DOM 20 | Existing | RJ | 3 | E-190 | CRJ-900 | |
| DOM 21 | Existing | RJ | 4 | E-190 | CRJ-900 | |
| DOM 22 | Existing | RJ | 5 | E-190 | CRJ-900 | |
| DOM 23 | Existing | RJ | 6 | E-190 | CRJ-900 | |
| DOM 24 | Existing | RJ | 7 | E-190 | CRJ-900 | |
| DOM 25 | Existing | RJ | 8 | E-190 | CRJ-900 | |
| DOM 26 | Not Needed | | | E-190 | CRJ-900 | |
| DOM 27 | Existing | III | 10 | B-737-900WL | MD-80 | |
| DOM 28 | Existing | III | 11 | B-737-900WL | MD-80 | |
| DOM 29 | Existing | III | 12 | B-737-900WL | MD-80 | |
| DOM 30 | Existing | III | 13 | B-737-900WL | MD-80 | |
| DOM 31 | Existing | III | 14 | B-737-900WL | MD-80 | |
| DOM 32 | Existing | III | 15 | B-737-900WL | MD-80 | |
| DOM 33 | Existing | III | 16 | B-737-900WL | MD-80 | |
| DOM 34 | Existing | III | 17 | B-737-900WL | MD-80 | |
| DOM 35 | Existing | III | 18 | B-737-900WL | MD-80 | |
| DOM 36 | Existing | III | 19 | B-737-900WL | MD-80 | |

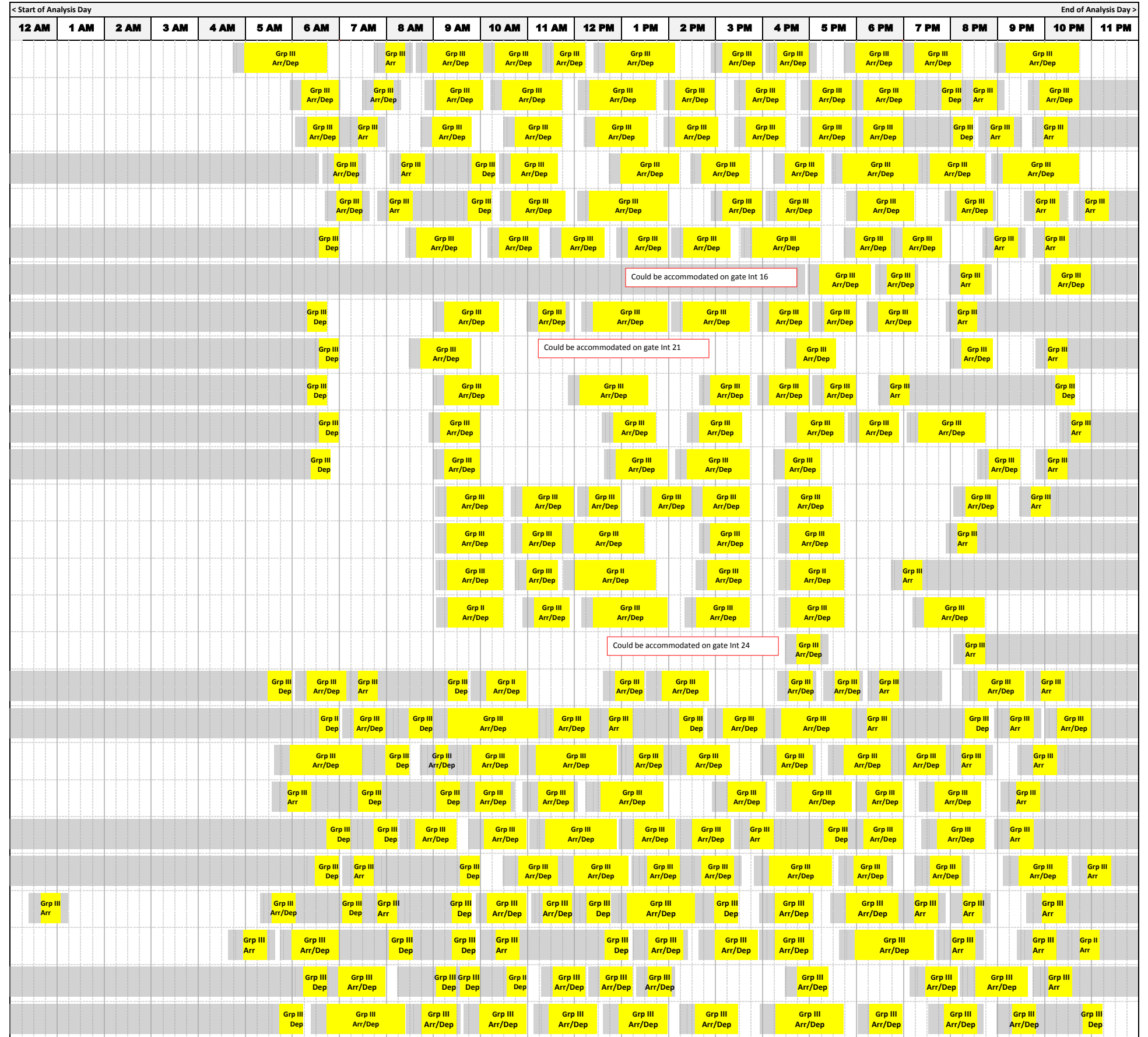

| Arr + Dep | Turns |
|-----------|-------|
| 21 | 10.5 |
| 22 | 11 |
| 20 | 10 |
| 18 | 9 |
| 18 | 9 |
| 19 | 9.5 |
| 7 | 3.5 |
| 16 | 8 |
| 8 | 4 |
| 13 | 6.5 |
| 14 | 7 |
| 12 | 6 |
| 15 | 7.5 |
| 11 | 5.5 |
| 11 | 5.5 |
| 12 | 6 |
| 3 | 1.5 |
| 19 | 9.5 |
| 19 | 9.5 |
| 21 | 10.5 |
| 18 | 9 |
| 19 | 9.5 |
| 20 | 10 |
| 21 | 10.5 |
| 18 | 9 |
| 19 | 9.5 |
| 22 | 11 |

2029 Ramp Chart

| Position | Based on 'Mix B' assuming the largest aircraft size mix | Jet Type | Jet Type Count | Max Wingspan Acft | Max Length Acft | Depend Group |
|----------|---|----------|----------------|-------------------|-----------------|--------------|
| DOM 37 | Existing | III | 20 | B-737-900WL | MD-80 | |
| DOM 38 | Existing | III | 21 | B-737-900WL | MD-80 | |
| DOM 39 | Existing | III | 22 | B-737-900WL | MD-80 | |
| DOM 40 | Existing | III | 23 | B-737-900WL | MD-80 | |
| DOM 41 | Existing | III | 24 | B-737-900WL | MD-80 | |
| DOM 42 | Existing | III | 25 | B-737-900WL | MD-80 | |
| DOM 43 | Existing | III | 26 | B-737-900WL | MD-80 | |
| DOM 44 | Existing | III | 27 | B-737-900WL | MD-80 | |
| DOM 45 | Existing | III | 28 | B-737-900WL | MD-80 | |
| DOM 46 | Existing | III | 29 | B-737-900WL | MD-80 | |
| DOM 47 | Existing | III | 30 | B-737-900WL | MD-80 | |
| DOM 48 | Existing | III | 31 | B-737-900WL | MD-80 | |
| DOM 49 | Existing | III | 32 | B-737-900WL | MD-80 | |
| DOM 50 | Existing | III | 33 | B-737-900WL | MD-80 | |
| DOM 51 | Existing | III | 34 | B-737-900WL | MD-80 | |
| DOM 52 | Existing | III | 35 | B-737-900WL | MD-80 | |
| DOM 53 | Existing | III | 36 | B-737-900WL | MD-80 | |
| DOM 54 | Not Needed | | | E-190 | CRJ-900 | |
| DOM 55 | Existing | RJ | 9 | E-190 | CRJ-900 | |
| DOM 56 | Existing | RJ | 10 | E-190 | CRJ-900 | |
| DOM 57 | Existing | RJ | 11 | E-190 | CRJ-900 | |
| DOM 58 | Existing | RJ | 12 | E-190 | CRJ-900 | |
| DOM 59 | Existing | RJ | 13 | E-190 | CRJ-900 | |
| DOM 60 | Existing | RJ | 14 | E-190 | CRJ-900 | |
| DOM 61 | Existing | RJ | 15 | E-190 | CRJ-900 | |
| DOM 62 | Existing | RJ | 16 | E-190 | CRJ-900 | |
| DOM 63 | Existing | RJ | 17 | E-190 | CRJ-900 | |

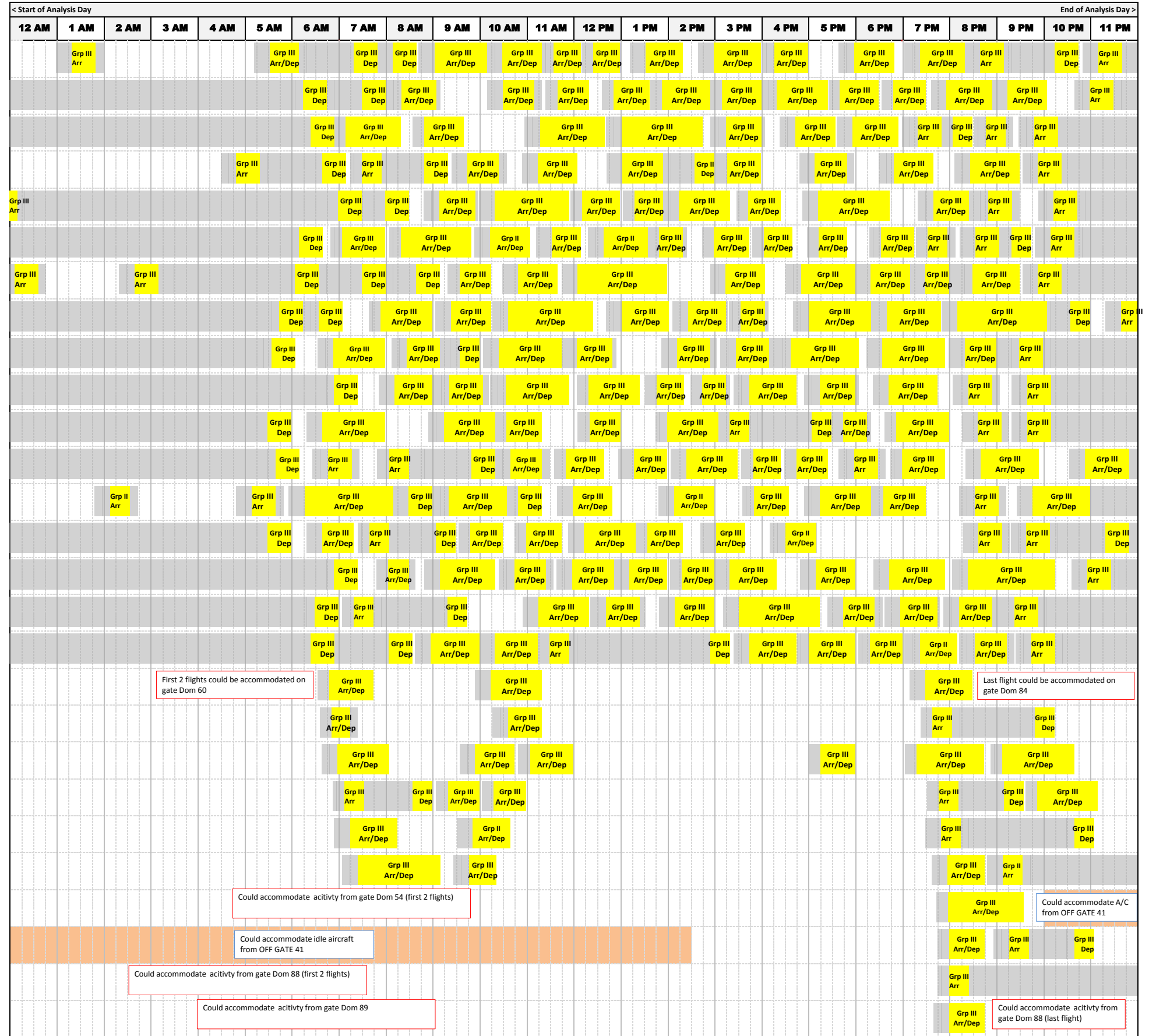

| Arr + Dep | Turns |
|-----------|-------|
| 26 | 13 |
| 25 | 12.5 |
| 19 | 9.5 |
| 20 | 10 |
| 21 | 10.5 |
| 25 | 12.5 |
| 22 | 11 |
| 22 | 11 |
| 21 | 10.5 |
| 21 | 10.5 |
| 19 | 9.5 |
| 23 | 11.5 |
| 21 | 10.5 |
| 20 | 10 |
| 22 | 11 |
| 18 | 9 |
| 19 | 9.5 |
| 6 | 3 |
| 6 | 3 |
| 12 | 6 |
| 10 | 5 |
| 6 | 3 |
| 7 | 3.5 |
| 2 | 1 |
| 4 | 2 |
| 1 | 0.5 |
| 2 | 1 |

2029 Ramp Chart

| Position | Based on 'Mix B' assuming the largest aircraft size mix | Jet Type | Jet Type Count | Max Wingspan Acft | Max Length Acft | Depend Group |
|----------|---|----------|----------------|-------------------|-----------------|--------------|
| DOM 64 | Existing | RJ | 18 | E-190 | CRJ-900 | |
| DOM 65 | Existing | RJ | 19 | E-190 | CRJ-900 | |
| DOM 66 | Not Needed | | | E-190 | CRJ-900 | |
| DOM 67 | Existing | RJ | 20 | E-190 | CRJ-900 | |
| DOM 68 | New | | | E-190 | CRJ-900 | |
| DOM 69 | Existing | V | 2 | B-777-300ER | | |
| DOM 70 | Existing | IV | 6 | B-767-300ERWL | | |
| DOM 71 | Existing | IV | 7 | B-767-300ERWL | | |
| DOM 72 | Existing | IV | 8 | B-767-300ERWL | | |
| DOM 73 | Existing | III | 37 | B-737-900WL | MD-80 | |
| DOM 74 | Existing | III | 38 | B-737-900WL | MD-80 | |
| DOM 75 | Existing | III | 39 | B-737-900WL | MD-80 | |
| DOM 76 | Existing | III | 40 | B-737-900WL | MD-80 | |
| DOM 77 | New | | | B-737-900WL | MD-80 | |
| DOM 78 | New | | | B-737-900WL | MD-80 | |
| DOM 79 | New | | | B-737-900WL | MD-80 | |
| DOM 80 | New | | | B-737-900WL | MD-80 | |
| DOM 81 | New | | | B-737-900WL | MD-80 | |
| DOM 82 | New | | | B-737-900WL | MD-80 | |
| DOM 83 | New | | | B-737-900WL | MD-80 | |
| DOM 84 | New | | | B-737-900WL | MD-80 | |
| DOM 85 | New | | | B-737-900WL | MD-80 | |
| DOM 86 | New | | | B-737-900WL | MD-80 | |
| DOM 87 | New | | | B-737-900WL | MD-80 | |
| DOM 88 | Not Needed | | | E-190 | CRJ-900 | |
| DOM 89 | Not Needed | | | E-190 | CRJ-900 | |

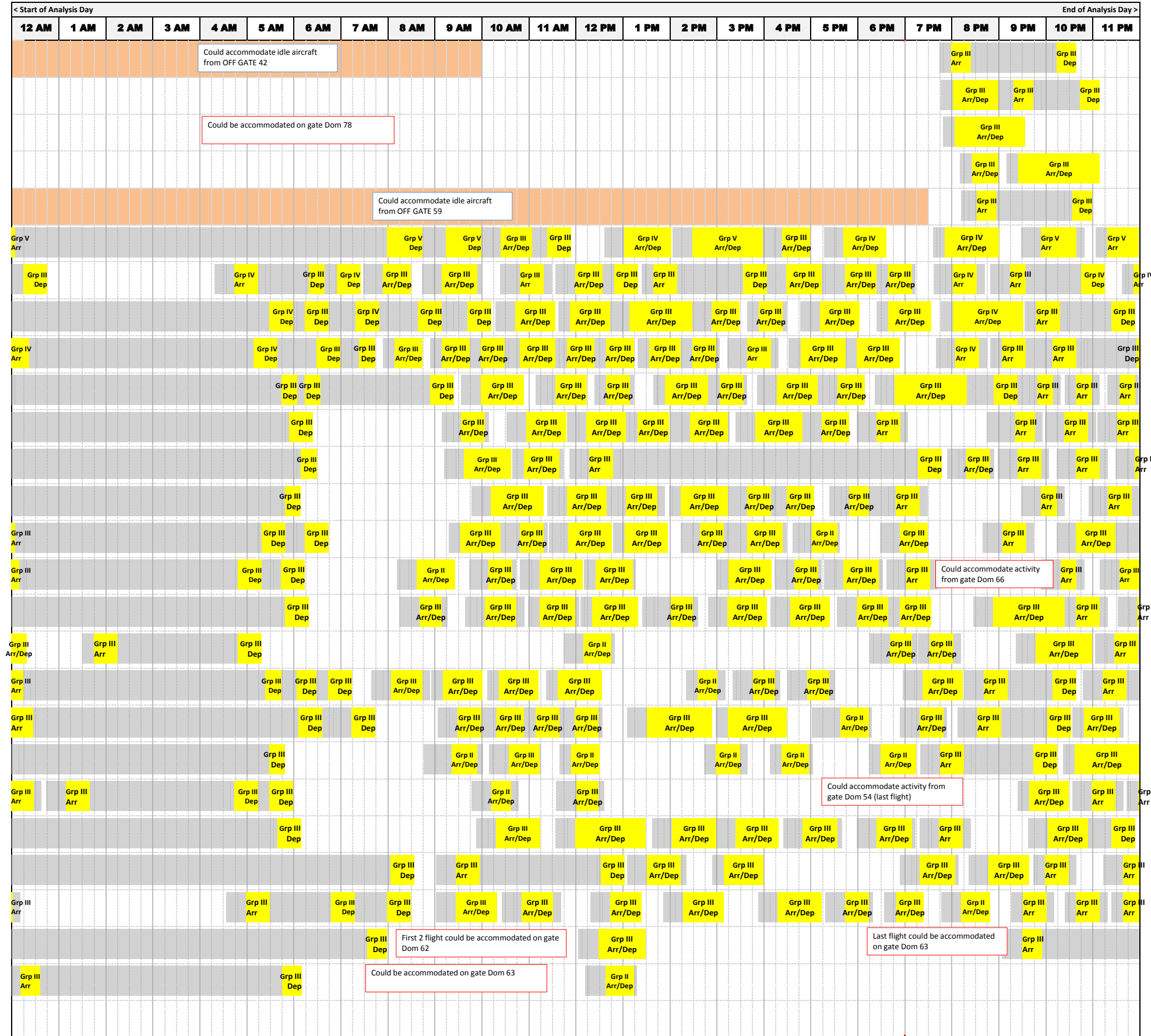

| Arr + Dep | Turns |
|-----------|-------|
| 2 | 1 |
| 4 | 2 |
| 2 | 1 |
| 4 | 2 |
| 2 | 1 |
| 18 | 9 |
| 24 | 12 |
| 23 | 11.5 |
| 29 | 14.5 |
| 23 | 11.5 |
| 19 | 9.5 |
| 12 | 6 |
| 18 | 9 |
| 22 | 11 |
| 20 | 10 |
| 23 | 11.5 |
| 13 | 6.5 |
| 23 | 11.5 |
| 23 | 11.5 |
| 17 | 8.5 |
| 12 | 6 |
| 17 | 8.5 |
| 13 | 6.5 |
| 23 | 11.5 |
| 4 | 2 |
| 4 | 2 |

2029 Ramp Chart

| Position | Based on 'Mix B' assuming the largest aircraft size mix | Jet Type | Jet Type Count | Max Wingspan Acft | Max Length Acft | Depend Group |
|-------------|---|----------|----------------|-------------------|-----------------|--------------|
| OFF GATE 1 | RON Offgate | | | B-777-300ER | | |
| OFF GATE 2 | RON FIS gate | | | B-767-300ERWL | | |
| OFF GATE 3 | RON Offgate | | | B-767-300ERWL | | |
| OFF GATE 4 | RON Offgate | | | B-767-300ERWL | | |
| OFF GATE 5 | RON Offgate | | | B-737-900WL | MD-80 | |
| OFF GATE 6 | RON FIS gate | | | B-737-900WL | MD-80 | |
| OFF GATE 7 | RON FIS gate | | | B-737-900WL | MD-80 | |
| OFF GATE 8 | RON FIS gate | | | B-737-900WL | MD-80 | |
| OFF GATE 9 | RON FIS gate | | | B-737-900WL | MD-80 | |
| OFF GATE 10 | RON FIS gate | | | B-737-900WL | MD-80 | |
| OFF GATE 11 | RON FIS gate | | | B-737-900WL | MD-80 | |
| OFF GATE 12 | RON FIS gate | | | B-737-900WL | MD-80 | |
| OFF GATE 13 | RON Offgate | | | B-737-900WL | MD-80 | |
| OFF GATE 14 | RON Offgate | | | B-737-900WL | MD-80 | |
| OFF GATE 15 | RON Offgate | | | B-737-900WL | MD-80 | |
| OFF GATE 16 | RON Offgate | | | B-737-900WL | MD-80 | |
| OFF GATE 17 | RON Offgate | | | B-737-900WL | MD-80 | |
| OFF GATE 18 | RON Offgate | | | B-737-900WL | MD-80 | |
| OFF GATE 19 | RON Offgate | | | B-737-900WL | MD-80 | |
| OFF GATE 20 | RON Offgate | | | B-737-900WL | MD-80 | |
| OFF GATE 21 | RON Offgate | | | B-737-900WL | MD-80 | |
| OFF GATE 22 | RON Offgate | | | B-737-900WL | MD-80 | |
| OFF GATE 23 | RON Offgate | | | B-737-900WL | MD-80 | |
| OFF GATE 24 | RON Offgate | | | B-737-900WL | MD-80 | |

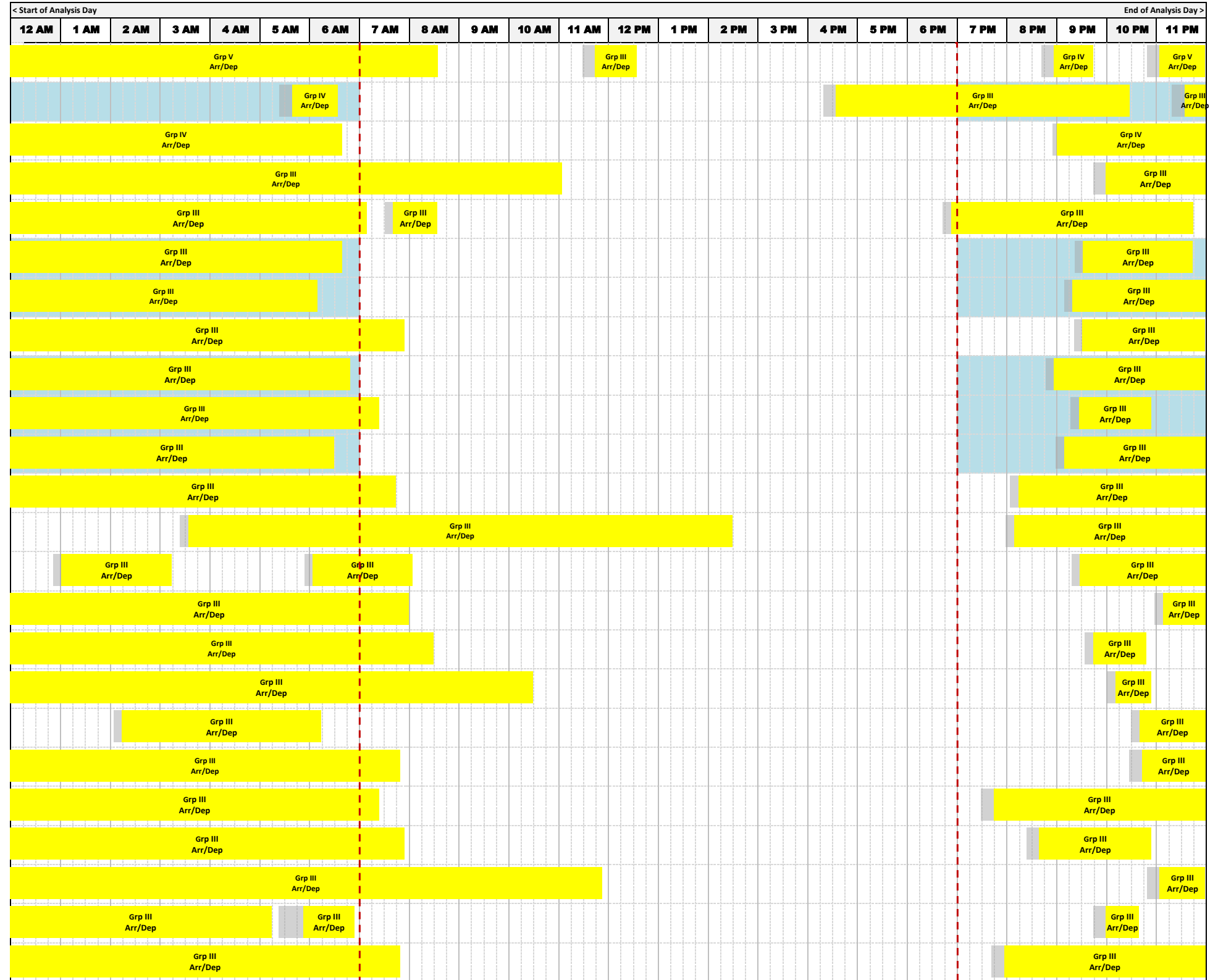

| Arr + Dep | Turns |
|-----------|-------|
| 6 | 3 |
| 5 | 2.5 |
| 3 | 1.5 |
| 2 | 1 |
| 5 | 2.5 |
| 3 | 1.5 |
| 2 | 1 |
| 2 | 1 |
| 2 | 1 |
| 3 | 1.5 |
| 3 | 1.5 |
| 2 | 1 |
| 3 | 1.5 |
| 5 | 2.5 |
| 2 | 1 |
| 3 | 1.5 |
| 3 | 1.5 |
| 3 | 1.5 |
| 2 | 1 |
| 2 | 1 |
| 3 | 1.5 |
| 2 | 1 |
| 6 | 3 |
| 2 | 1 |

2029 Ramp Chart

| Position | Based on 'Mix B' assuming the largest aircraft size mix | Jet Type | Jet Type Count | Max Wingspan Acft | Max Length Acft | Depend Group | < Start of Analysis Day | | | | | | | | | | | | | | | | | | | | | | | | End of Analysis Day > | | | | | Arr + Dep | Turns |
|-------------|---|----------|----------------|-------------------|-----------------|--------------|-------------------------|------|------|------|------|------|------|------|------|------|-------|-------|-------|------|------|------|------|-----------------|------|------|------|------|-------|-------|-----------------------|-----|--|--|--|-----------|-------|
| | | | | | | | 12 AM | 1 AM | 2 AM | 3 AM | 4 AM | 5 AM | 6 AM | 7 AM | 8 AM | 9 AM | 10 AM | 11 AM | 12 PM | 1 PM | 2 PM | 3 PM | 4 PM | 5 PM | 6 PM | 7 PM | 8 PM | 9 PM | 10 PM | 11 PM | | | | | | | |
| OFF GATE 25 | RON Offgate | | | B-737-900WL | MD-80 | | Grp III Arr/Dep | | | | | | | | | | | | | | | | | Grp III Arr/Dep | | | | | 2 | 1 | | | | | | | |
| OFF GATE 26 | RON FIS gate | | | B-737-900WL | MD-80 | | Grp III Arr/Dep | | | | | | | | | | | | | | | | | Grp III Arr/Dep | | | | | 3 | 1.5 | | | | | | | |
| OFF GATE 27 | RON FIS gate | | | B-737-900WL | MD-80 | | Grp III Arr/Dep | | | | | | | | | | | | | | | | | Grp III Arr/Dep | | | | | 2 | 1 | | | | | | | |
| OFF GATE 28 | RON FIS gate | | | B-737-900WL | MD-80 | | Grp III Arr/Dep | | | | | | | | | | | | | | | | | Grp III Arr/Dep | | | | | 2 | 1 | | | | | | | |
| OFF GATE 29 | RON Offgate | | | B-737-900WL | MD-80 | | Grp III Arr/Dep | | | | | | | | | | | | | | | | | Grp III Arr/Dep | | | | | 2 | 1 | | | | | | | |
| OFF GATE 30 | RON Offgate | | | B-737-900WL | MD-80 | | Grp III Arr/Dep | | | | | | | | | | | | | | | | | Grp III Arr/Dep | | | | | 3 | 1.5 | | | | | | | |
| OFF GATE 31 | RON Offgate | | | B-737-900WL | MD-80 | | Grp III Arr/Dep | | | | | | | | | | | | | | | | | Grp III Arr/Dep | | | | | 2 | 1 | | | | | | | |
| OFF GATE 32 | RON Offgate | | | B-737-900WL | MD-80 | | Grp III Arr/Dep | | | | | | | | | | | | | | | | | Grp III Arr/Dep | | | | | 3 | 1.5 | | | | | | | |
| OFF GATE 33 | RON Offgate | | | B-737-900WL | MD-80 | | Grp III Arr/Dep | | | | | | | | | | | | | | | | | Grp III Arr/Dep | | | | | 3 | 1.5 | | | | | | | |
| OFF GATE 34 | RON Offgate | | | B-737-900WL | MD-80 | | Grp III Arr/Dep | | | | | | | | | | | | | | | | | Grp III Arr/Dep | | | | | 4 | 2 | | | | | | | |
| OFF GATE 35 | RON Offgate | | | B-737-900WL | MD-80 | | Grp III Arr/Dep | | | | | | | | | | | | | | | | | Grp III Arr/Dep | | | | | 3 | 1.5 | | | | | | | |
| OFF GATE 36 | RON Offgate | | | B-737-900WL | MD-80 | | Grp III Arr/Dep | | | | | | | | | | | | | | | | | | | | | | | | 2 | 1 | | | | | |
| OFF GATE 37 | RON Offgate | | | B-737-900WL | MD-80 | | Grp III Arr/Dep | | | | | | | | | | | | | | | | | Grp III Arr/Dep | | | | | 3 | 1.5 | | | | | | | |
| OFF GATE 38 | RON Offgate | | | B-737-900WL | MD-80 | | Grp III Arr/Dep | | | | | | | | | | | | | | | | | | | | | | | | 1 | 0.5 | | | | | |
| OFF GATE 39 | RON Offgate | | | E-190 | CRJ-900 | | Grp III Arr/Dep | | | | | | | | | | | | | | | | | Grp III Arr/Dep | | | | | 5 | 2.5 | | | | | | | |
| OFF GATE 40 | RON Offgate | | | E-190 | CRJ-900 | | Grp II Arr/Dep | | | | | | | | | | | | | | | | | Grp III Arr/Dep | | | | | 3 | 1.5 | | | | | | | |
| OFF GATE 41 | RON Offgate | | | E-190 | CRJ-900 | | Grp II Arr/Dep | | | | | | | | | | | | | | | | | Grp III Arr/Dep | | | | | 3 | 1.5 | | | | | | | |
| OFF GATE 42 | RON Offgate | | | E-190 | CRJ-900 | | Grp III Arr/Dep | | | | | | | | | | | | | | | | | Grp III Arr/Dep | | | | | 4 | 2 | | | | | | | |
| OFF GATE 43 | RON Offgate | | | E-190 | CRJ-900 | | Grp III Arr/Dep | | | | | | | | | | | | | | | | | Grp III Arr/Dep | | | | | 1 | 0.5 | | | | | | | |
| OFF GATE 44 | RON Offgate | | | B-777-300ER | | | Grp V Arr/Dep | | | | | | | | | | | | | | | | | Grp IV Arr/Dep | | | | | 3 | 1.5 | | | | | | | |
| OFF GATE 45 | RON Offgate | | | B-777-300ER | | | Grp V Arr/Dep | | | | | | | | | | | | | | | | | | | | | | | | 2 | 1 | | | | | |
| OFF GATE 46 | RON Offgate | | | B-777-300ER | | | Grp IV Arr/Dep | | | | | | | | | | | | | | | | | Grp V Arr/Dep | | | | | 5 | 2.5 | | | | | | | |
| OFF GATE 47 | RON Offgate | | | B-767-300ERWL | | | Grp IV Arr/Dep | | | | | | | | | | | | | | | | | Grp III Arr/Dep | | | | | 2 | 1 | | | | | | | |
| OFF GATE 48 | RON FIS gate | | | B-767-300ERWL | | | Grp III Arr/Dep | | | | | | | | | | | | | | | | | Grp IV Arr/Dep | | | | | 4 | 2 | | | | | | | |
| OFF GATE 49 | RON FIS gate | | | B-767-300ERWL | | | Grp III Arr/Dep | | | | | | | | | | | | | | | | | Grp IV Arr/Dep | | | | | 3 | 1.5 | | | | | | | |
| OFF GATE 50 | RON FIS gate | | | B-737-900WL | MD-80 | | Grp III Arr/Dep | | | | | | | | | | | | | | | | | Grp III Arr/Dep | | | | | 7 | 3.5 | | | | | | | |
| OFF GATE 51 | RON FIS gate | | | B-737-900WL | MD-80 | | Grp III Arr/Dep | | | | | | | | | | | | | | | | | Grp III Arr/Dep | | | | | 3 | 1.5 | | | | | | | |

2029 Ramp Chart

| Position | Based on 'Mix B' assuming the largest aircraft size mix | Jet Type | Jet Type Count | Max Wingspan Acft | Max Length Acft | Depend Group |
|-------------|---|----------|----------------|-------------------|-----------------|--------------|
| OFF GATE 52 | RON FIS gate | | | B-737-900WL | MD-80 | |
| OFF GATE 53 | RON Offgate | | | B-737-900WL | MD-80 | |
| OFF GATE 54 | RON Offgate | | | B-737-900WL | MD-80 | |
| OFF GATE 55 | RON Offgate | | | B-737-900WL | MD-80 | |
| OFF GATE 56 | RON Offgate | | | B-737-900WL | MD-80 | |
| OFF GATE 57 | RON Offgate | | | B-737-900WL | MD-80 | |
| OFF GATE 58 | RON Offgate | | | E-190 | CRJ-900 | |
| OFF GATE 59 | RON Offgate | | | E-190 | CRJ-900 | |

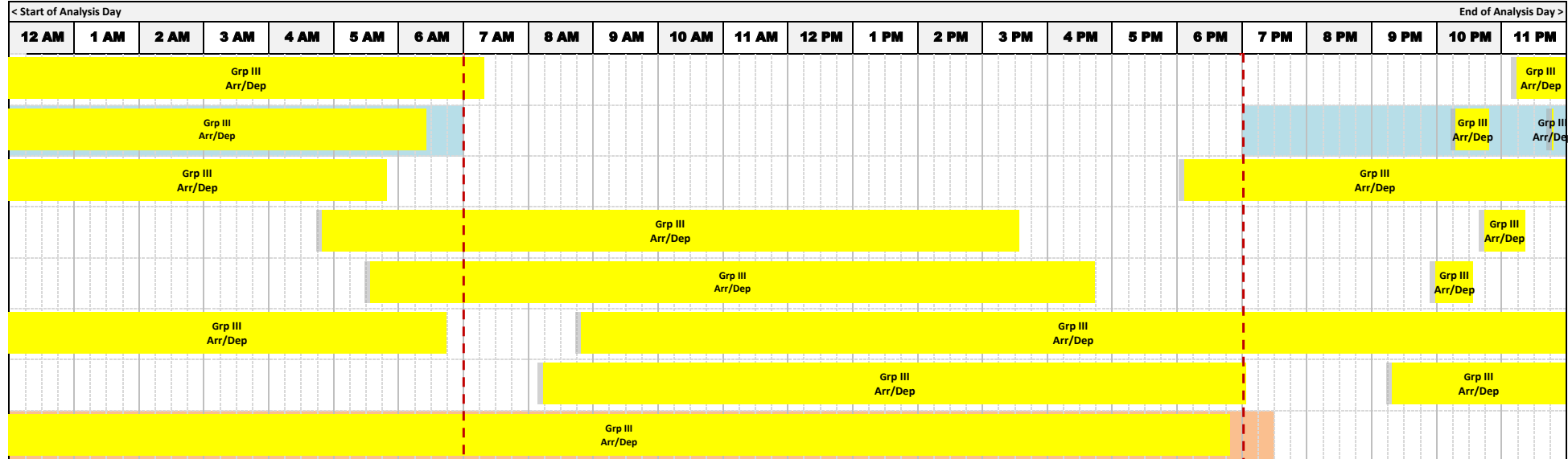

| Arr + Dep | Turns |
|-----------|-------|
| 2 | 1 |
| 6 | 3 |
| 2 | 1 |
| 4 | 2 |
| 4 | 2 |
| 2 | 1 |
| 3 | 1.5 |
| 1 | 0.5 |

2034 Ramp Chart

| Position | Based on 'Mix B' assuming the largest aircraft size mix | Jet Type | Jet Type Count | Max Wingspan Acft | Max Length Acft | Depend Group |
|----------|---|----------|----------------|-------------------|-----------------|--------------|
| INT 1 | Existing | V | 1 | B-777-300ER | | |
| INT 2 | Existing | V | 2 | B-777-300ER | | |
| INT 3 | Existing | V | 3 | B-777-300ER | | |
| INT 4 | Existing | V | 4 | B-777-300ER | | |
| INT 5 | Existing | V | 5 | B-777-300ER | | |
| INT 6 | Existing | V | 6 | B-777-300ER | | |
| INT 7 | Existing | V | 7 | B-777-300ER | | |
| INT 8 | Existing | V | 8 | B-777-300ER | | |
| INT 9 | Existing | V | 9 | B-777-300ER | | |
| INT 10 | Existing | V | 10 | B-777-300ER | | |
| INT 11 | New | | | B-777-300ER | | |
| INT 12 | New | | | B-777-300ER | | |
| INT 13 | New | | | B-777-300ER | | |
| INT 14 | New | | | B-777-300ER | | |
| INT 15 | New | | | B-777-300ER | | |
| INT 16 | New | | | B-777-300ER | | |
| INT 17 | New | | | B-777-300ER | | |
| INT 18 | New | | | B-777-300ER | | |
| INT 19 | New | | | B-777-300ER | | |
| INT 20 | New | | | B-777-300ER | | |
| INT 21 | New | | | B-777-300ER | | |
| INT 22 | New | | | B-777-300ER | | |
| INT 23 | New | | | B-777-300ER | | |
| INT 24 | New | | | B-777-300ER | | |
| INT 25 | New | | | B-777-300ER | | |
| INT 26 | New | | | B-777-300ER | | |
| INT 27 | New | | | B-777-300ER | | |

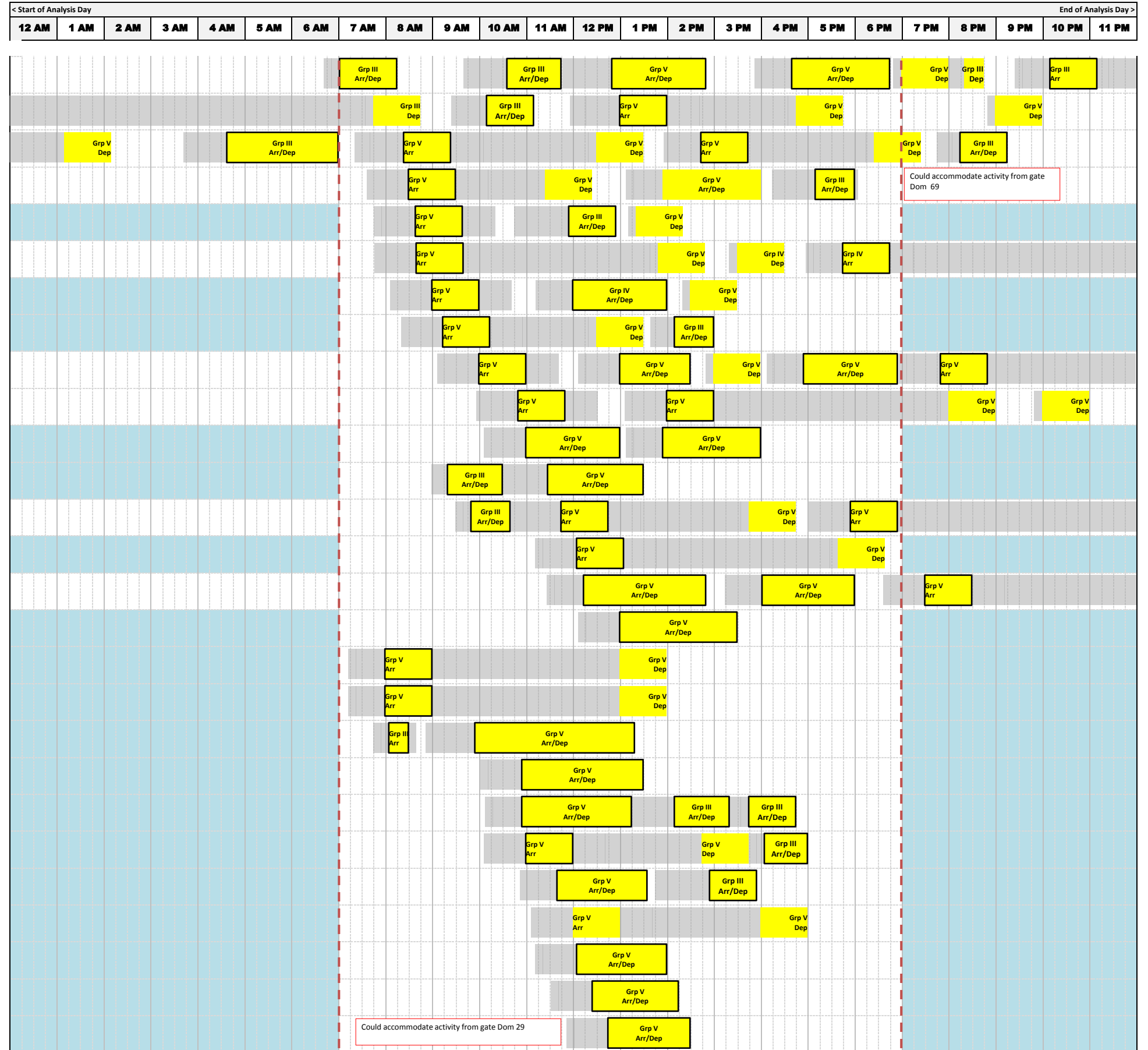

| Arr + Dep | Turns |
|-----------|-------|
| 11 | 5.5 |
| 6 | 3 |
| 9 | 4.5 |
| 6 | 3 |
| 4 | 2 |
| 4 | 2 |
| 4 | 2 |
| 4 | 2 |
| 7 | 3.5 |
| 4 | 2 |
| 4 | 2 |
| 4 | 2 |
| 5 | 2.5 |
| 2 | 1 |
| 5 | 2.5 |
| 2 | 1 |
| 2 | 1 |
| 2 | 1 |
| 3 | 1.5 |
| 2 | 1 |
| 6 | 3 |
| 4 | 2 |
| 4 | 2 |
| 2 | 1 |
| 2 | 1 |
| 2 | 1 |

2034 Ramp Chart

| Position | Based on 'Mix B' assuming the largest aircraft size mix | Jet Type | Jet Type Count | Max Wingspan Acft | Max Length Acft | Depend Group |
|----------|---|----------|----------------|-------------------|-----------------|--------------|
| INT 28 | Existing | IV | 1 | B-737-900WL | MD-80 | |
| INT 29 | Existing | IV | 2 | B-737-900WL | MD-80 | |

| DOM | Existing | Jet Type | Jet Type Count | Max Wingspan Acft | Max Length Acft | Depend Group |
|--------|------------|----------|----------------|-------------------|-----------------|--------------|
| DOM 1 | Existing | V | 1 | B-777-300ER | | |
| DOM 2 | Existing | V | 2 | B-777-300ER | | |
| DOM 3 | Existing | IV | 1 | B-767-300ERWL | | |
| DOM 4 | Existing | IV | 2 | B-767-300ERWL | | |
| DOM 5 | Existing | IV | 3 | B-767-300ERWL | | |
| DOM 6 | Existing | III | 1 | B-737-900WL | MD-80 | |
| DOM 7 | Existing | III | 2 | B-737-900WL | MD-80 | |
| DOM 8 | Existing | III | 3 | B-737-900WL | MD-80 | |
| DOM 9 | Existing | III | 4 | B-737-900WL | MD-80 | |
| DOM 10 | Existing | III | 5 | B-737-900WL | MD-80 | |
| DOM 11 | Existing | III | 6 | B-737-900WL | MD-80 | |
| DOM 12 | Existing | III | 7 | B-737-900WL | MD-80 | |
| DOM 13 | Existing | III | 8 | B-737-900WL | MD-80 | |
| DOM 14 | Existing | III | 9 | B-737-900WL | MD-80 | |
| DOM 15 | Existing | III | 10 | B-737-900WL | MD-80 | |
| DOM 16 | Existing | III | 11 | B-737-900WL | MD-80 | |
| DOM 17 | Existing | III | 12 | B-737-900WL | MD-80 | |
| DOM 18 | Existing | III | 13 | B-737-900WL | MD-80 | |
| DOM 19 | Not Needed | | | B-737-900WL | MD-80 | |
| DOM 20 | Existing | III | 14 | B-737-900WL | MD-80 | |
| DOM 21 | Existing | III | 15 | B-737-900WL | MD-80 | |
| DOM 22 | Not Needed | | | B-737-900WL | MD-80 | |
| DOM 23 | Existing | III | 16 | B-737-900WL | MD-80 | |
| DOM 24 | Existing | III | 17 | B-737-900WL | MD-80 | |

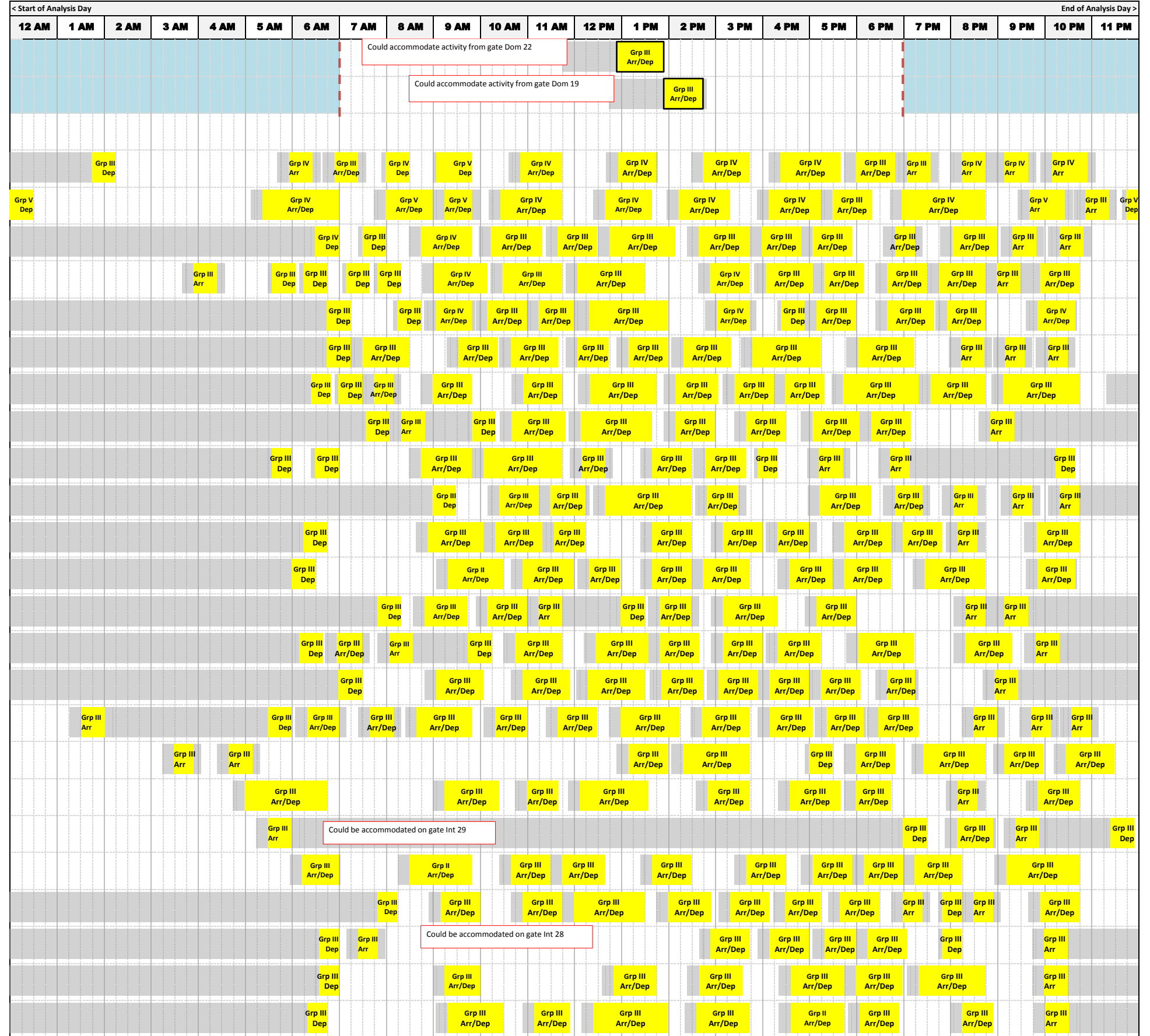

| Arr + Dep | Turns |
|-----------|-------|
| 2 | 1 |
| 2 | 1 |
| 20 | 10 |
| 22 | 11 |
| 22 | 11 |
| 24 | 12 |
| 21 | 10.5 |
| 20 | 10 |
| 22 | 11 |
| 16 | 8 |
| 16 | 8 |
| 16 | 8 |
| 20 | 10 |
| 19 | 9.5 |
| 15 | 7.5 |
| 20 | 10 |
| 18 | 9 |
| 25 | 12.5 |
| 15 | 7.5 |
| 17 | 8.5 |
| 6 | 3 |
| 20 | 10 |
| 20 | 10 |
| 12 | 6 |
| 14 | 7 |
| 16 | 8 |

2034 Ramp Chart

| Position | Based on 'Mix B' assuming the largest aircraft size mix | Jet Type | Jet Type Count | Max Wingspan Acft | Max Length Acft | Depend Group |
|----------|---|----------|----------------|-------------------|-----------------|--------------|
| DOM 25 | Existing | III | 18 | B-737-900WL | MD-80 | |
| DOM 26 | Existing | III | 19 | B-737-900WL | MD-80 | |
| DOM 27 | Existing | III | 20 | B-737-900WL | MD-80 | |
| DOM 28 | Existing | III | 21 | B-737-900WL | MD-80 | |
| DOM 29 | Not Needed | | | B-737-900WL | MD-80 | |
| DOM 30 | Existing | III | 22 | B-737-900WL | MD-80 | |
| DOM 31 | Existing | III | 23 | B-737-900WL | MD-80 | |
| DOM 32 | Existing | III | 24 | B-737-900WL | MD-80 | |
| DOM 33 | Existing | III | 25 | B-737-900WL | MD-80 | |
| DOM 34 | Existing | III | 26 | B-737-900WL | MD-80 | |
| DOM 35 | Existing | III | 27 | B-737-900WL | MD-80 | |
| DOM 36 | Existing | III | 28 | B-737-900WL | MD-80 | |
| DOM 37 | Existing | III | 29 | B-737-900WL | MD-80 | |
| DOM 38 | Existing | III | 30 | B-737-900WL | MD-80 | |
| DOM 39 | Existing | III | 31 | B-737-900WL | MD-80 | |
| DOM 40 | Existing | III | 32 | B-737-900WL | MD-80 | |
| DOM 41 | Existing | III | 33 | B-737-900WL | MD-80 | |
| DOM 42 | Existing | III | 34 | B-737-900WL | MD-80 | |
| DOM 43 | Existing | III | 35 | B-737-900WL | MD-80 | |
| DOM 44 | Existing | III | 36 | B-737-900WL | MD-80 | |
| DOM 45 | Existing | III | 37 | B-737-900WL | MD-80 | |
| DOM 46 | Existing | III | 38 | B-737-900WL | MD-80 | |
| DOM 47 | Existing | III | 39 | B-737-900WL | MD-80 | |
| DOM 48 | Existing | III | 40 | B-737-900WL | MD-80 | |
| DOM 49 | New | | | B-737-900WL | MD-80 | |
| DOM 50 | New | | | B-737-900WL | MD-80 | |
| DOM 51 | New | | | B-737-900WL | MD-80 | |

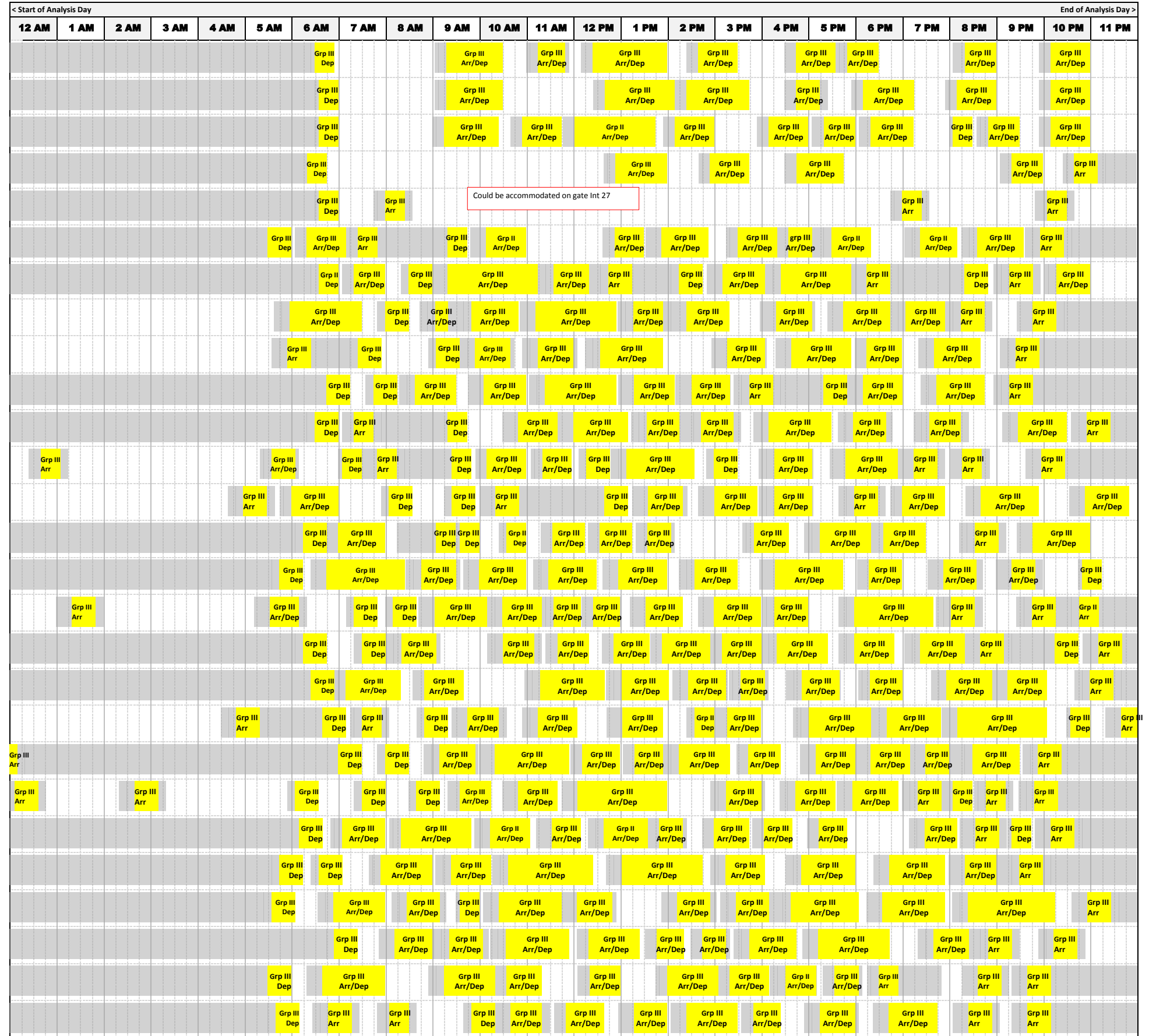

| Arr + Dep | Turns |
|-----------|-------|
| 17 | 8.5 |
| 15 | 7.5 |
| 20 | 10 |
| 10 | 5 |
| 4 | 2 |
| 22 | 11 |
| 19 | 9.5 |
| 21 | 10.5 |
| 18 | 9 |
| 19 | 9.5 |
| 20 | 10 |
| 21 | 10.5 |
| 21 | 10.5 |
| 22 | 11 |
| 24 | 12 |
| 23 | 11.5 |
| 22 | 11 |
| 21 | 10.5 |
| 24 | 12 |
| 19 | 9.5 |
| 21 | 10.5 |
| 21 | 10.5 |
| 20 | 10 |
| 20 | 10 |

2034 Ramp Chart

| Position | Based on 'Mix B' assuming the largest aircraft size mix | Jet Type | Jet Type Count | Max Wingspan Acft | Max Length Acft | Depend Group |
|----------|---|----------|----------------|-------------------|-----------------|--------------|
| DOM 52 | Existing | III | 41 | B-737-900WL | MD-80 | |
| DOM 53 | Existing | III | 42 | B-737-900WL | MD-80 | |
| DOM 54 | Existing | III | 43 | B-737-900WL | MD-80 | |
| DOM 55 | Existing | III | 44 | B-737-900WL | MD-80 | |
| DOM 56 | Existing | III | 45 | B-737-900WL | MD-80 | |
| DOM 57 | Existing | RJ | 1 | E-190 | CRJ-900 | |
| DOM 58 | Existing | RJ | 2 | E-190 | CRJ-900 | |
| DOM 59 | Not Needed | | | E-190 | CRJ-900 | |
| DOM 60 | Existing | RJ | 3 | E-190 | CRJ-900 | |
| DOM 61 | Existing | RJ | 4 | E-190 | CRJ-900 | |
| DOM 62 | Existing | RJ | 5 | E-190 | CRJ-900 | |
| DOM 63 | Existing | RJ | 6 | E-190 | CRJ-900 | |
| DOM 64 | Existing | RJ | 7 | E-190 | CRJ-900 | |
| DOM 65 | Existing | RJ | 8 | E-190 | CRJ-900 | |
| DOM 66 | Existing | RJ | 9 | E-190 | CRJ-900 | |
| DOM 67 | Existing | RJ | 10 | E-190 | CRJ-900 | |
| DOM 68 | Existing | RJ | 11 | E-190 | CRJ-900 | |
| DOM 69 | Not Needed | | | E-190 | CRJ-900 | |
| DOM 70 | Not Needed | | | E-190 | CRJ-900 | |
| DOM 71 | Existing | RJ | 12 | E-190 | CRJ-900 | |
| DOM 72 | Existing | V | 3 | B-777-300ER | | |
| DOM 73 | Existing | IV | 4 | B-767-300ERWL | | |
| DOM 74 | Existing | IV | 5 | B-767-300ERWL | | |
| DOM 75 | Existing | IV | 6 | B-767-300ERWL | | |
| DOM 76 | New | | | B-737-900WL | MD-80 | |
| DOM 77 | New | | | B-737-900WL | MD-80 | |
| DOM 78 | New | | | B-737-900WL | MD-80 | |

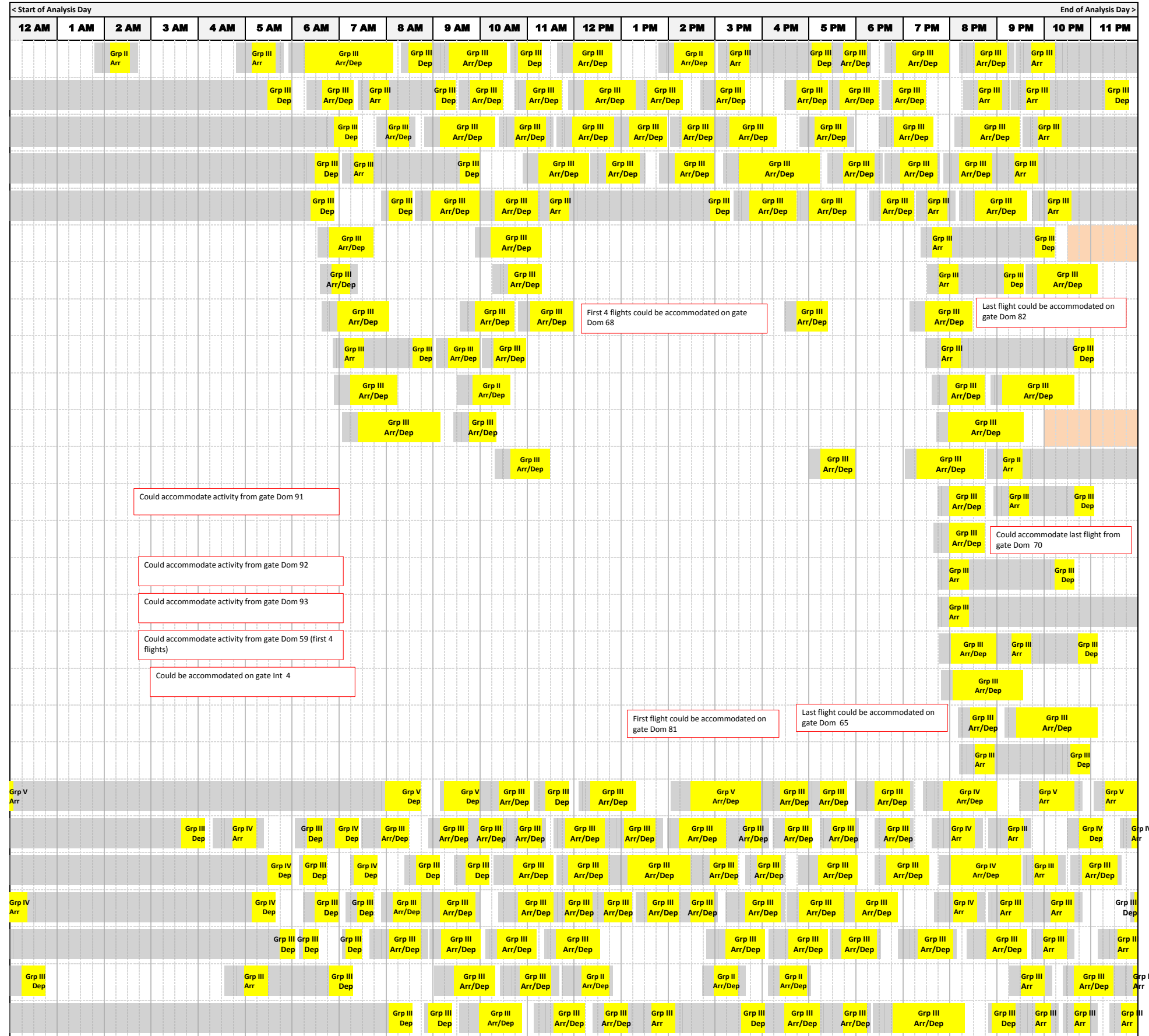

| Arr + Dep | Turns |
|-----------|-------|
| 21 | 10.5 |
| 24 | 12 |
| 22 | 11 |
| 18 | 9 |
| 18 | 9 |
| 6 | 3 |
| 8 | 4 |
| 10 | 5 |
| 8 | 4 |
| 8 | 4 |
| 6 | 3 |
| 7 | 3.5 |
| 4 | 2 |
| 2 | 1 |
| 2 | 1 |
| 1 | 0.5 |
| 4 | 2 |
| 2 | 1 |
| 4 | 2 |
| 2 | 1 |
| 20 | 10 |
| 30 | 15 |
| 24 | 12 |
| 28 | 14 |
| 23 | 11.5 |
| 17 | 8.5 |
| 20 | 10 |

2034 Ramp Chart

| Position | Based on 'Mix B' assuming the largest aircraft size mix | Jet Type | Jet Type Count | Max Wingspan Acft | Max Length Acft | Depend Group |
|----------|---|----------|----------------|-------------------|-----------------|--------------|
| DOM 79 | New | | | B-737-900WL | MD-80 | |
| DOM 80 | New | | | B-737-900WL | MD-80 | |
| DOM 81 | New | | | B-737-900WL | MD-80 | |
| DOM 82 | New | | | B-737-900WL | MD-80 | |
| DOM 83 | New | | | B-737-900WL | MD-80 | |
| DOM 84 | New | | | B-737-900WL | MD-80 | |
| DOM 85 | New | | | B-737-900WL | MD-80 | |
| DOM 86 | New | | | B-737-900WL | MD-80 | |
| DOM 87 | New | | | B-737-900WL | MD-80 | |
| DOM 88 | New | | | B-737-900WL | MD-80 | |
| DOM 89 | New | | | B-737-900WL | MD-80 | |
| DOM 90 | New | | | B-737-900WL | MD-80 | |
| DOM 91 | Not Needed | | | E-190 | CRJ-900 | |
| DOM 92 | Not Needed | | | E-190 | CRJ-900 | |
| DOM 93 | Not Needed | | | E-190 | CRJ-900 | |

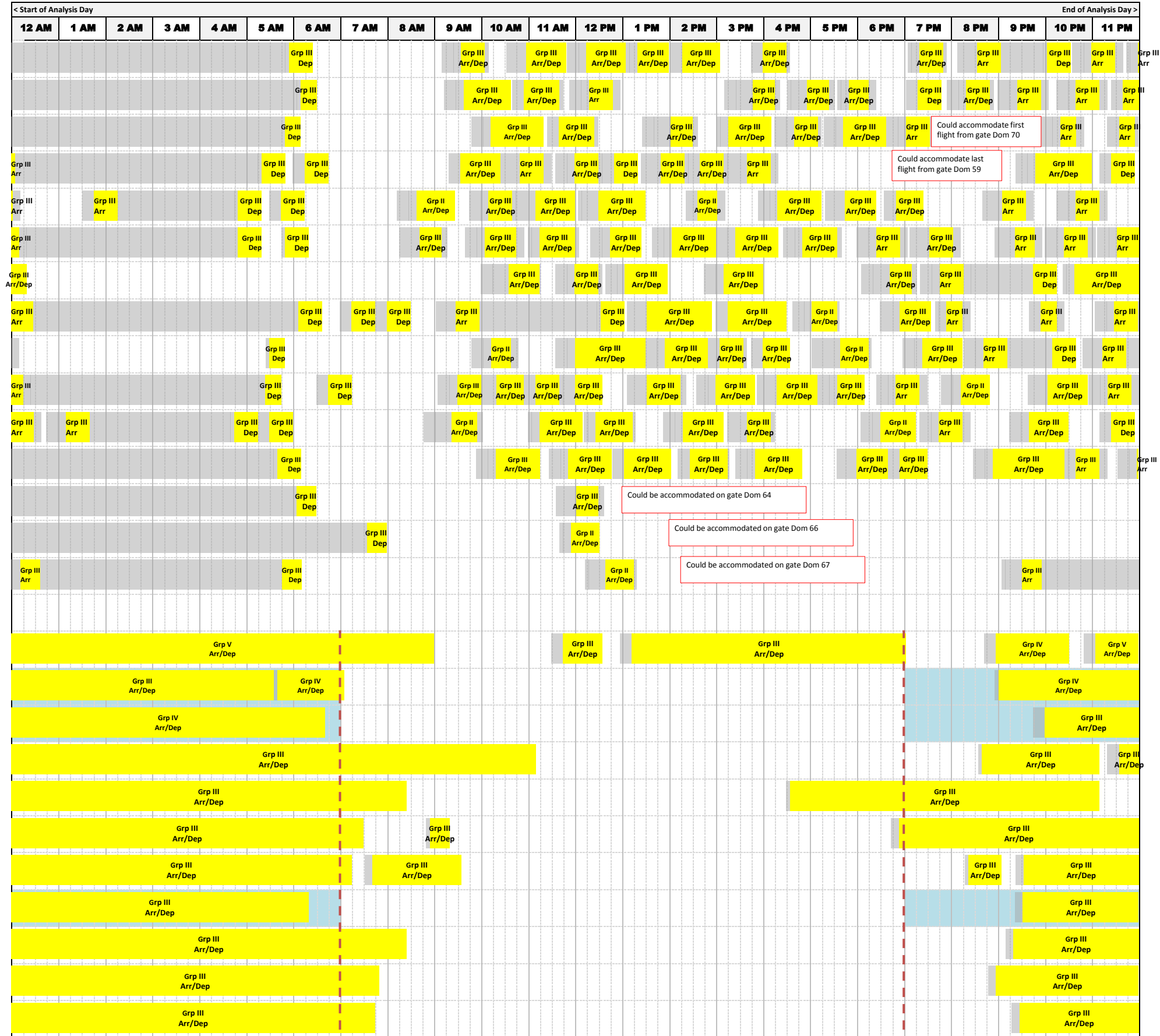

| | | | | | | |
|-------------|--------------|--|--|---------------|-------|--|
| OFF GATE 1 | RON Offgate | | | B-777-300ER | | |
| OFF GATE 2 | RON FIS gate | | | B-767-300ERWL | | |
| OFF GATE 3 | RON FIS gate | | | B-767-300ERWL | | |
| OFF GATE 4 | RON Offgate | | | B-767-300ERWL | | |
| OFF GATE 5 | RON Offgate | | | B-767-300ERWL | | |
| OFF GATE 6 | RON Offgate | | | B-737-900WL | MD-80 | |
| OFF GATE 7 | RON Offgate | | | B-737-900WL | MD-80 | |
| OFF GATE 8 | RON FIS gate | | | B-737-900WL | MD-80 | |
| OFF GATE 9 | RON Offgate | | | B-737-900WL | MD-80 | |
| OFF GATE 10 | RON Offgate | | | B-737-900WL | MD-80 | |
| OFF GATE 11 | RON Offgate | | | B-737-900WL | MD-80 | |

| Arr + Dep | Turns |
|-----------|-------|
| 19 | 9.5 |
| 18 | 9 |
| 16 | 8 |
| 17 | 8.5 |
| 22 | 11 |
| 23 | 11.5 |
| 16 | 8 |
| 17 | 8.5 |
| 18 | 9 |
| 25 | 12.5 |
| 20 | 10 |
| 19 | 9.5 |
| 3 | 1.5 |
| 3 | 1.5 |
| 5 | 2.5 |
| 8 | 4 |
| 4 | 2 |
| 2 | 1 |
| 4 | 2 |
| 3 | 1.5 |
| 4 | 2 |
| 6 | 3 |
| 2 | 1 |
| 2 | 1 |
| 2 | 1 |
| 2 | 1 |

2034 Ramp Chart

| Position | Based on 'Mix B' assuming the largest aircraft size mix | Jet Type | Jet Type Count | Max Wingspan Acft | Max Length Acft | Depend Group | < Start of Analysis Day > < End of Analysis Day > | | | | | | | | | | | | | | | | | | | | | | | | Arr + Dep | Turns |
|-------------|---|----------|----------------|-------------------|-----------------|--------------|---|------|------|------|------|------|------|------|------|------|-------|-------|-------|------|------|------|------|------|------|------|------|------|-------|-------|-----------|-------|
| | | | | | | | 12 AM | 1 AM | 2 AM | 3 AM | 4 AM | 5 AM | 6 AM | 7 AM | 8 AM | 9 AM | 10 AM | 11 AM | 12 PM | 1 PM | 2 PM | 3 PM | 4 PM | 5 PM | 6 PM | 7 PM | 8 PM | 9 PM | 10 PM | 11 PM | | |
| OFF GATE 12 | RON Offgate | | | B-737-900WL | MD-80 | | Grp III Arr/Dep | | | | | | | | | | | | | | | | | | | | | | | | 3 | 1.5 |
| OFF GATE 13 | RON Offgate | | | B-737-900WL | MD-80 | | Grp III Arr/Dep | | | | | | | | | | | | | | | | | | | | | | | | 2 | 1 |
| OFF GATE 14 | RON Offgate | | | B-737-900WL | MD-80 | | Grp III Arr/Dep | | | | | | | | | | | | | | | | | | | | | | | | 3 | 1.5 |
| OFF GATE 15 | RON Offgate | | | B-737-900WL | MD-80 | | Grp III Arr/Dep | | | | | | | | | | | | | | | | | | | | | | | | 5 | 2.5 |
| OFF GATE 16 | RON Offgate | | | B-737-900WL | MD-80 | | Grp III Arr/Dep | | | | | | | | | | | | | | | | | | | | | | | | 4 | 2 |
| OFF GATE 17 | RON Offgate | | | B-737-900WL | MD-80 | | Grp III Arr/Dep | | | | | | | | | | | | | | | | | | | | | | | | 2 | 1 |
| OFF GATE 18 | RON Offgate | | | B-737-900WL | MD-80 | | Grp III Arr/Dep | | | | | | | | | | | | | | | | | | | | | | | | 4 | 2 |
| OFF GATE 19 | RON FIS gate | | | B-737-900WL | MD-80 | | Grp III Arr/Dep | | | | | | | | | | | | | | | | | | | | | | | | 3 | 1.5 |
| OFF GATE 20 | RON Offgate | | | B-737-900WL | MD-80 | | Grp III Arr/Dep | | | | | | | | | | | | | | | | | | | | | | | | 2 | 1 |
| OFF GATE 21 | RON Offgate | | | B-737-900WL | MD-80 | | Grp III Arr/Dep | | | | | | | | | | | | | | | | | | | | | | | | 2 | 1 |
| OFF GATE 22 | RON Offgate | | | B-737-900WL | MD-80 | | Grp III Arr/Dep | | | | | | | | | | | | | | | | | | | | | | | | 2 | 1 |
| OFF GATE 23 | RON Offgate | | | B-737-900WL | MD-80 | | Grp II Arr/Dep | | | | | | | | | | | | | | | | | | | | | | | | 3 | 1.5 |
| OFF GATE 24 | RON Offgate | | | B-737-900WL | MD-80 | | Grp III Arr/Dep | | | | | | | | | | | | | | | | | | | | | | | | 2 | 1 |
| OFF GATE 25 | RON Offgate | | | B-737-900WL | MD-80 | | Grp III Arr/Dep | | | | | | | | | | | | | | | | | | | | | | | | 2 | 1 |
| OFF GATE 26 | RON Offgate | | | B-737-900WL | MD-80 | | Grp II Arr/Dep | | | | | | | | | | | | | | | | | | | | | | | | 3 | 1.5 |
| OFF GATE 27 | RON FIS gate | | | B-737-900WL | MD-80 | | Grp III Arr/Dep | | | | | | | | | | | | | | | | | | | | | | | | 4 | 2 |
| OFF GATE 28 | RON Offgate | | | B-737-900WL | MD-80 | | Grp III Arr/Dep | | | | | | | | | | | | | | | | | | | | | | | | 4 | 2 |
| OFF GATE 29 | RON Offgate | | | B-737-900WL | MD-80 | | Grp III Arr/Dep | | | | | | | | | | | | | | | | | | | | | | | | 2 | 1 |
| OFF GATE 30 | RON FIS gate | | | B-737-900WL | MD-80 | | Grp III Arr/Dep | | | | | | | | | | | | | | | | | | | | | | | | 2 | 1 |
| OFF GATE 31 | RON FIS gate | | | B-737-900WL | MD-80 | | Grp III Arr/Dep | | | | | | | | | | | | | | | | | | | | | | | | 2 | 1 |
| OFF GATE 32 | RON FIS gate | | | B-737-900WL | MD-80 | | Grp III Arr/Dep | | | | | | | | | | | | | | | | | | | | | | | | 2 | 1 |
| OFF GATE 33 | RON FIS gate | | | B-737-900WL | MD-80 | | Grp III Arr/Dep | | | | | | | | | | | | | | | | | | | | | | | | 2 | 1 |
| OFF GATE 34 | RON Offgate | | | B-737-900WL | MD-80 | | Grp III Arr/Dep | | | | | | | | | | | | | | | | | | | | | | | | 2 | 1 |
| OFF GATE 35 | RON Offgate | | | B-737-900WL | MD-80 | | Grp III Arr/Dep | | | | | | | | | | | | | | | | | | | | | | | | 3 | 1.5 |
| OFF GATE 36 | RON FIS gate | | | B-737-900WL | MD-80 | | Grp III Arr/Dep | | | | | | | | | | | | | | | | | | | | | | | | 2 | 1 |
| OFF GATE 37 | RON FIS gate | | | B-737-900WL | MD-80 | | Grp III Arr/Dep | | | | | | | | | | | | | | | | | | | | | | | | 2 | 1 |
| OFF GATE 38 | RON FIS gate | | | B-737-900WL | MD-80 | | Grp III Arr/Dep | | | | | | | | | | | | | | | | | | | | | | | | 3 | 1.5 |

2034 Ramp Chart

| Position | Based on 'Mix B' assuming the largest aircraft size mix | Jet Type | Jet Type Count | Max Wingspan Acft | Max Length Acft | Depend Group |
|-------------|---|----------|----------------|-------------------|-----------------|--------------|
| OFF GATE 39 | RON FIS gate | | | B-737-900WL | MD-80 | |
| OFF GATE 40 | RON Offgate | | | B-737-900WL | MD-80 | |
| OFF GATE 41 | RON FIS gate | | | B-737-900WL | MD-80 | |
| OFF GATE 42 | RON Offgate | | | B-777-300ER | | |
| OFF GATE 43 | RON Offgate | | | B-777-300ER | | |
| OFF GATE 44 | RON Offgate | | | B-777-300ER | | |
| OFF GATE 45 | RON Offgate | | | B-777-300ER | | |
| OFF GATE 46 | RON Offgate | | | B-777-300ER | | |
| OFF GATE 47 | RON Offgate | | | B-777-300ER | | |
| OFF GATE 48 | RON Offgate | | | B-767-300ERWL | | |
| OFF GATE 49 | RON Offgate | | | B-737-900WL | MD-80 | |
| OFF GATE 50 | RON Offgate | | | B-737-900WL | MD-80 | |
| OFF GATE 51 | RON Offgate | | | B-737-900WL | MD-80 | |
| OFF GATE 52 | RON Offgate | | | B-737-900WL | MD-80 | |
| OFF GATE 53 | RON Offgate | | | B-737-900WL | MD-80 | |
| OFF GATE 54 | RON Offgate | | | B-737-900WL | MD-80 | |
| OFF GATE 55 | RON FIS gate | | | B-737-900WL | MD-80 | |
| OFF GATE 56 | RON Offgate | | | B-737-900WL | MD-80 | |
| OFF GATE 57 | RON Offgate | | | B-737-900WL | MD-80 | |
| OFF GATE 58 | RON FIS gate | | | B-737-900WL | MD-80 | |
| OFF GATE 59 | RON Offgate | | | B-737-900WL | MD-80 | |
| OFF GATE 60 | RON Offgate | | | E-190 | CRJ-900 | |
| OFF GATE 61 | RON FIS gate | | | E-190 | CRJ-900 | |
| OFF GATE 62 | RON FIS gate | | | E-190 | CRJ-900 | |
| OFF GATE 63 | RON FIS gate | | | E-190 | CRJ-900 | |
| OFF GATE 64 | RON Offgate | | | E-190 | CRJ-900 | |
| OFF GATE 65 | RON Offgate | | | E-190 | CRJ-900 | |

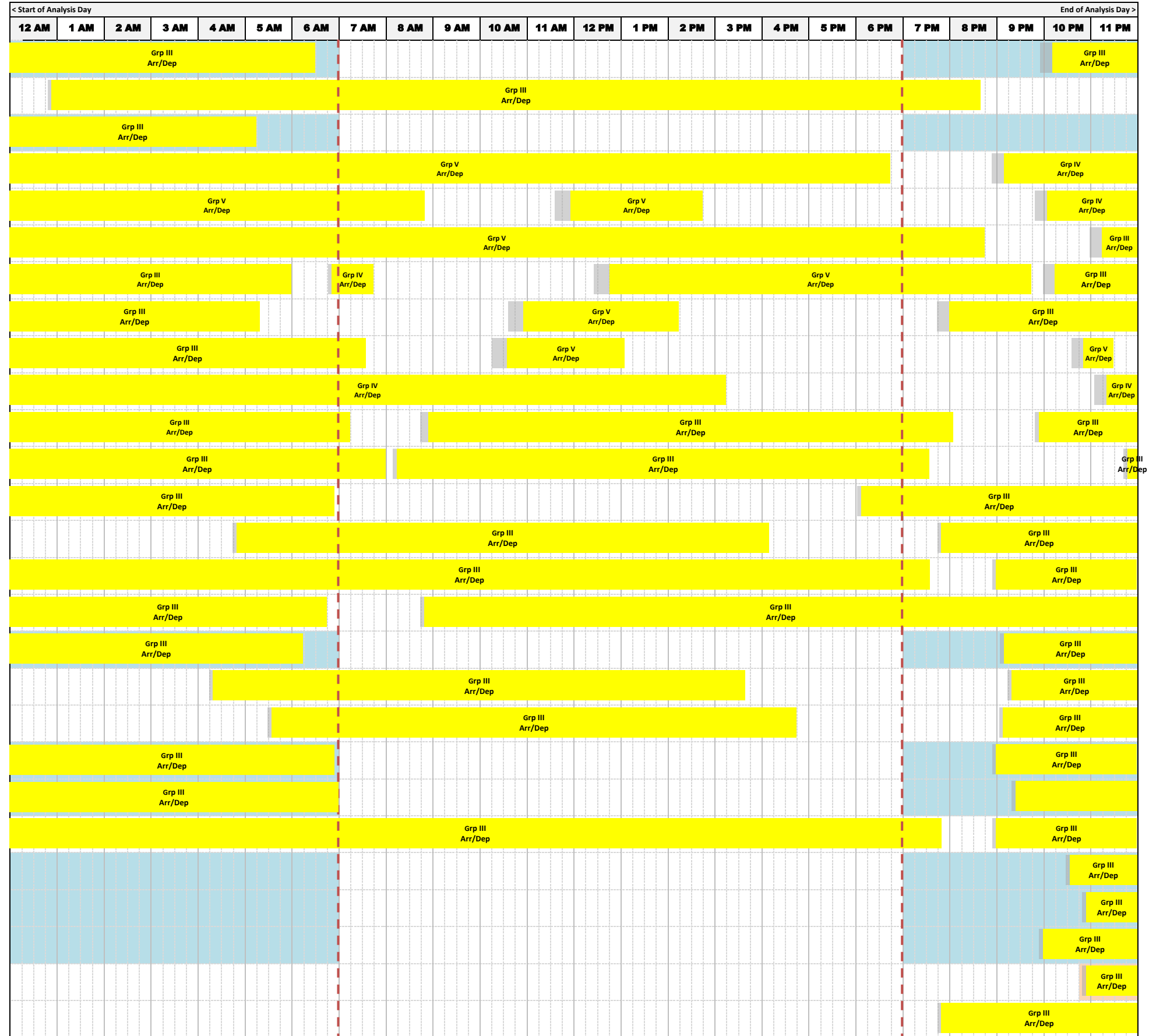

| Arr + Dep | Turns |
|-----------|-------|
| 3 | 1.5 |
| 2 | 1 |
| 2 | 1 |
| 2 | 1 |
| 2 | 1 |
| 4 | 2 |
| 2 | 1 |
| 6 | 3 |
| 4 | 2 |
| 5 | 2.5 |
| 2 | 1 |
| 4 | 2 |
| 4 | 2 |
| 2 | 1 |
| 3 | 1.5 |
| 2 | 1 |
| 2 | 1 |
| 2 | 1 |
| 2 | 1 |
| 2 | 1 |
| 2 | 1 |
| 1 | 0.5 |
| 1 | 0.5 |
| 2 | 1 |
| 1 | 0.5 |
| 1 | 0.5 |
| 1 | 0.5 |
| 1 | 0.5 |
| 1 | 0.5 |

2034 Ramp Chart

| Position | Based on 'Mix B' assuming the largest aircraft size mix | Jet Type | Jet Type Count | Max Wingspan Acft | Max Length Acft | Depend Group |
|-------------|---|----------|----------------|-------------------|-----------------|--------------|
| OFF GATE 66 | RON Offgate | | | E-190 | CRJ-900 | |

| < Start of Analysis Day | | | | | | | | | | | | | | | | | | | | | End of Analysis Day > | | | |
|-------------------------|------|------|------|------|------|------|------|------|------|-------|-------|-------|------|------|------|------|------|------|------|------|-----------------------|-------|-------|--------------------|
| 12 AM | 1 AM | 2 AM | 3 AM | 4 AM | 5 AM | 6 AM | 7 AM | 8 AM | 9 AM | 10 AM | 11 AM | 12 PM | 1 PM | 2 PM | 3 PM | 4 PM | 5 PM | 6 PM | 7 PM | 8 PM | 9 PM | 10 PM | 11 PM | |
| | | | | | | | | | | | | | | | | | | | | | | | | Grp III Arr/Dep |

| Arr + Dep | Turns |
|-----------|-------|
| 1 | 0.5 |